

IVC series PLC/VT series HMI

Innovation, Value, Teamwork



INVT Auto-Control Technology (Shenzhen) Co., Ltd.

Address (Headquarters): 1# Bldg, Gaofa Technological Park, Longjing, Nanshan District, Shenzhen

Address (factory in Fuyong): Bldg A, Zone A, Juyuan Industrial Park, Tangwei Village, Fuyong, Bao'an District, Shenzhen

Website: www.invt-control.com

Information may be subject to change without notice during product improving.

201408(V1.3)



Company profile



INVT is committed to being the globally leading and respected provider for products and services of industrial automation and electric power. In 2010, it was listed as an A-share company on Shenzhen Stock Exchange. INVT is a national-level high-tech company, whose main products involve high, medium and low voltage inverter, elevator intelligent integrated machine, PLC, HMI, servo system, motor and electric spindle, SVG, UPS, solar inverter, etc.

INVT Auto-Control Technology (Shenzhen) Co., Ltd is a subsidiary company invested by Shenzhen INVT Electric Co., Ltd. As an integrated high-tech enterprise, it specializes in the R&D, production, sales and service on industrial automation, and has many experienced technicians who have been working in the field for many years. On the basis of powerful technical strength, advanced production equipment and improved service system, we strive to be the leading international supplier of industrial control and automation through an unyielding commitment of innovation, diligent research and development.

Corporate Concept

- ◆ **Business Concept:** Sincere, Credit standing, Professional and Ambitious
- ◆ **Company vision:** To be the globally leading and respected provider for products and services of industrial automation and electric power
- ◆ **Corporate Mission:** Make all efforts to offer value-added products and services to strengthen client's competitive advantages.
- ◆ **Core Values:** Work together and keep improving



INVT automation solution

In the feature of high speed, stability, reliability and price performance, INVT IVC series PLC is widely used in industrial automation field. It has large capacity memory, fast operation speed, rich instructions, multiple extension functions and various communication ports. By the simple and effective connection of INVT HMI, inverter, servo, temperature controller and intelligent instrument through industrial network, it provides users with the best industrial automation solution.

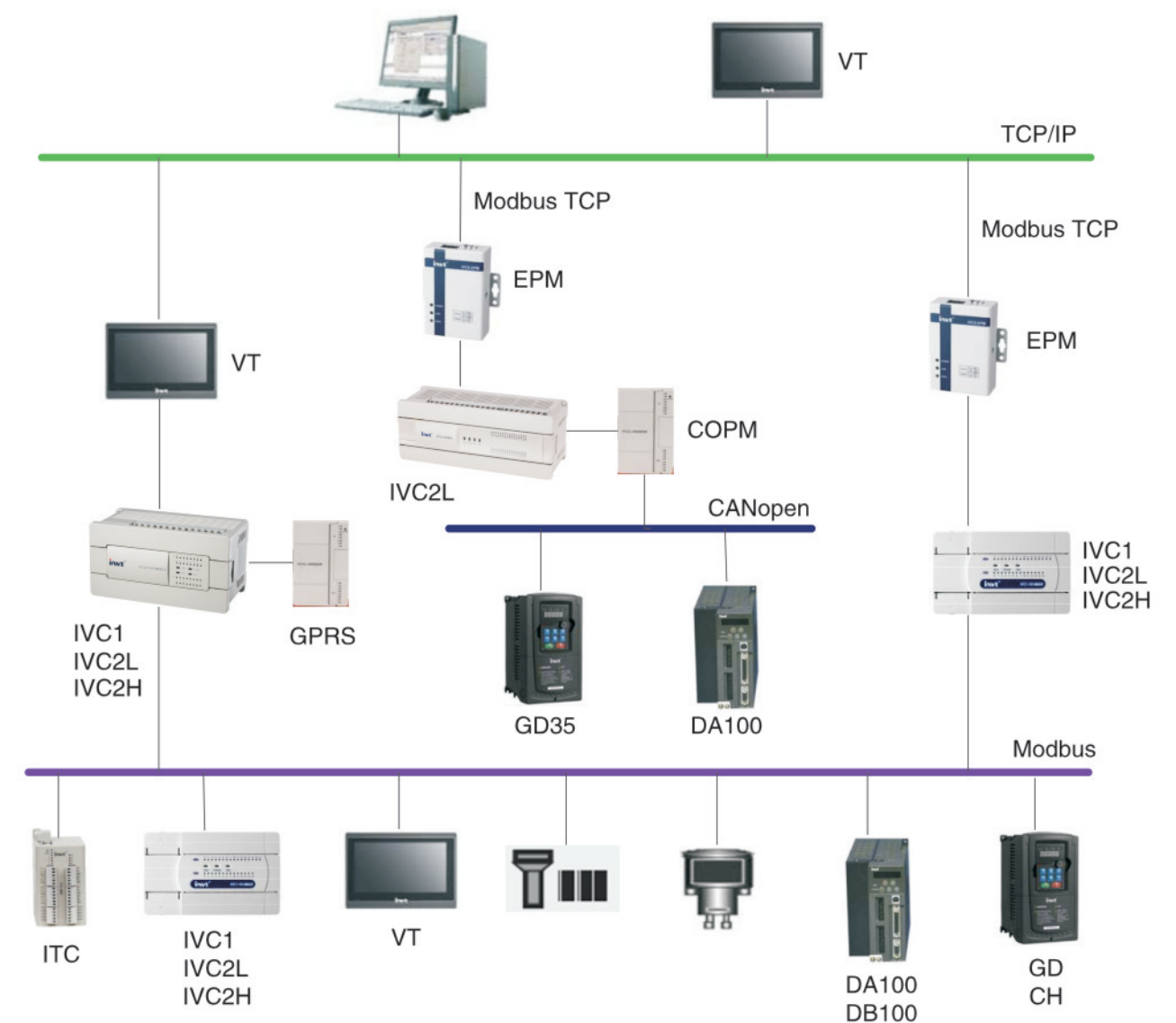

IVC series PLC products

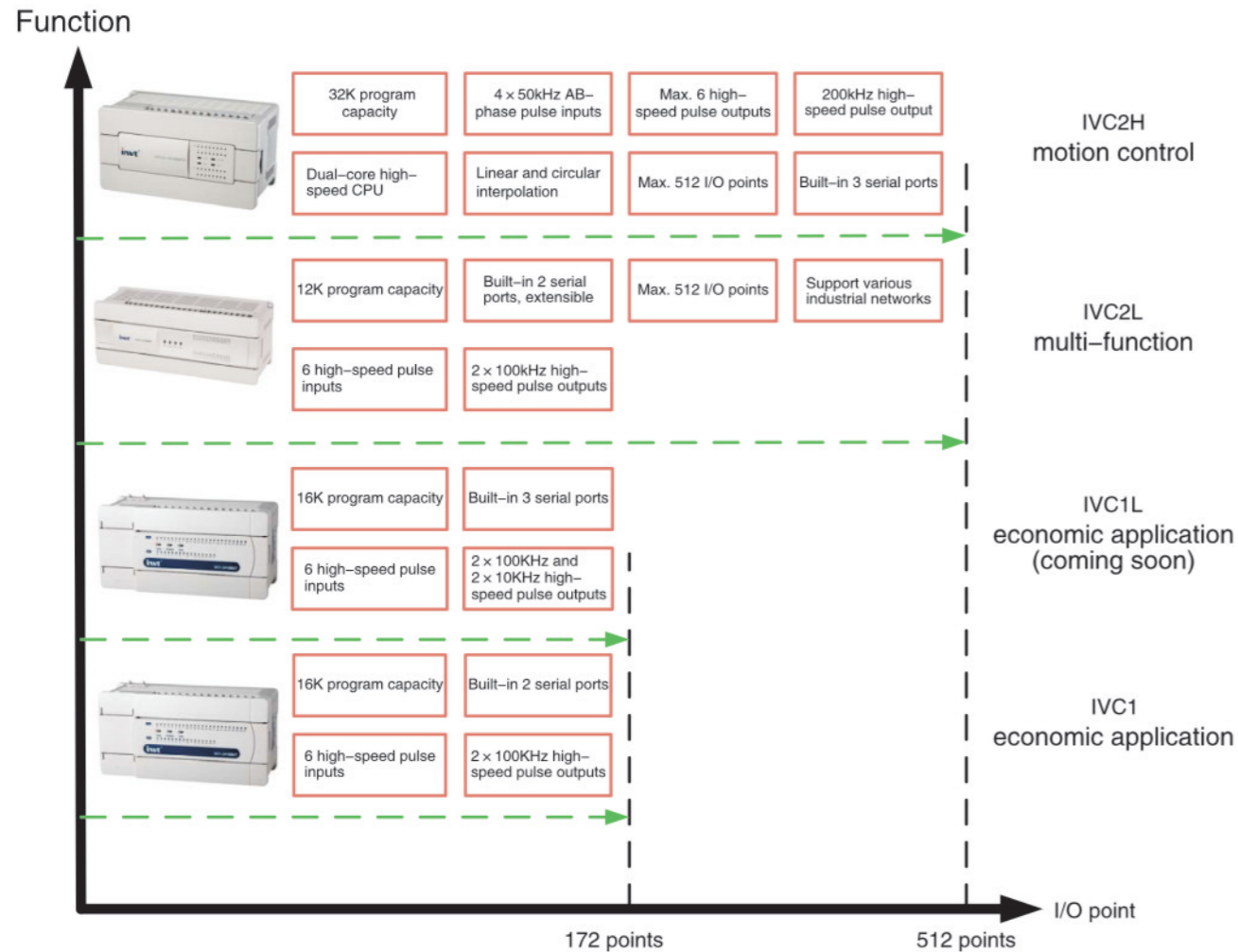

IVC1 small PLC

IVC1 series PLC is a small high-performance PLC with small structure, powerful functions and high price-performance. It can be widely used in the mechanical manufacture industries such as textile fiber, machine tools, cables, foods and drinks, packages, plastics and steels, buildings, air conditioners, elevators and printing.

- Small size, high configuration, high-capacity and fast speed
- Strong positioning and high-speed processing capability
- Strong communication
- Powerful programmable software

IVC2 small PLC

IVC2 series PLC is a small multi-functional PLC with powerful communication capability, strong system extension capability and rich high-speed I/O functions, stably and reliably.

- Max. 512 I/O points
- Support various industrial networks
- Rich extension modules
- Max. 4 AB-phase high-speed pulse inputs and 6 high-speed pulse outputs, linear and circular interpolation

IVC1 series small PLC

Modules



10-point input and 6-point output
14-point input and 10-point output
16-point input and 14-point output
24-point input and 16-point output
36-point input and 24-point output



8-point input and 8-point output
16-point input
16-point output



2 / 4 analog inputs
2 / 4 analog outputs
2 / 4 thermal resistors
2 / 4 thermocouples
4 analog inputs and 1 analog output

Main modules

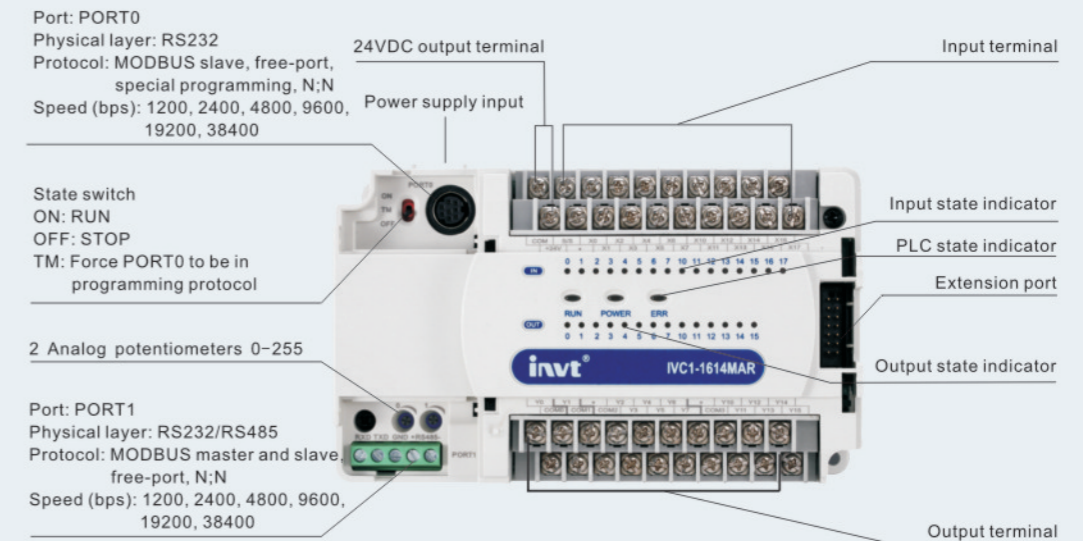

I/O extension modules

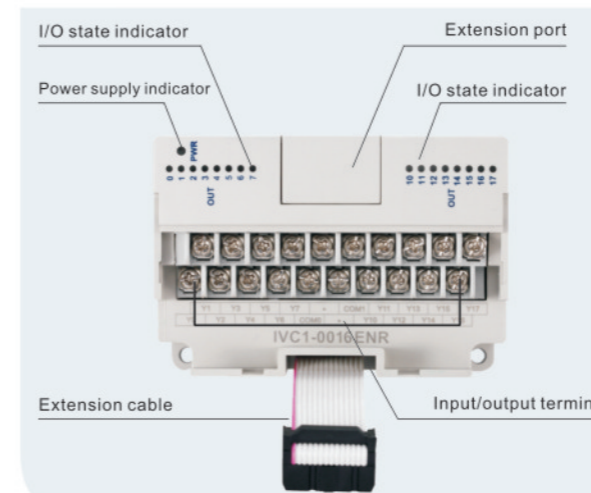

Special function modules

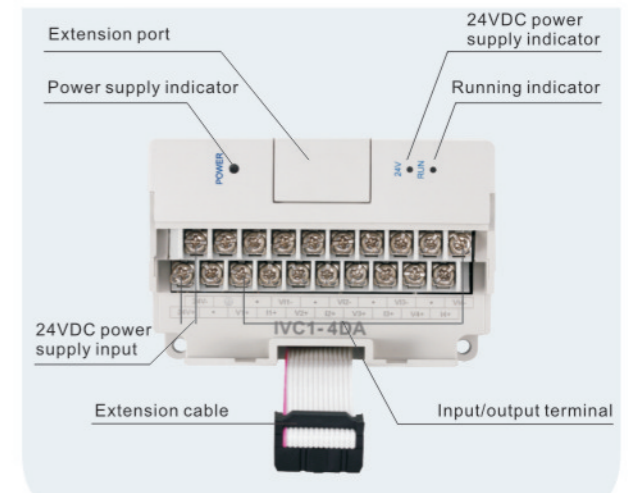

IVC1 main module for special functions

IVC1 main module of integrated analog I/O



- > Particularly suitable for small-point analog applications
- > Control analog without extension
- > Possess all functions of IVC1

IVC1-1614MAR1、IVC1-1614MAT1

16-point DC24V input, 14-point relay/transistor output
2 analog inputs, 1 analog output

IVC1-0808MAR1、IVC1-0808MAT1

8-point DC24V input, 8-point relay/transistor output
6 analog inputs, 1 analog output
(4 analog inputs can be optional for μ A signals)

IVC2L/IVC2H series small PLC



IVC2L main module: 32 points, 64 points

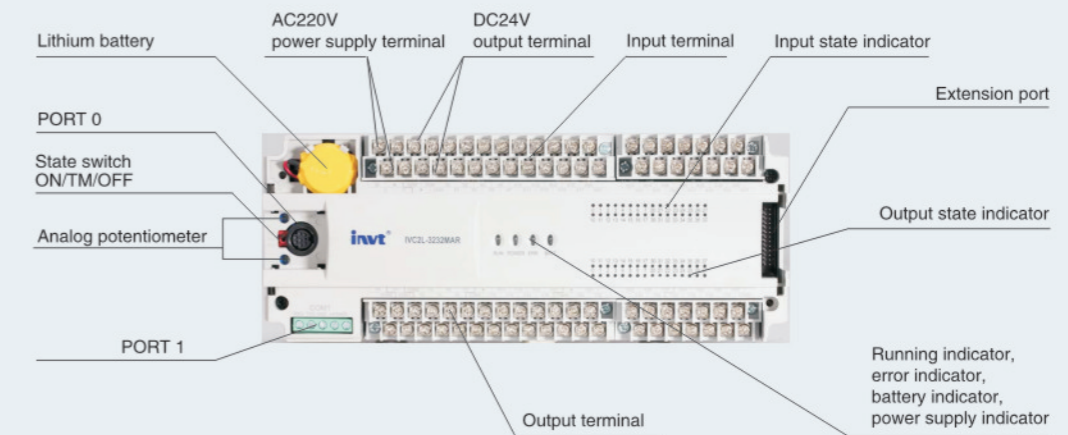

IVC2H main module: 32 points (4-axis or 6-axis positioning)

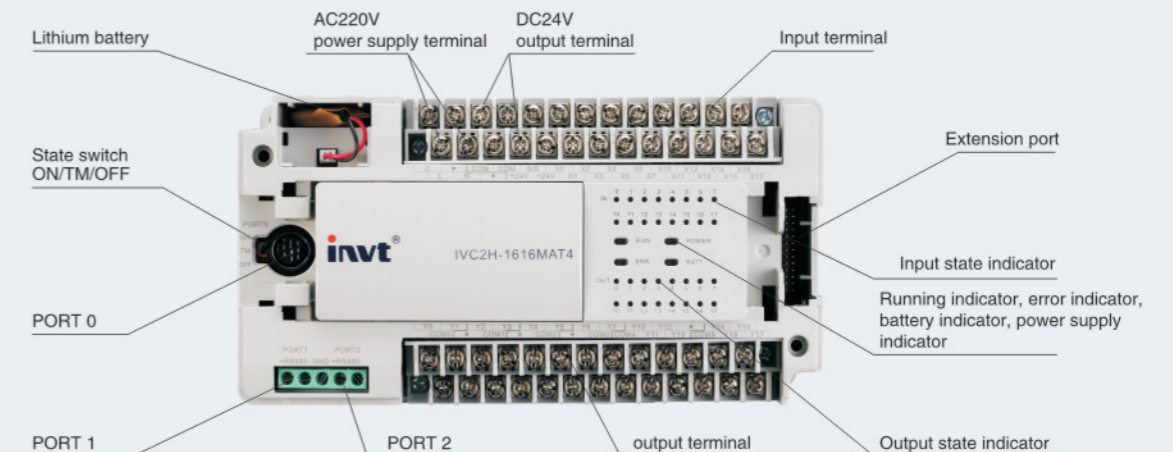

I/O extension module

- 16-point input module
- 16-point output module
- 8-point input and 8-point output module
- 16-point input and 16-point output module



Special function module

- Module for 4/8 analog inputs
- Module for 4 analog outputs
- Temperature module for 4 thermal resistors
- Temperature module for 4 thermocouples



Communication extension module

- RS 485 extension module IVC2L-RS485
- CANopen master module IVC2L-COPM
- GPRS module IVC2L-GPRS
- Ethernet adapter IVCS-EPM

I/O extension module

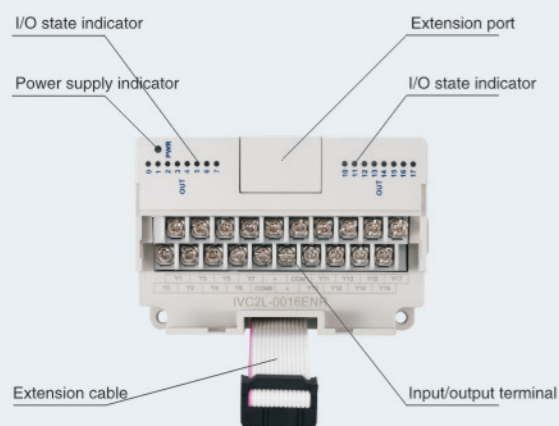

Special function module

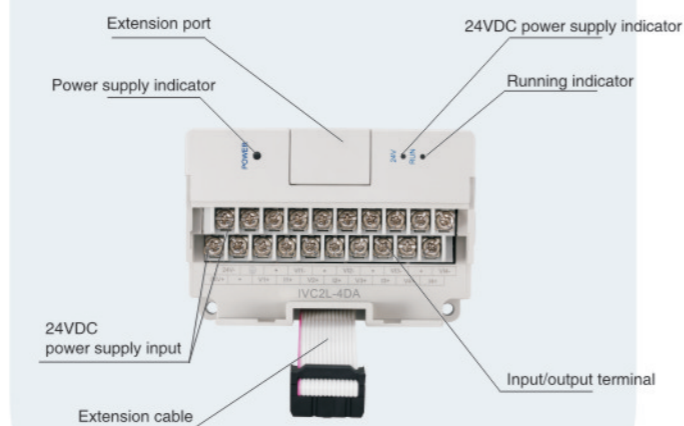

Communication extension module

CANopen master module: IVC2L-COPM

IVC2L-COPM communication module is connected to IVC2L series PLC as an extension module, providing a CANopen master.

1. Compliant with CANopen standard protocol DS301v4.02
2. Supportive of NMT service
3. Supportive of Error Control Protocol
4. Supportive of SDO protocol
5. Supportive of EDS file configuration in CANopen configuration software
6. Supportive of PDO service: Max. 32 RxPDOs, 32 TxPDOs
7. PDO transmission type: supporting incident trigger, time trigger, synchronous and asynchronous periods
8. Simple setting and easy to use in the system of PLC programming software

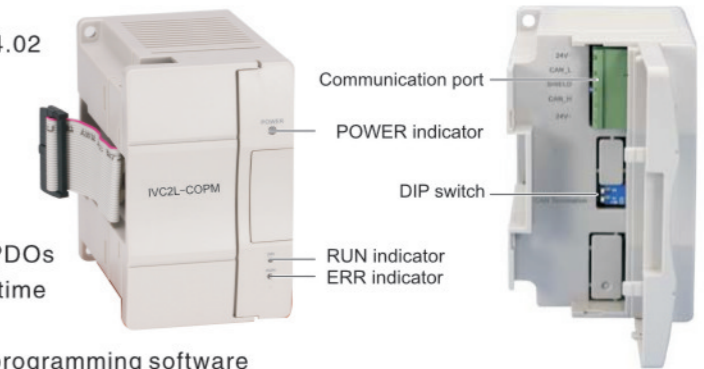

Parameter	Description	Parameter	Description
Transmission standard	CAN2.0A	Isolation type	Opto-coupler isolation
Communication on port type	5-pin open style connection	Supported protocol	0 (Non-Profile)
Information type	PDO, SDO, SYNC, Emergency, NMT	Communication mode	Synchronous cyclic, asynchronous, synchronous non-cycle
Network capacity	Max. number of nodes in the network is 32	Addressing range	127 (fixed)
Baudrate	10k 20k 50k 125k 250k 500k 800k 1M		
Max. transmission distance (m)	5000 2500 1000 500 250 100 50 25		

Rs485 extension module: IVC2L-RS485

IVC2L-RS485 communication module is connected to IVC2L series PLC as an extension module, providing an isolated Rs485 communication interface between IVC2L series PLC system and other RS485 equipment.

Parameter	Description
Transmission standard	RS485
Isolation type	Optocoupler isolation
Bus port type	5-pin terminal block (Euro style)
Communication mode	Semi-duplex/full-duplex
Supported protocol	Free port protocol, MODBUS protocol
Addressing range	Free port protocol: no address MODBUS network address: 1~247
Network capacity	Max. number of network nodes: 31
Communication baud rate	Users can set it freely, Max. 115.2kbps
Max. transmission distance	1000m

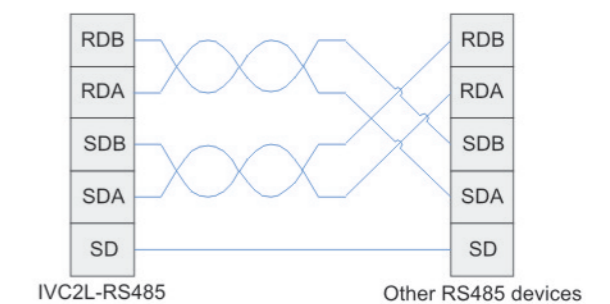
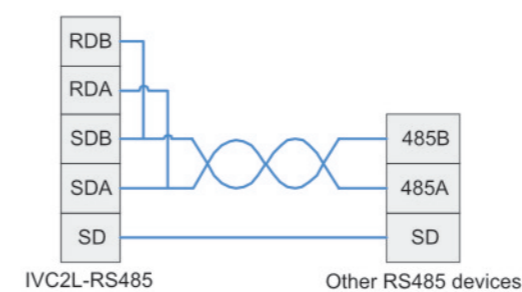
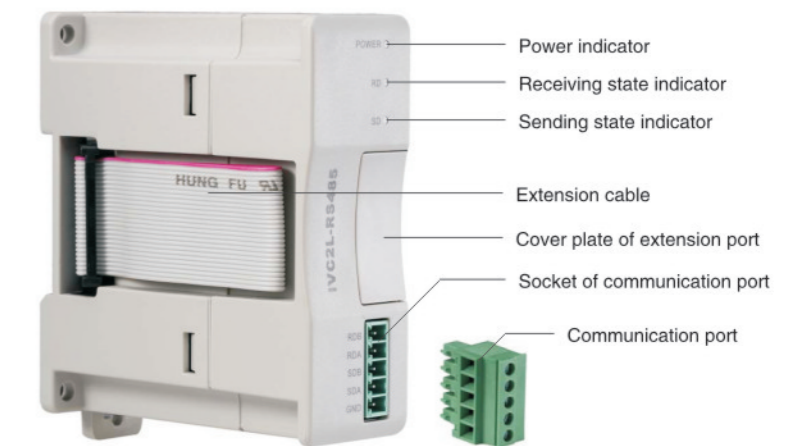

GPRS module: IVC2L-GPRS

IVC2L-GPRS module is connected to IVC2L/IVC2H series PLC as an extension module and it can also be connected to IVC1 series PLC via RS485, providing data channel for PLC connected to Internet and realizing wireless data exchange, SMS control.

Basic functions

- ① GSM/GPRS band, quad band (900/1800, 850/1900MHz), support G network operators such as WCDMA and TD-SCDMA
- ② Chinese/English SMS, TCP/UDP internet access
- ③ One data center and one standby data center, the access method supports IP address and dynamic DNS
- ④ Support SMS and PLC wakeup function
- ⑤ Always online, idle offline, reconnection after disconnection, configurable beat interval
- ⑥ Local graphical configuration tool for configuring parameters
- ⑦ SMS parameter configuration, inquiry, modification (stop, run PLC) and alarm (arrears, customized alarm group)
- ⑧ Support remote upgrade debugging for user program of PLC main module
- ⑨ Support GPS positioning
- ⑩ The data center supports mainstream configuration software

Note: The operations such as SMS access, parameter modification and remote upgrade need password permissions.



	Parameter	Description
Wireless basic attribute	Band	GSM 850MHz E-GSM 900MHz DCS 1800MHz PCS 1900MHz
	Technical specification	SMG31bis
	Data packet exchange rate	GPRS multi-slot class 10 Coding scheme CS1-CS4 Up to 85.6 kb/s DL Up to 42.8 kb/s UL
	Available protocol	TCP/IP, UDP
Interface communication attribute	RS485 communication	115200bps
	RS232 communication	9600bps

Ethernet adapter IVCS-EPM

IVCS-EPM communication adapter, the conversion and transmission device for Ethernet TCP/IP protocol to RS232/485 serial port, can change traditional serial communication to network communication and realize quick internet access for serial devices. Its simple and flexible configuration and high reliability can meet the needs of Ethernet remote control.

Ethernet specification

Project	Specification
Interface type	RJ-45
Transmission mode	IEEE802.3
Transmission rate	10Mbps
Isolation protection	1.5KV isolation
Communication protocol	ICMP, ARP, IP, TCP, UDP, DHCP, Modbus TCP, remote programming interface protocol

Serial communication specification

Project	Specification
Interface type	DB9
Transmission mode	RS232/RS485 (only one is available at the same time)
Transmission rate	1200, 2400, 4800, 8600, 19200, 38400, 57600, 115200
Isolation protection	Modbus TCP, remote programming interface protocol



Product configuration

Small size, high configuration, large capacity, fast speed

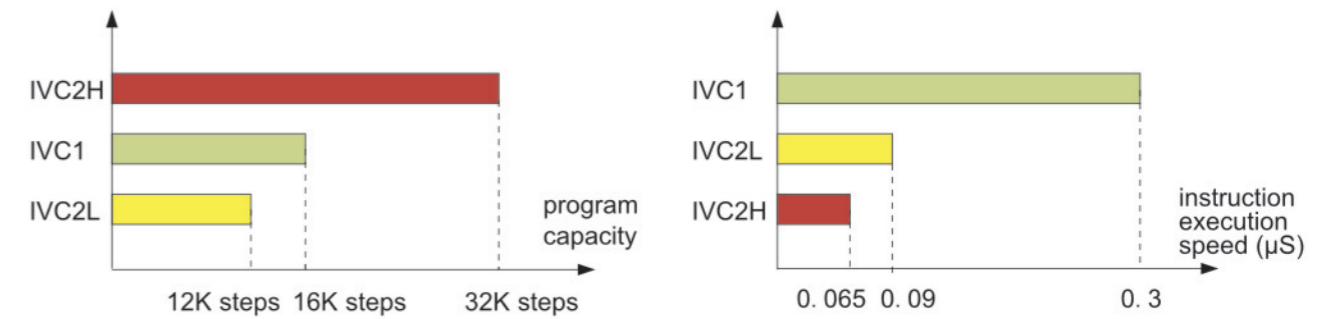

Series	Max. I/O points	Max. special function modules
IVC1	172	7
IVC2L/IVC2H	512	8

High reliability and high stability

- > Extra wide operation voltage: AC85V to 264V
- > Strict protection mechanism (protection against moisture, corrosion, mould) of boards enable the product to adapt severe field conditions
- > Excellent capability of immunity to disturbance
- > User program can be stored in EEPROM permanently
- > IVC2 all series use batteries for power-off data storage and clock, IVC1 clock uses super capacitors for storage and the power-off data will be saved permanently in Flash (IVC1 upgraded version uses batteries)
- > EEPROM write instruction

Safer user program

- > Strong encryption function, making user program safer

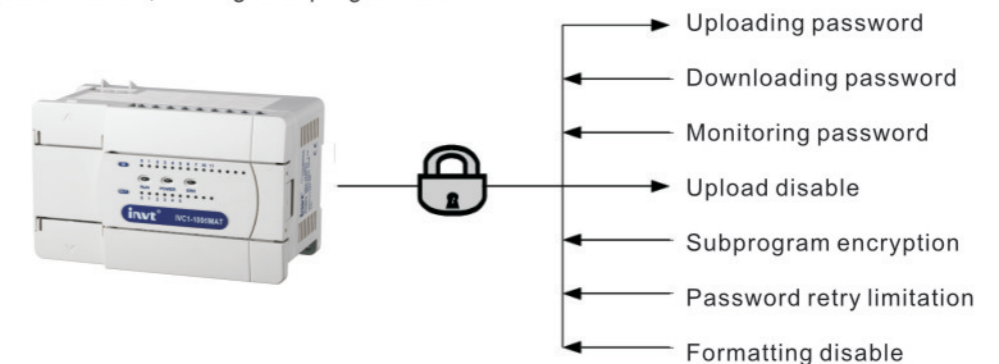

Positioning and high-speed pulse processing

- > Built-in high-speed counter, support single-phase single counting, single-phase increasing/decreasing counting and dual-phase counting
- > The main module provides 2 or 3 (IVC1/IVC2L) and 4 or 6 (IVC2H) independent pulse outputs

PTO: Duty cycle 50% pulse signal frequency

PWM: Adjustable duty cycle cycle pulse width

X0-X7

- > High-speed counting
- > Frequency detection
- > Pulse capture

Y0 Y1 100kHz 100kHz

High-speed processing is not affected by CPU scan time

Max. 6 channels

High-speed counting

- > Single-phase counting: IVC1/IVC2L: 2 × 50KHz, 4 × 10KHz IVC2H: 8 × 100kHz
- > Dual-phase counting: IVC1/IVC2L: 1 × 30KHz, 1 × 5KHz IVC2H: 4 × 50KHz

Pulse output

- > Pulse output: IVC1/IVC2L: 2 × 100KHz IVC2H: 2 × 200KHz, 2 or 4 × 100KHz
- > Support pulse train output (PTO) and pulse width modulation (PWM)
- > IVC2H supports linear and circular interpolation

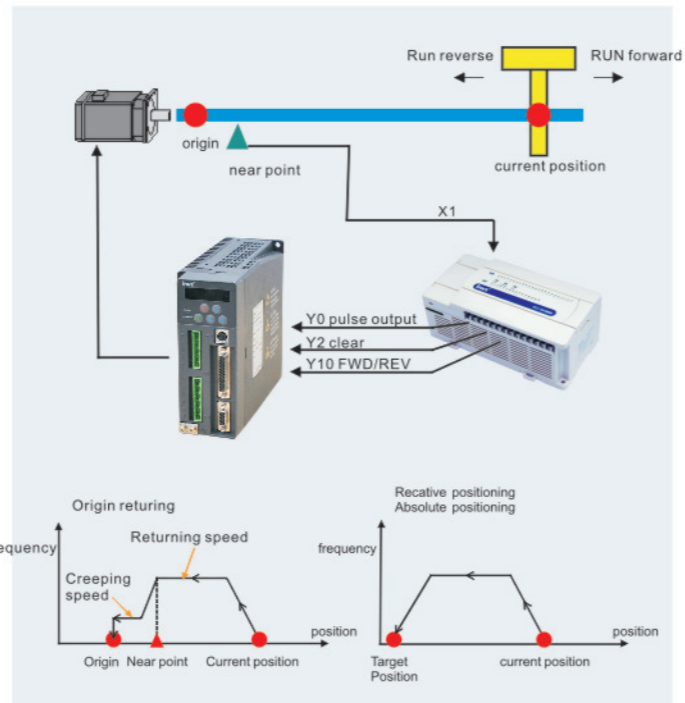

Communication networking

Device connection

- > Provide two or three communication ports, support various built-in communication protocols, support various networking modes

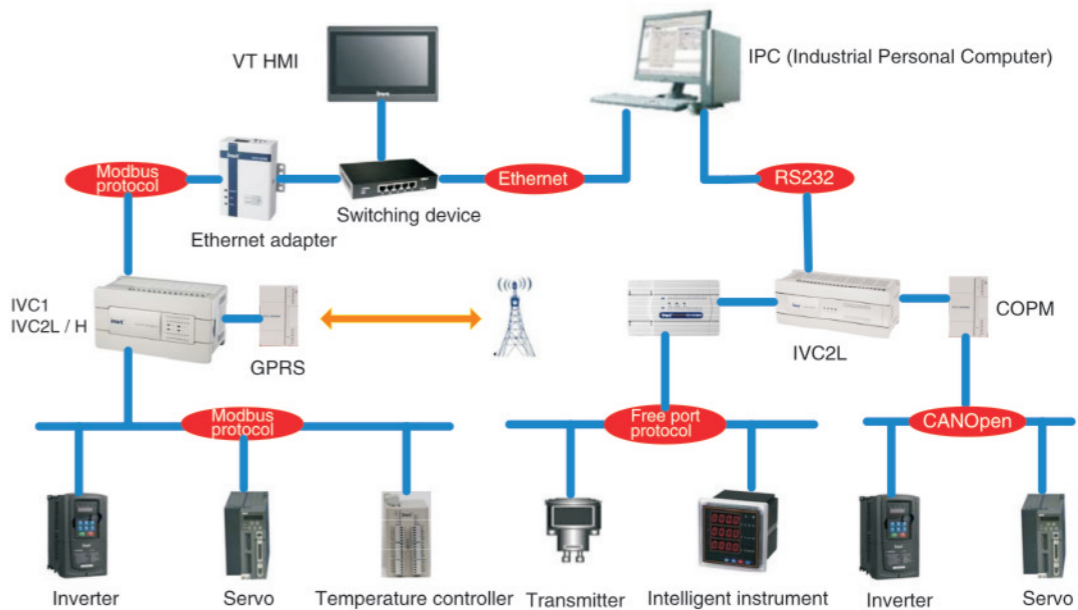

N: N network

- > Network between Multiple PLC can make the access to specified M and D components dates available. It is particularly suitable for the interlock between the distributed related in control system. This is no need of programming if applies N:N protocol.

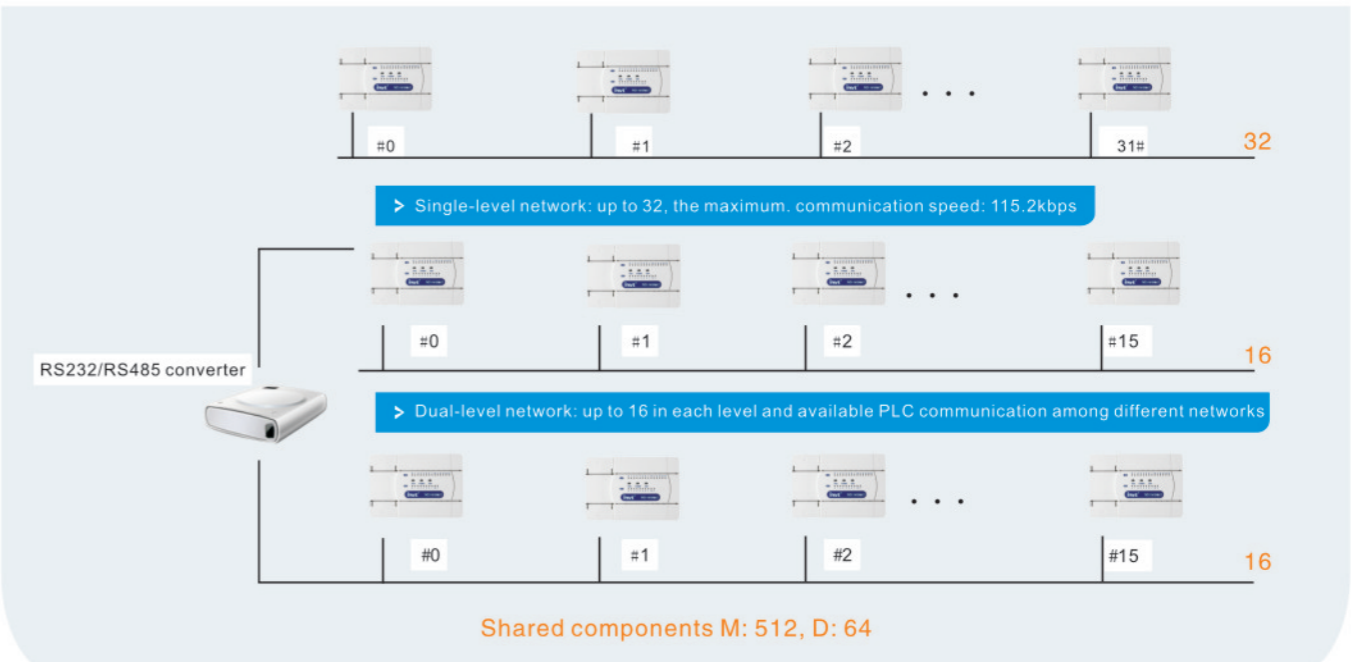

IVC2H features

Dual-core processing, computation speed and performance improve greatly

- > Dual-core, high speed and independent processing of motion control algorithm
- > Multi-task parallel execution
- > Basic instruction processing speed <math>< 0.065\mu s</math>

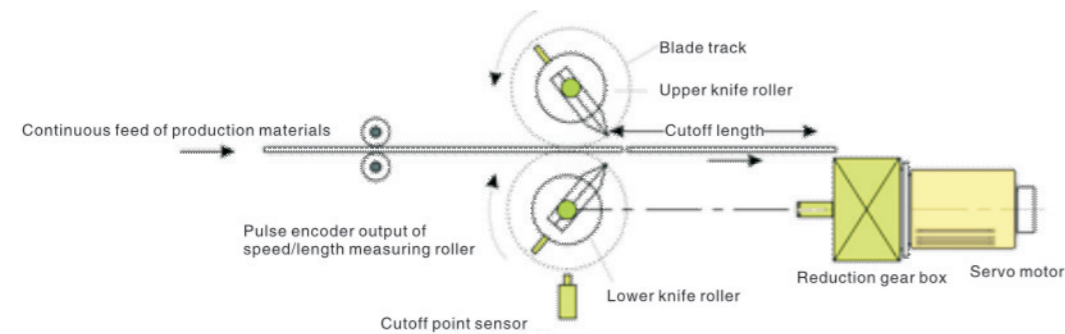

Strong high-speed input and output functions

- > 8 × 100kHz single-phase high-speed pulse inputs, or 4 × 50kHz AB-phase pulse inputs, with the function of 4 frequency doubling
- > 2 200kHz pulse outputs, 2 or 4 × 100kHz pulse outputs, support pulse+direction or positive pulse + negative pulse
- > Support linear and circular interpolation

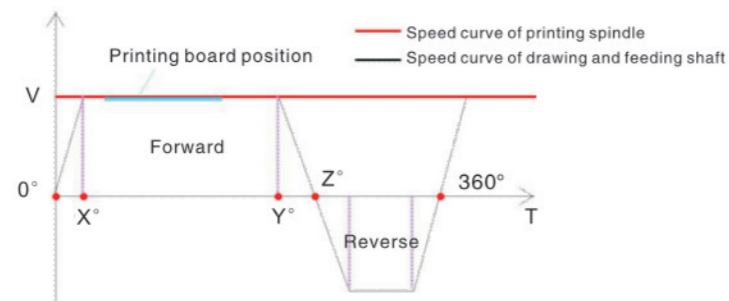

Strong communication networking capability

- > Built-in 3 serial ports and compatible with IVC2L series communication extension module and Ethernet adapter

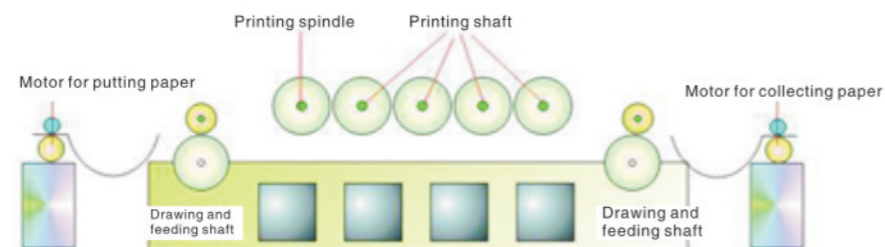

Enhanced positioning control

- DSZR with DOG automatic search
Capable of returning to the origin at any position

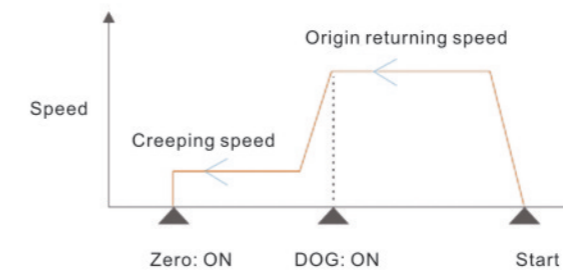

- PLSV with acceleration and deceleration
The speed can change at any time in running and support acceleration/deceleration, smoother

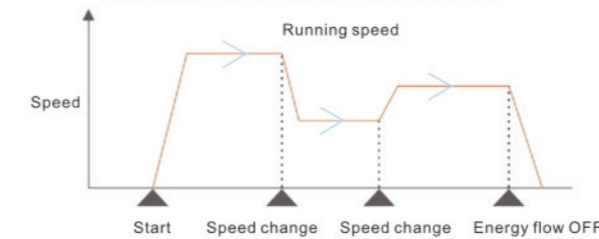

- Relative positioning/absolute positioning (DRVI/DRVA)
Relative to the current position or origin movement, with acceleration/deceleration



- 60-level PLSB with base frequency
 - 60-level acceleration/deceleration, reducing impact on mechanical parts greatly and controlling servo or step motors to move more smoothly under lower noise
 - Start at the base speed larger than 0, adapt to various kinds of servo control

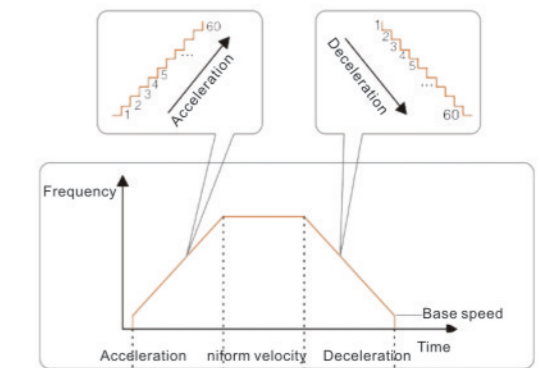

- Stop high-speed output
 - Support quick STOPDV of interrupt mode, not affected by scan time
 - Support all interrupt source triggering modes, flexible to apply

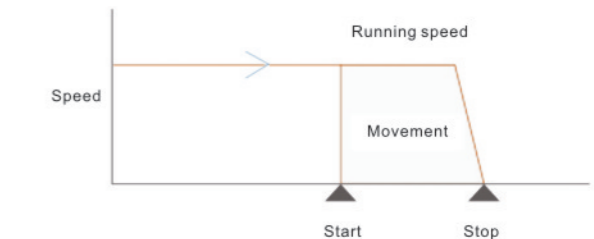

- Linear acceleration/deceleration, support triangle prevention
When the movement is small and the maximum speed is improper, it may cause immediate stop or deceleration to stop before reaching the maximum speed. Automatic triangle prevention has high accuracy, avoiding mechanical shock effectively.

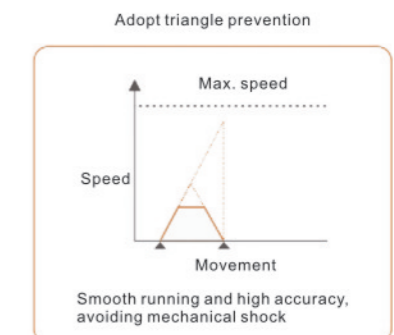
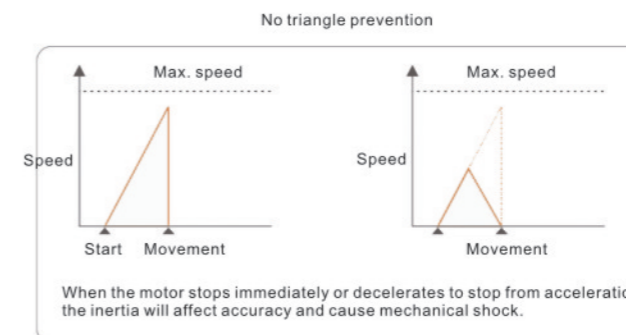

Accurate track control

- The interpolation realizes biaxial control at the same time and breaks through the barrier of small PLC
- The interpolation can be accurate to each pulse, the maximum speed is 100kHz, equivalent to professional motion controller
- The interpolation can be involved by 6 axes, among which Y4/Y5/Y6/Y7 supports the combination of any 2 axes, flexible in configuration

■ Linear interpolation (LIN)

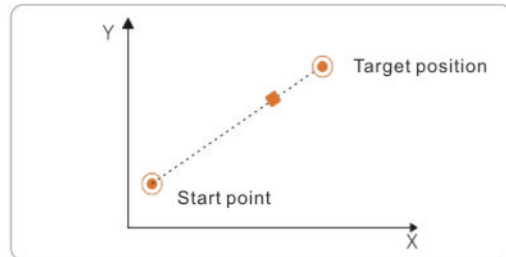

■ Circular interpolation (CW/CCW)

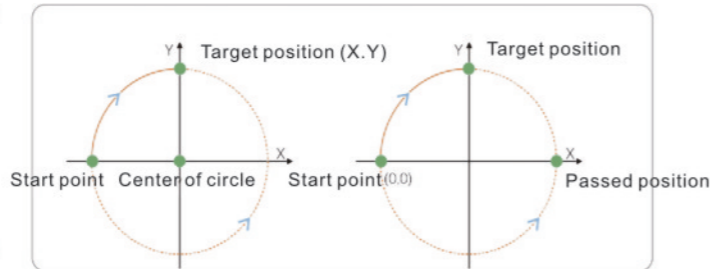

■ Combination of instruction LIN and CW/CCW

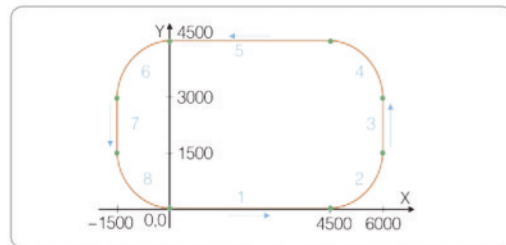

■ Max. interpolation speed: 100kHz

	IVC2H-1616MAT4 (4-axis)	IVC2H-1616MAT6 (6-axis)
Interpolation	Combination of Y0/Y1 and Y2/Y3 Combination of Y4 and Y5	Combination of Y0/Y1 and Y2/Y3 Combination of any 2 axes of Y4, Y5, Y6 and Y7

Specifications and technical parameters

Name		IVC2H	IVC2L	IVC1	
I/O	Digital I/O	16 inputs/16 outputs	20 inputs/12 outputs 32 inputs/32 outputs	10 inputs/6 outputs 14 inputs/10 outputs 16 inputs/14 outputs 24 inputs/16 outputs 36 inputs/24 outputs 8 inputs/8 outputs/6 analog inputs (4 channels can be optional for μ A signals)/1 analog output 16 inputs/14 outputs/2 analog inputs/1 analog output	
	Max. I/O	512	512	172	
	Max. special function modules	8	8	7	
	High-speed pulse output	2×200KHz, 4×100KHz (6-axis) or 2×200KHz, 2×100KHz (4-axis)	2×100KHz (only apply to transistor output)	2×100KHz (only apply to transistor output)	
	Single-phase counting channel	8×100KHz	2×50KHz+4×10KHz	2×50KHz+4×10KHz	
	Dual-phase counting channel	4×50KHz	1×30KHz+1×5KHz	1×30KHz+1×5KHz	
	Max. frequency sum of high-speed counter	800KHz	80KHz	60KHz	
	Digital filtering	X0-X7 adopt digital filtering, input filtering constant range: 0-60ms	X0-X17 adopt digital filtering, input filtering constant range: 0-60ms	X0-X7 adopt digital filtering, input filtering constant is selectable among 0, 2, 4, 8, 16, 32 and 64ms, 7 in total	
	Max. relay output current	Resistive load	2A/1 point; 8A/4 points, using a COM; 8A/8 points, using a COM		
		Inductive load	220Vac, 80VA		
Light load		220Vac, 100W			
Max. transistor output current	Resistive load	High-speed output point: 0.3A/1 point; other: 0.3A/1 point; 0.8A/4 points; 1.6A/8 points Above 8 points, total current increase 0.1A at 1 point increase			
	Inductive load	High-speed output point: 7.2W/24Vdc; other: 12W/24Vdc			
	Light load	High-speed output point: 0.9W/24Vdc; other: 1.5W/24Vdc			
Memory	User program	32k steps (64kByte)	12k steps (24kByte)	16k steps (32kByte)	
	Program power-off permanent storage	Yes			
	Max. hold components at power off	All soft components except R components	User setting	320 bit components, 180 word components	
	Hold time	Standby batteries, 3-year hold time	Standby batteries, 3-year hold time	EEPROM, permanent storage	
Soft component resource	Timer (T)	100ms accuracy: T0-T209 10ms accuracy: T210-T479 1ms accuracy: T480-T511	100ms accuracy: T0-T209 10ms accuracy: T210-T251 1ms accuracy: T252-T255		
	Counter (C)	16-bit increasing counter: C0-C199 32-bit increasing/ decreasing counter: C200-C235 32-bit high-speed counter: C236-C255, C301-C306	16-bit increasing counter: C0-C199 32-bit increasing/ decreasing counter: C200-C235 32-bit high-speed counter: C236-C255		
	Data register (D)	D0-D7999, R0-R32767	D0-D7999	D0-D7999	
	Local data register (V)	V0-V63			
	Indexed addressing register (Z)	Z0-Z15			
	Special data register (SD)	SD0-SD511	SD0-SD255		
	Auxiliary relay (M)	M0-M10239	M0-M1999	M0-M2047	
	Local auxiliary relay (LM)	LM0-LM63			
	Special auxiliary relay (SM)	SM0-SM511	SM0-SM255		

Electrical features of digital input

Name	IVC2H	IVC2L	IVC1
State relay (S)	S0~S4095	S0~S991	S0~S1023
Interrupt resource	Internal timer interrupt	3	3
	External timer interrupt	16	16
	High-speed counter interrupt	8	6
	Serial port interrupt	12	12
	PTO output interrupt	6	2
	Interpolation interrupt	3	/
	Passed position interrupt	6	/
General	Power loss interrupt	1	1
	Running time of basic instruction	0.065μS	0.09μS
	Realtime clock	Support (at least 3-year hold time at power off)	Support (100-hour hold time at power off)
Communication	Analog potentiometer	Without	2/8-bit accuracy
	Communication port	PORT0: RS232 PORT1: RS485 PORT2: RS485	PORT0: RS232 PORT1: RS232/RS485
Encryption measures	Communication protocol	Modbus/free port N: N/programming port protocol	
	Set password type	Uploading password, downloading password, monitoring password, subprogram password, prohibit formatting	
Application instruction	Prohibit uploading	Support	
	Realtime clock, clock instruction	Y	Y
	Date and clock compare instruction	Y	Y
	Floating point instruction	Y	Y
	Positioning instruction	Y	Y
	High-speed IO instruction	Y	Y
	MODBUS and inverter instruction	Y	Y
	Read and write EEPROM instruction	N	Y
	Computation control instruction	Y	Y
	String instruction	Y	N
MTBF	Batch data processing instruction	Y	N
	Data sheet instruction	Y	N
Contactlife of output relay	Relay output	200,000 hours (for ground fixation, mechanical stress close to zero, with temperature and humidity control) 100,000 hours (for ground fixation, mechanical stress close to zero, no temperature and humidity control)	
	Transistor output	300,000 hours (for ground fixation, mechanical stress close to zero, with temperature and humidity control) 150,000 hours (mechanical stress close to zero, no temperature and humidity control)	
Running environment	220Vac/15VA/ inductance	1s ON/1s OFF, 3,200,000 times	
	220Vac/30VA/ inductance	1s ON/1s OFF, 1,200,000 times	
	220Vac/72VA/ inductance	1s ON/1s OFF, 300,000 times	
Running environment	Rated voltage	IVC1: 100~240VAC/24VDC; IVC2L/IVC2H: 100~240VAC	
	Input voltage range	IVC1: 85~264VAC/19~30VDC(normal operation); IVC2L/IVC2H: 85~264VAC(normal operation)	
	Application temperature	-5~55°C	
	Storage temperature	-40~70°C	
	Withstand voltage	2830VAC or equivalent DC voltage 1 minute, no breakdown or flashover; leakage current ≤ 5mA	
	Shock	Displacement: 3.5mm, accelerated speed: 10m/s ² , frequency range: 5~150Hz, scan 10 times in XYZ direction	
	Impact	Half -sine, pulse width: 6ms, accelerated speed: 180m/s ²	
Certification	Pass the CE certification according to the standards of IEC61131-2 and UL508		

Electrical features of digital input

Project	High-speed input terminal X0~X7	Common input terminal
Input terminal	Input type	Source/sink are mode, but all the inputs must be the same
	Input impedance	3.3K~4.3K
	Output current	6.5mA TYP
	ON voltage/current	DC18V Min/4.5mA min
	OFF voltage/current	DC4V Max/1mA max
	Digital filtering time	Only X0-X7 are adjustable within the range of 0 to 64ms
	Pulse capture	X0-X7 can realize pulse capture, other ports have no such function

Electrical features of digital output

Project	Relay output terminal	Transistor output terminal
External power supply	250VAC, below 30VDC	5~24VDC
Circuit insulation	Mechanical insulation of relay	Opto-isolation
Action indication	Light on when relay output contact switch on	Light on when optocoupler is driven
Open loop leakage current	/	< 0.1mA/30VDC
Min. load	MA/5VDC	5MA 5~24VDC
	Max. output current	Resistive load
Inductive load		Y0, Y1 (IVC1H-2416MAT, Y0, Y1, Y2): 7.2W/24VDC; other: 12W/24VDC
Light load		Y0, Y1 (IVC1H-2416MAT, Y0, Y1, Y2): 0.9W/24VDC; other: 1.5W/24VDC
Response time	ON→OFF	Max. 20ms
	OFF→ON	Max. 20ms
Output common terminal	Y0 COM0; Y1 COM1; 1 common terminal is used for every 8 terminals at most after Y2; the common terminals are isolated from each other	

Specifications of analog input module

Project	Specification
Conversion accuracy	12bits
Power supply	Analog circuit
	Digital circuit
Occupied I/O point	Null
Conversion speed	15ms/channel (common speed), 6ms/channel (fastest)
Analog input range	Voltage input
	Current input
Resolution	Voltage input
	Current input
Accuracy	±1%
Isolation	The analog circuit is isolated from the digital circuit by optocoupler, the analog circuit is isolated from the external power supply by DC/DC and the analog channels need no isolation.

Specifications of analog output module

Project		Specification
Conversion accuracy		12bits
Power supply	Analog circuit	24VDC(-15% to 20%), maximum allowable ripple voltage is 5%, input current 120mA I (from the external power supply of the main module)
	Digital circuit	5VDC, 72mA (from the internal power supply of the main unit or active extension module)
Occupied I/O point		Null
Conversion speed		2ms/channel (the channels for change will not change the conversion speed)
Analog output range	Voltage output	-10~10VDC (external load impedance \geq 2k Ω)
	Current output	0~20mA, 4~20mA (external load impedance \leq 520 Ω)
Digital input		Default setting: -2000~2000; allowable range: -10000~10000
Resolution	Voltage output	5mV(10V/2000)
	Current output	10 μ A(20mA/2000)
Accuracy		\pm 1%
Isolation		The analog circuit is isolated from the digital circuit by optocoupler, the analog circuit is isolated from the external power supply by DC/DC and the analog channels need no isolation.

Specifications of thermal resistor module

Project		Specification			
		Celsius ($^{\circ}$ C)		Fahrenheit ($^{\circ}$ F)	
Input channels		2, 4			
Power supply	Analog circuit	24VDC-15%~20%, maximum allowable ripple voltage 5%, 55mA (from the external power supply of the main unit or external connection)			
	Digital circuit	5VDC, 72mA (from the internal power supply of the main unit or active extension unit)			
Occupied I/O point		Null			
Input signal		Type of thermal resistor: Pt100, Cu100, Cu50			
Conversion speed		(15 \pm 2%)ms x used channels (no conversion for the unused channels)			
Rated temperature range		Pt100	-150 $^{\circ}$ C ~+600 $^{\circ}$ C	Pt100	-238 $^{\circ}$ F ~+1112 $^{\circ}$ F
		Cu100	-30 $^{\circ}$ C ~+120 $^{\circ}$ C	Cu100	-22 $^{\circ}$ F ~+248 $^{\circ}$ F
		Cu50	-30 $^{\circ}$ C ~+120 $^{\circ}$ C	Cu50	-22 $^{\circ}$ F ~+248 $^{\circ}$ F
Digital output		12-bit A/D conversion, the temperature is stored through 16-bit binary complement			
		Pt100	-1500 $^{\circ}$ C ~+6000 $^{\circ}$ C	Pt100	-2380 ~+11120
		Cu100	-300 $^{\circ}$ C ~+1200 $^{\circ}$ C	Cu100	-220 ~+2480
		Cu50	-300 $^{\circ}$ C ~+1200 $^{\circ}$ C	Cu50	-220 ~+2480
Min. resolution		Pt100	0.2 $^{\circ}$ C	Pt100	0.36 $^{\circ}$ F
		Cu100	0.2 $^{\circ}$ C	Cu100	0.36 $^{\circ}$ F
		Cu50	0.2 $^{\circ}$ C	Cu50	0.36 $^{\circ}$ F
Accuracy		Full scale \pm 1			
Isolation		The analog circuit is isolated from the digital circuit by optocoupler, the analog circuit is isolated from the internal power supply of module input 24VDC and the analog channels need no isolation.			

Electrical features of digital input

Specifications of thermocouple module

Project		Specification					
		Celsius ($^{\circ}$ C)		Fahrenheit ($^{\circ}$ F)			
Input channels		2, 4					
Power supply	Analog circuit	24VDC-15%~20%, maximum allowable ripple voltage 5%, 50mA (from the external power supply of the main unit or external connection)					
	Digital circuit	5VDC, 72mA (from the internal power supply of the main unit or active extension unit)					
Occupied I/O point		Null					
Input signal		Type of thermal couple: K, J, E, N, T, R, S					
Conversion speed		(240 \pm 2%)ms x used channels (no conversion for the unused channels)					
Rated temperature range		Type K	-100 $^{\circ}$ C ~+1200 $^{\circ}$ C	Type K	-148 $^{\circ}$ F ~+2192 $^{\circ}$ F		
		Type J	-100 $^{\circ}$ C ~+1000 $^{\circ}$ C	Type J	-148 $^{\circ}$ F ~+1832 $^{\circ}$ F		
		Type E	-100 $^{\circ}$ C ~+1000 $^{\circ}$ C	Type E	-148 $^{\circ}$ F ~+1832 $^{\circ}$ F		
		Type N	-100 $^{\circ}$ C ~+1200 $^{\circ}$ C	Type N	-148 $^{\circ}$ F ~+2192 $^{\circ}$ F		
		Type T	-200 $^{\circ}$ C ~+400 $^{\circ}$ C	Type T	-328 $^{\circ}$ F ~+752 $^{\circ}$ F		
		Type R	0 $^{\circ}$ C ~1600 $^{\circ}$ C	Type R	32 $^{\circ}$ F ~2912 $^{\circ}$ F		
		Type S	0 $^{\circ}$ C ~1600 $^{\circ}$ C	Type S	32 $^{\circ}$ F ~2912 $^{\circ}$ F		
Digital output		12-bit A/D conversion, the temperature is stored through 16-bit binary complement					
		Type K	-1000 ~+12000	Type K	-1480 ~+21920		
		Type J	-1000 ~+10000	Type J	-1480 ~+18320		
		Type E	-1000 ~+10000	Type E	-1480 ~+18320		
		Type N	-1000 ~+12000	Type N	-1480 ~+21920		
		Type T	-2000 ~+4000	Type T	-3280 ~+7520		
		Type R	0 ~16000	Type R	320 ~29120		
		Type S	0 ~16000	Type S	320 ~29120		
		Min. resolution		Type K	0.3 $^{\circ}$ C	Type K	0.54 $^{\circ}$ F
				Type J	0.2 $^{\circ}$ C	Type J	0.36 $^{\circ}$ F
Type E	0.3 $^{\circ}$ C			Type E	0.54 $^{\circ}$ F		
Type N	0.3 $^{\circ}$ C			Type N	0.54 $^{\circ}$ F		
Type T	0.2 $^{\circ}$ C			Type T	0.36 $^{\circ}$ F		
Accuracy		Type R	0.5 $^{\circ}$ C	Type R	0.9 $^{\circ}$ F		
		Type S	0.5 $^{\circ}$ C	Type S	0.9 $^{\circ}$ F		
		Full scale \pm 0.5%+1 $^{\circ}$ C, water condensation point: 0 $^{\circ}$ C/32 $^{\circ}$ F					
Isolation		The analog circuit is isolated from the digital circuit by optocoupler, the analog circuit is isolated from the internal power supply of module input 24VDC and the analog channels need no isolation.					

Programming software

- Structured programming, good readability
- Support multiple programming languages
- Support the import and export of subprograms and global variables
- Support online debugging
- Occupy less system resources, fast response

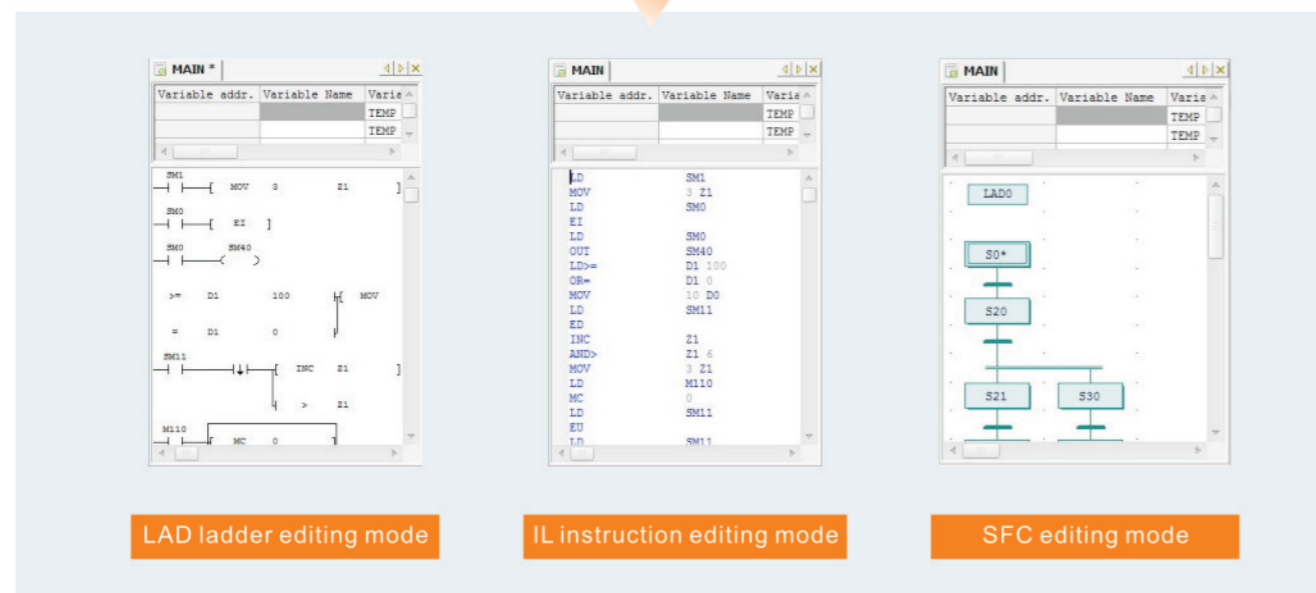
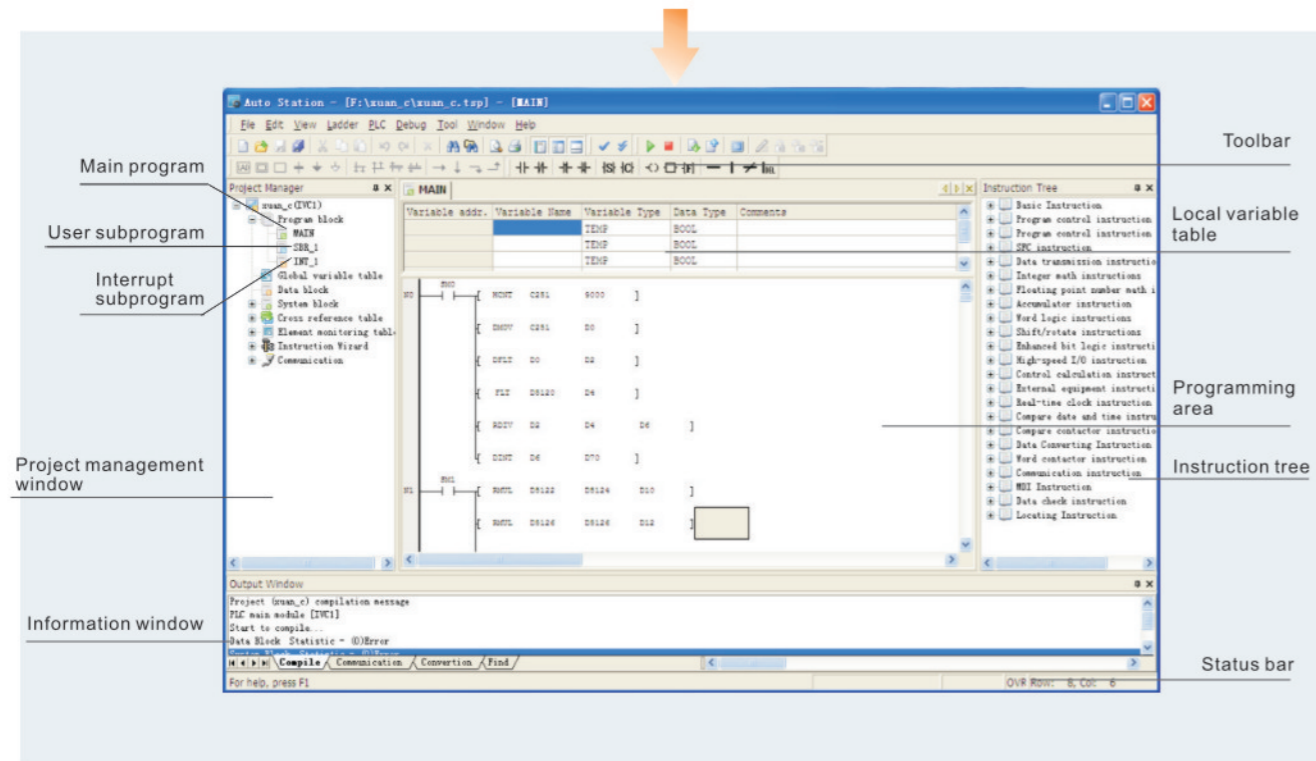

Programming software

Special function configuration

- Provide special function configuration window in system block for programming instructions without references and complex settings.

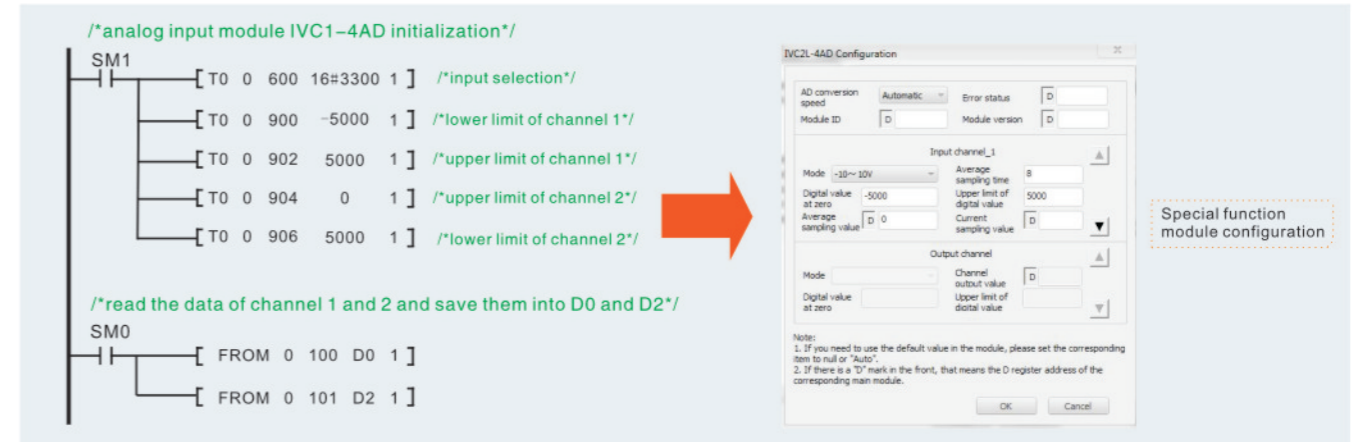

Convenient communication instruction

- No need of complex program and access the communication control instruction to the inverter with one instruction.

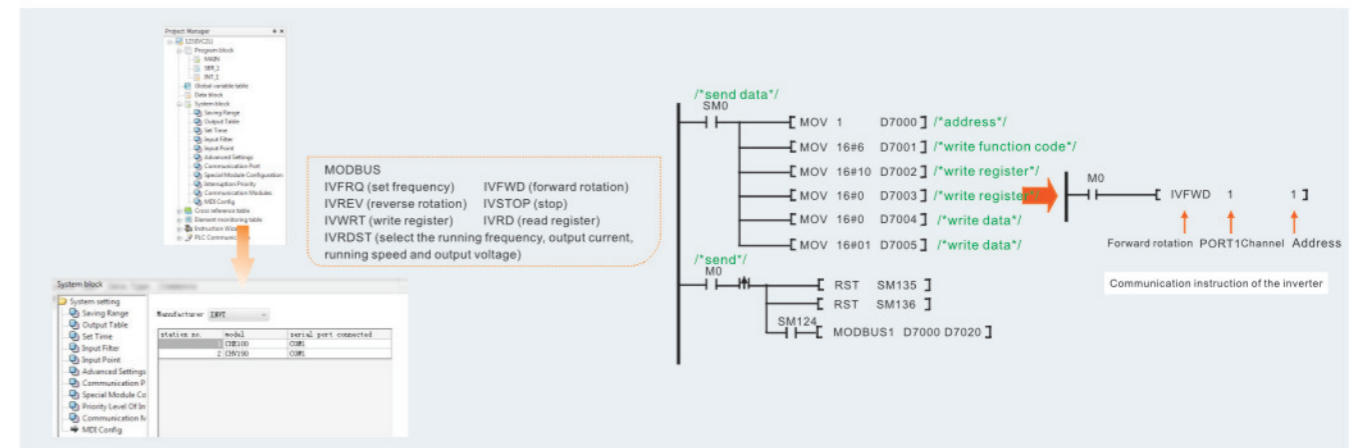

Command wizard

- Use the comand wizard to complete the preparation of complex instructions.

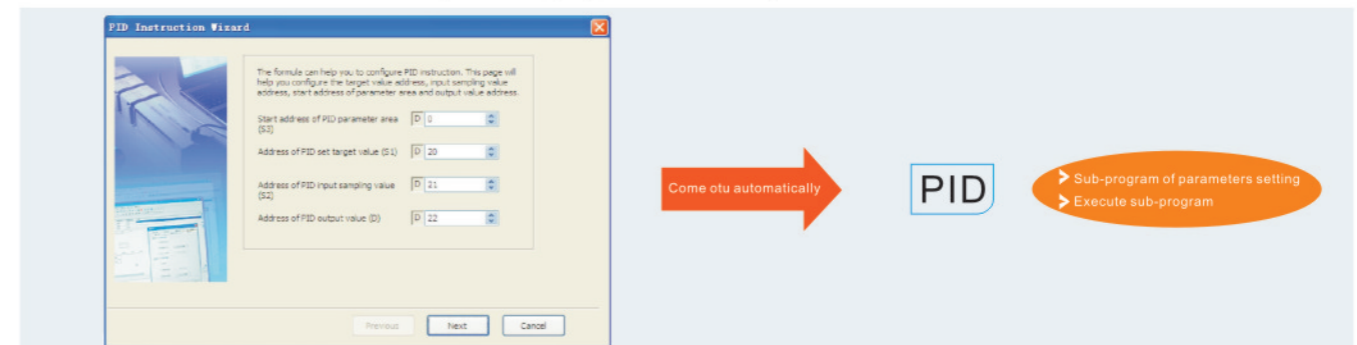

ITC intelligent temperature controller

- ☑ Rich inputs and outputs
- ☑ Excellent EMI/EMC performance
- ☑ High accuracy, intelligence
- ☑ Simple debugging, easy to use
- ☑ Easy and quick data communication
- ☑ Compact structure, easy to install and maintain

Rich inputs and outputs

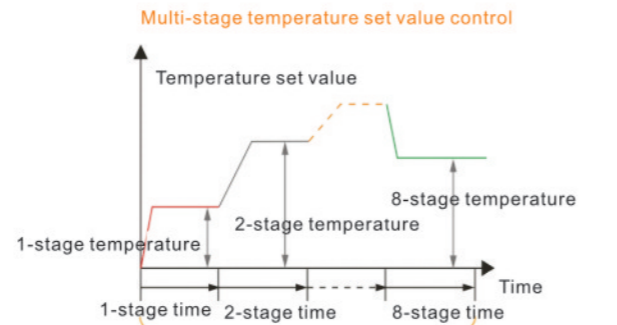
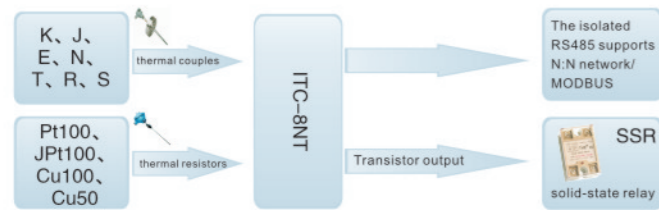

8 stages at most, the temperature and execution time can be set at each stage

Setting the heating curve once avoids setting many times

Improve anti-interference capability

Digital filtering

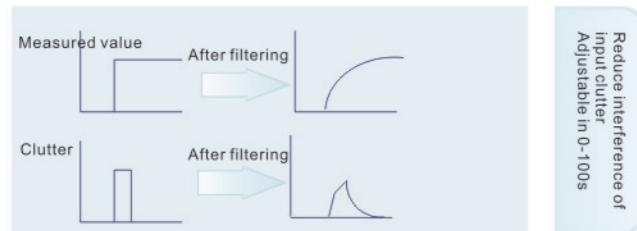

Isolation measures

- Isolate sampling channel from power supply
 - Isolate sampling channel from output
 - Isolate communication port
- Improve anti-interference capability

High accuracy, intelligence

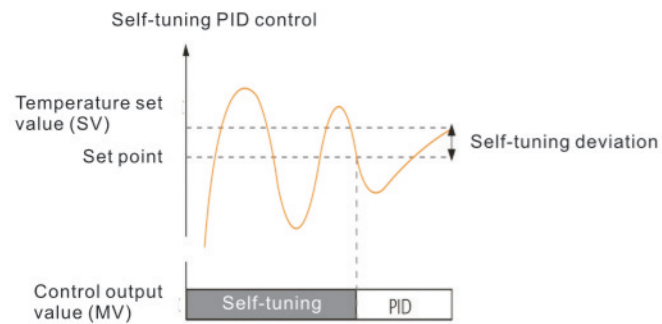

Autotuning, adaptation, automatic generation of PID parameters; intelligent temperature control

Project	Specification
Power supply	24VDC (-15~20%), maximum allowable ripple voltage 5%, Max. power consumption: 90mA (ITC-4NT, 120MA (ITC-8NT))
Input signal	Thermal couple: K, J, E, N, T, R, S (apply to every channel) Thermal resistor: Pt100, JPt100, Cu10, Cu50 (apply to every channel)
Output signal	Transistor output of gate open loop: Circuit power voltage: 5V~24V; Max. circuit power voltage: 30V; Circuit current: 0.3A/24VDC; Open loop leakage current: <0.1Ma/30VDC; Min. load: 5Ma(5VDC~24VDC)
Sampling cycle	Max. execution time for 8 channels is 500ms (no conversion for the unused channels);each time a group of corresponding channels is closed (1&5, 2&6, 3&7, 4&8), the cycle time reduces 125ms.
Control cycle	1~100s, 30s by default
Control method	ON/OFF control, PI control, PID control
Accuracy	±0.7% input range ±1bit
Isolation	The sampling channel is isolated from power supply, the sampling channel is isolated from output and the channels need no isolation.

ITC intelligent temperature controller

Type designation

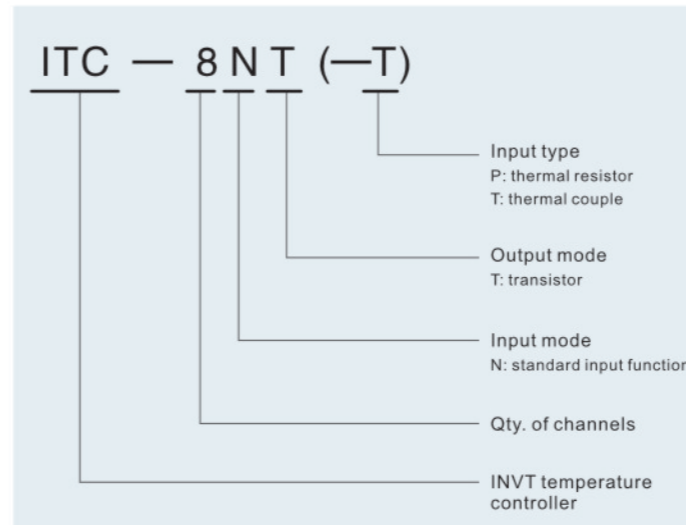

Installation dimension

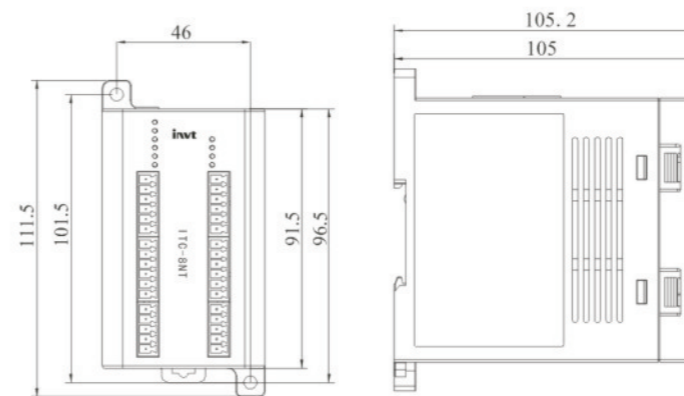

Easy and quick data communication

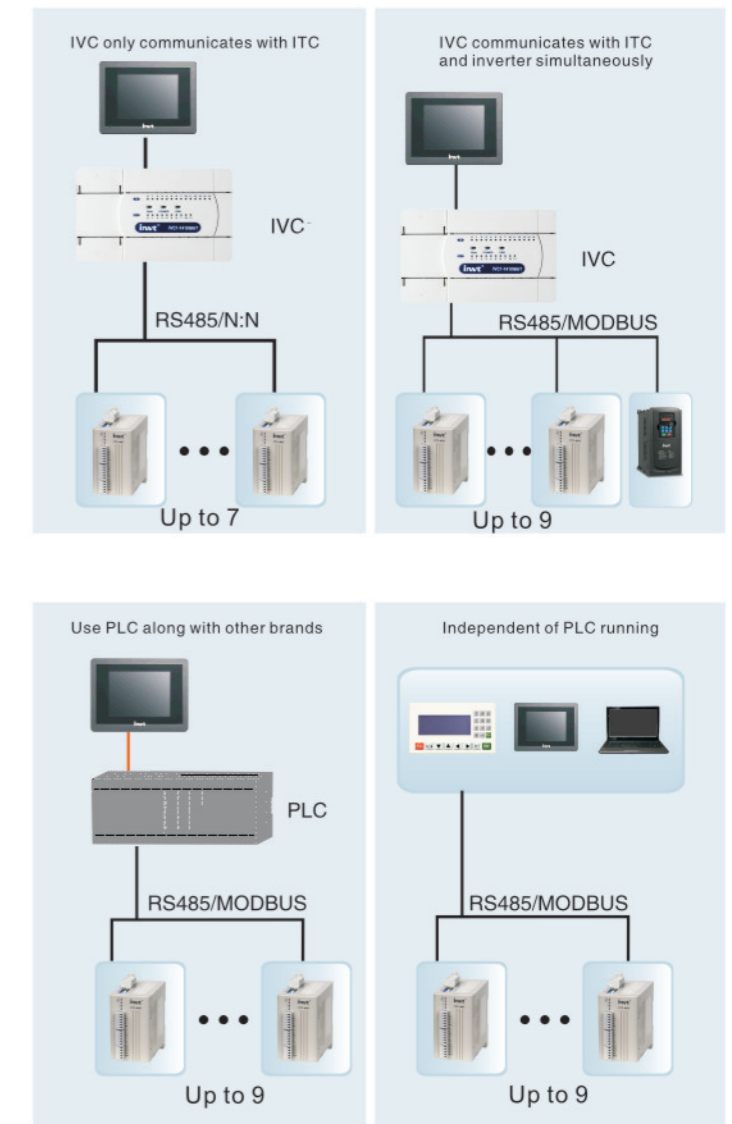
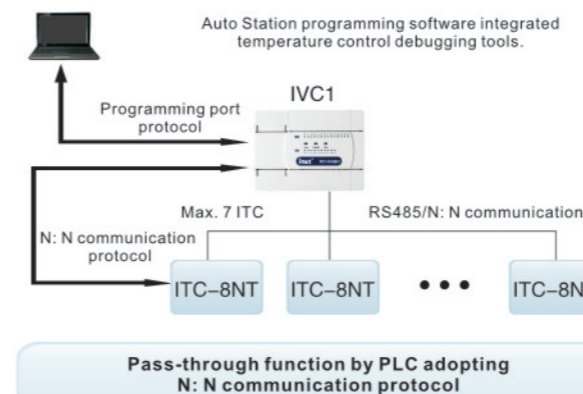

Human-machine interface (HMI)

VT series HMI is easy for the human-machine interface in industry automation with the advantages of various displaying modes, high capacity, flexible configuration and simple operation.

- > Various picture controls
- > Multiple language displaying
- > Support multiple communication connections and sub-connection
- > Support up to 16 data formula
- > A variety of file operations, and easy access to data application



10.4"
800X600 pixel

VT104-H1ET-N
VT104-N1CT-N



7"
800X480 pixel

VT070-H1ET-N
VT070-N0CX-N



5.6"
320X234 pixel

VT056-H0CT-N
VT056-N0CX-N



4.3"
480X272 pixel

VK043-N0CXR

Specifications and technical parameters of VT series HMI

Specifications and technical parameters

Project	VT104-H1ET-N	VT104-N1CT-N	VT070-H1ET-N VT070-H1ET-W	VT070-N0CX-N VT070-N0CX-W	VT056-H0CT-N VT056-H0CT-W	VT056-N0CX-N VT056-N0CX-W	VK043-N0CXR	
Display	Screen size	10.4"	7"	5.6"	4.3"			
	Resolution	800×600	800×480	320×234	480×272			
	Display screen	TFT						
	Color	65536 color						
	Backlight life	20000 hours						
	Luminance	400cd/m ²	300cd/m ²	200cd/m ²	250cd/m ²			
	Touch screen	4-wire resistive touch screen						
	Backlight module	LED						
Hardware resources	CPU	32-bit RISC SOC integrated graphics accelerator						
	Processing speed	200 MHZ						
	Memory	64M	64M	32M				
	Battery backup memory	128KB (optional 1MB)	128KB (optional 1MB)	128KB (optional 1MB)	128KB			
Interface	Flash program memory	8M + 128MB NAND Flash	8M + 128MB NAND Flash	8M	8M			
	Ethernet port	1 x 10/100Mb	None	1 x 10/100Mb	None	None		
	USB interface	1 host, 1 client						
	Print interface	None						
Power supply	Serial interface	com1:RS232/422/485 com2:RS232/485 com3:RS232		com1:RS232/422/485 com2:RS232/485 com3:RS232		com1:RS232/422/485 com3:RS232		
	Micro SD card slot	Y		N				
	Input power	24VDC±10%						
Environment	Power consumption	20W	15W	13W				
	Operating temperature	0°C ~ 50°C						
	Storage temperature	-20°C ~ 60°C						
	Relative humidity	10%~90%RH (no condensation)						
	Storage humidity	10%~90%RH (no condensation)						
	Ingress protection	Conform to NEMA4/IP65 (front panel)						
Structure	Safety certification	CE/FCC						
	Cooling	Natural cooling						
	Outlet dimension (W*H: mm)	270.1X212.1	N type: 188×143.3 W type: 203.5×148.5	N type: 188×143.3 W type: 203.5×148.5	130.0X106.2			
	Cut out dimension (W*H: mm)	259.0x201.0	N type: 174.5×132.5 W type: 191.0×137.5	N type: 174.5×132.5 W type: 191.0×137.5	119.0X93.0			
	Cut out depth (mm)	42.5	40	40	40			
	Depth of front panel (mm)	6	6	6	6			
	Net weight	1.2 Kg	0.6 Kg	0.59 Kg	0.35 Kg			

Naming rule

Main module and I/O extension module

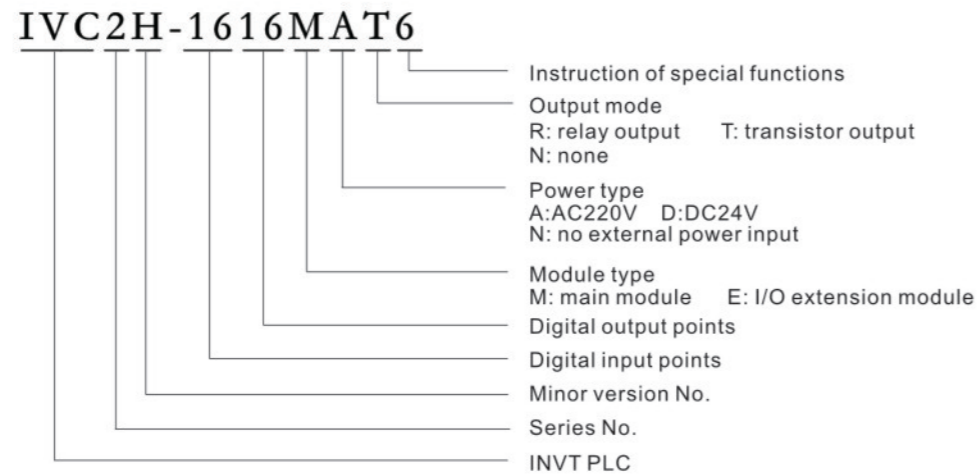

Special function module

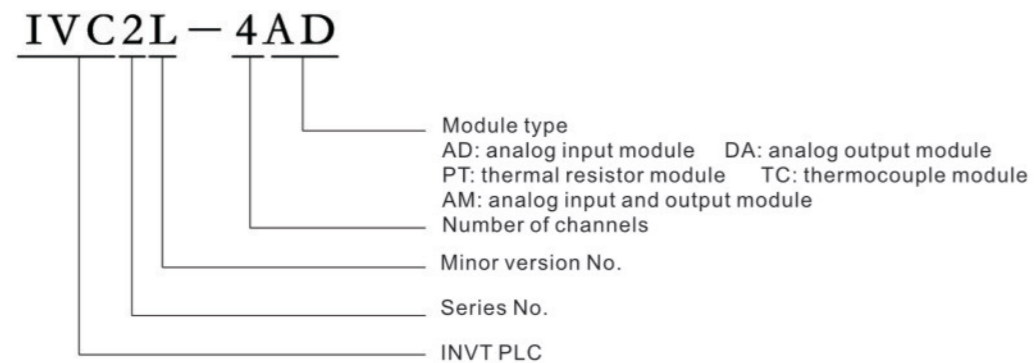

Human-machine interface HMI

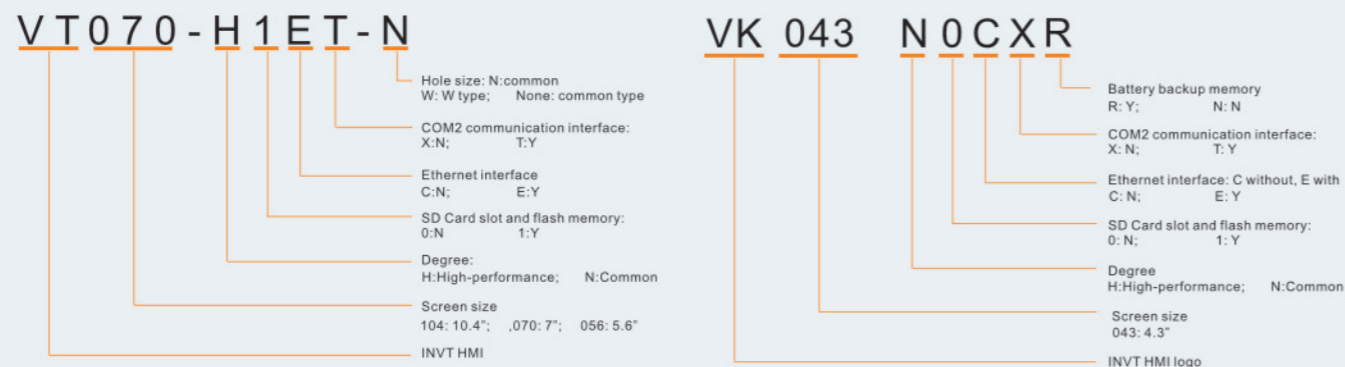

Product selection

IVC1 main module

Project	Specification	Dimension (L × W × H, mm)
IVC1-1006MAR	10-point DC24V input, 6-point relay output, AC220V power supply	135 × 90 × 71.2
IVC1-1006MAT	10-point DC24V input, 6-point transistor output, AC220V power supply	135 × 90 × 71.2
IVC1-1410MAR	14-point DC24V input, 10-point relay output, AC220V power supply	135 × 90 × 71.2
IVC1-1410MAT	14-point DC24V input, 10-point transistor output, AC220V power supply	135 × 90 × 71.2
IVC1-1614MAR	16-point DC24V input, 14-point relay output, AC220V power supply	150 × 90 × 71.2
IVC1-1614MAT	16-point DC24V input, 14-point transistor output, AC220V power supply	150 × 90 × 71.2
IVC1-2416MAR	24-point DC24V input, 16-point relay output, AC220V power supply	182 × 90 × 71.2
IVC1-2416MAT	24-point DC24V input, 16-point transistor output, AC220V power supply	182 × 90 × 71.2
IVC1-3624MAR	36-point DC24V input, 24-point relay output, AC220V power supply	224.5 × 90 × 71.2
IVC1-3624MAT	36-point DC24V input, 24-point transistor output, AC220V power supply	224.5 × 90 × 71.2
IVC1-0808MAR1	8-point DC24V input, 8-point relay output, integrated 6 analog inputs (4 channels can be optional for μ A signals) and 1 analog output, AC220V power supply	182 × 90 × 71.2
IVC1-0808MAT1	8-point DC24V input, 8-point transistor output, integrated 6 analog inputs (4 channels can be optional for μ A signals) and 1 analog output, AC220V power supply	182 × 90 × 71.2
IVC1-1614MAR1	16-point DC24V input, 14-point relay output, integrated 2 analog inputs and 1 analog output, AC220V power supply	182 × 90 × 71.2
IVC1-1614MAT1	16-point DC24V input, 14-point transistor output, integrated 2 analog inputs and 1 analog output, AC220V power supply	182 × 90 × 71.2
IVC1-1006MDR	10-point DC24V input, 6-point relay output, DC24V power supply	135 × 90 × 71.2
IVC1-1006MDT	10-point DC24V input, 6-point transistor output, DC24V power supply	135 × 90 × 71.2
IVC1-1410MDR	14-point DC24V input, 10-point relay output, DC24V power supply	135 × 90 × 71.2
IVC1-1410MDT	14-point DC24V input, 10-point transistor output, DC24V power supply	135 × 90 × 71.2
IVC1-1614MDR	16-point DC24V input, 14-point relay output, DC24V power supply	150 × 90 × 71.2
IVC1-1614MDT	16-point DC24V input, 14-point transistor output, DC24V power supply	150 × 90 × 71.2
IVC1-2416MDR	24-point DC24V input, 16-point relay output, DC24V power supply	182 × 90 × 71.2
IVC1-2416MDT	24-point DC24V input, 16-point transistor output, DC24V power supply	182 × 90 × 71.2
IVC1-3624MDR	36-point DC24V input, 24-point relay output, DC24V power supply	224.5 × 90 × 71.2
IVC1-3624MDT	36-point DC24V input, 24-point transistor output, DC24V power supply	224.5 × 90 × 71.2

Project	Specification	Dimension (L x W x H, mm)
IVC1-0808MDR1	8-point DC24V input, 8-point relay output, integrated 6 analog inputs (4 channels can be optional for μ A signals) and 1 analog output, DC24V power supply	182 x 90 x 71.2
IVC1-0808MDT1	8-point DC24V input, 8-point transistor output, integrated 6 analog inputs (4 channels can be optional for μ A signals) and 1 analog output, DC24V power supply	182 x 90 x 71.2
IVC1-1614MDR1	16-point DC24V input, 14-point relay output, integrated 2 analog inputs and 1 analog output, DC24V power supply	182 x 90 x 71.2
IVC1-1614MDT1	16-point DC24V input, 14-point transistor output, integrated 2 analog inputs and 1 analog output, DC24V power supply	182 x 90 x 71.2

IVC1 main module (Removable screw terminals)

Project	Specification	Dimension (L x W x H, mm)
IVC1-1006MAR2	10-point DC24V input, 6-point relay output, AC220V power supply	135 x 90 x 79.2
IVC1-1006MAT2	10-point DC24V input, 6-point transistor output, AC220V power supply	135 x 90 x 79.2
IVC1-1410MAR2	14-point DC24V input, 10-point relay output, AC220V power supply	135 x 90 x 79.2
IVC1-1410MAT2	14-point DC24V input, 10-point transistor output, AC220V power supply	135 x 90 x 79.2
IVC1-1614MAR2	16-point DC24V input, 14-point relay output, AC220V power supply	150 x 90 x 79.2
IVC1-1614MAT2	16-point DC24V input, 14-point transistor output, AC220V power supply	150 x 90 x 79.2
IVC1-2416MAR2	24-point DC24V input, 16-point relay output, AC220V power supply	182 x 90 x 79.2
IVC1-2416MAT2	24-point DC24V input, 16-point transistor output, AC220V power supply	182 x 90 x 79.2
IVC1-3624MAR2	36-point DC24V input, 24-point relay output, AC220V power supply	224.5 x 90 x 79.2
IVC1-3624MAT2	36-point DC24V input, 24-point transistor output, AC220V power supply	224.5 x 90 x 79.2
IVC1-0808MAR6	8-point DC24V input, 8-point relay output, integrated 6 analog inputs (4 channels can be optional for μ A signals) and 1 analog output, AC220V power supply	182 x 90 x 79.2
IVC1-0808MAT6	8-point DC24V input, 8-point transistor output, integrated 6 analog inputs (4 channels can be optional for μ A signals) and 1 analog output, AC220V power supply	182 x 90 x 79.2
IVC1-1614MAR6	16-point DC24V input, 14-point relay output, integrated 2 analog inputs and 1 analog output, AC220V power supply	182 x 90 x 79.2
IVC1-1614MAT6	16-point DC24V input, 14-point transistor output, integrated 2 analog inputs and 1 analog output, AC220V power supply	182 x 90 x 79.2
IVC1-1006MDR2	10-point DC24V input, 6-point relay output, DC24V power supply	135 x 90 x 79.2
IVC1-1006MDT2	10-point DC24V input, 6-point transistor output, DC24V power supply	135 x 90 x 79.2
IVC1-1410MDR2	14-point DC24V input, 10-point relay output, DC24V power supply	135 x 90 x 79.2
IVC1-1410MDT2	14-point DC24V input, 10-point transistor output, DC24V power supply	135 x 90 x 79.2
IVC1-1614MDR2	16-point DC24V input, 14-point relay output, DC24V power supply	150 x 90 x 79.2

Project	Specification	Dimension (L x W x H, mm)
IVC1-1614MDT2	16-point DC24V input, 14-point transistor output, DC24V power supply	150 x 90 x 79.2
IVC1-2416MDR2	24-point DC24V input, 16-point relay output, DC24V power supply	182 x 90 x 79.2
IVC1-2416MDT2	24-point DC24V input, 16-point transistor output, DC24V power supply	182 x 90 x 79.2
IVC1-3624MDR2	36-point DC24V input, 24-point relay output, DC24V power supply	224.5 x 90 x 79.2
IVC1-3624MDT2	36-point DC24V input, 24-point transistor output, DC24V power supply	224.5 x 90 x 79.2
IVC1-0808MDR6	8-point DC24V input, 8-point relay output, integrated 6 analog inputs (4 channels can be optional for μ A signals) and 1 analog output, DC24V power supply	182 x 90 x 79.2
IVC1-0808MDT6	8-point DC24V input, 8-point transistor output, integrated 6 analog inputs (4 channels can be optional for μ A signals) and 1 analog output, DC24V power supply	182 x 90 x 79.2
IVC1-1614MDR6	16-point DC24V input, 14-point relay output, integrated 2 analog inputs and 1 analog output, DC24V power supply	182 x 90 x 79.2
IVC1-1614MDT6	16-point DC24V input, 14-point transistor output, integrated 2 analog inputs and 1 analog output, DC24V power supply	182 x 90 x 79.2

I/O extension module

Project	Specification	Dimension (L x W x H, mm)
IVC1-0808ENR	8-point DC24V input, 8-point relay output	61 x 90 x 71.2
IVC1-0808ENT	8-point DC24V input, 8-point transistor output	
IVC1-1600ENN	16-point DC24V input	
IVC1-0016ENR	16-point relay output	
IVC1-0016ENT	16-point transistor output	

Special function module

Project	Specification	Dimension (L x W x H, mm)
IVC1-2AD、IVC1-4AD	2/4 analog inputs	61 x 90 x 71.2
IVC1-2DA、IVC1-4DA	2/4 analog outputs	
IVC1-5AM	4 analog inputs and 1 analog output	
IVC1-2PT、IVC1-4PT	2/4 thermal resistors	
IVC1-2TC、IVC1-4TC	2/4 thermocouples	

Product selection

IVC2L main module(Removable screw terminals)

Project	Specification	Dimension (L × W × H, mm)
IVC2L-2012MAR	20-point DC24V input, 12-point relay output, AC220V power supply	158 × 90 × 82
IVC2L-2012MAT	20-point DC24V input, 12-point transistor output, AC220V power supply	158 × 90 × 82
IVC2L-3232MAR	32-point DC24V input, 32-point relay output, AC220V power supply	228 × 90 × 82
IVC2L-3232MAT	32-point DC24V input, 32-point transistor output, AC220V power supply	228 × 90 × 82

IVC2H main module(Removable screw terminals)

Project	Specification	Dimension (L × W × H, mm)
IVC2H-1616MAT4	16-point DC24V input, 16-point transistor output, 4-axis positioning, AC220V power supply	170 × 90 × 82
IVC2H-1616MAT6	16-point DC24V input, 16-point transistor output, 6-axis positioning, AC220V power supply	

I/O extension module

Project	Specification	Dimension (L × W × H, mm)
IVC2L-0808ENR	8-point DC24V input, 8-point relay output	58 × 90 × 82
IVC2L-0808ENT	8-point DC24V input, 8-point transistor output	
IVC2L-1600ENN	16-point DC24V input	
IVC2L-0016ENR	16-point relay output	
IVC2L-0016ENT	16-point transistor output	158 × 90 × 82
IVC2L-1616EAR	16-point DC24V input, 16-point relay output, AC220V power supply	

Special function module

Project	Specification	Dimension (L × W × H, mm)
IVC2L-4AD、IVC2L-8AD	4/8 analog inputs	58 × 90 × 82
IVC2L-4DA	4 analog outputs	
IVC2L-4PT	4 thermal resistors	
IVC2L-4TC	4 thermocouples	

Communication module and communication adapter

Project	Specification	Dimension (L × W × H, mm)
IVCS-EPM	Serial port to Ethernet adapter	56×82×26
IVC2L-RS485	RS485 extension module (isolated)	32×90×82
IVC2L-COPM	CANopen master module	58×90×82
IVC2L-GPRS	GPRS module	58×90×82

Temperature controller

Project	Specification	Dimension (L × W × H, mm)
ITC-4NT (-T)	4 temperature controllers (thermocouple)	46 × 111.5 × 105
ITC-4NT (-P)	4 temperature controllers (thermal resistor)	
ITC-8NT (-T)	8 temperature controllers (thermocouple)	
ITC-8NT (-P)	8 temperature controllers (thermal resistor)	

VT series HMI

Project	Specification	Dimension (W × H, mm)
VT104-H1ET-N	10.4", TFT color touch panel, 65536 colors; memory:8MB+128MB; RTC; Ethernet port, COM1:RS422/232/485, COM2: RS232/485, COM3: RS232; Micro SD card slot, 800x600	259.0×201.0
VT104-N1CT-N	10.4", TFT color touch panel, 65536 colors; memory:8MB+128MB; RTC; COM1:RS422/232/485, COM2: RS232/485, COM3: RS232; Micro SD card slot, 800x600	259.0×201.0
VT070-H1ET-N	7", TFT color touch panel, 65536 colors; memory:8MB+128MB; RTC; Ethernet port, COM1:RS422/232/485, COM2: RS232/485, COM3: RS232; Micro SD card slot, 800x480	174.5×132.5
VT070-N0CX-N	7", TFT color touch panel, 65536 colors; memory:8MB; RTC; COM1:RS422/232/485, COM3: RS232; 800x480	174.5×132.5
VT056-H0CT-N	5.6", TFT color touch panel, 65536 colors; memory:8MB; RTC; COM1:RS422/232/485, COM2: RS232/485, COM3: RS232; 320x234	174.5×132.5
VT056-N0CX-N	5.6", TFT color touch panel, 65536 colors; memory:8MB; RTC; COM1:RS422/232/485, COM3: RS232; 320x234	174.5×132.5
VK043-N0CX-N	4.3", TFT color touch panel, 65536 colors; memory:8MB; RTC; COM1:RS422/232/485, COM3: RS232; 480x272	119.0×93.0

Cable

Project	Specification	Cable length
IVC-SL1	Serial port download cable (PLC)	3m
IVC-SL2	USB download cable (PLC)	2m
IVC-SL3	PLC-VT connecting cable	3m
IVC-SL4	USB download cable (HMI)	1.5m
IVC-SL5	PLC-VT connecting cable	7m