

Goodrive27 Series Smart VFD

User Guide



Preface

Overview

Thank you for purchasing INVT Goodrive27 series variable-frequency drive (VFD). If not otherwise specified, the VFD mentioned in this manual refers to Goodrive27 series VFD. The product is widely used in industries such as woodworking, textiles, food, printing bags, plastics, logistics and transportation equipment.

This manual mainly describes the methods of mechanical installation, electrical installation, operation methods, commissioning, maintenance and troubleshooting of the VFD. Read the manual carefully before installing and using the VFD.

Readers

Personnel with electrical professional knowledge (such as qualified electrical engineers or personnel with equivalent knowledge).

Change history

The manual is subject to change irregularly without prior notice due to product version upgrades or other reasons.

No.	Change description	Version	Release date
1	First release.	V1.0	May 2023
2	<ul style="list-style-type: none"> ● Added the Y1 output wiring to Figure 4-9 Control circuit wiring diagram. ● Updated the active input high level range and active input low level range from 10–30V and 0–5V to 16–30V and 0–2V in section 4.5.2 Control circuit terminals. ● Updated SIL to SIL2 and deleted PL related safety content from section E.1 Safety standards. ● Corrected minor errors. 	V1.1	September 2023

Contents

1 Safety precautions	1
1.1 Safety declaration	1
1.2 Safety level definition.....	1
1.3 Personnel requirements.....	1
1.4 Safety guidelines	2
2 Product overview	5
2.1 Product nameplate and model.....	5
2.2 Product specifications.....	5
2.3 Product ratings	7
2.4 Product heat dissipation	8
2.5 Product dimensions and weight.....	9
2.6 Product structure	10
2.7 System configuration	11
2.8 Quick startup	14
3 Mechanical installation	15
3.1 Unpacking inspection.....	15
3.2 Preparing.....	15
3.2.1 Installation environment and site.....	16
3.2.2 Installation direction	17
3.2.3 Installation space	18
3.3 Installation and uninstallation	19
3.3.1 Installation	20
3.3.2 Dismounting	22
4 Electrical installation	24
4.1 Insulation inspection.....	24
4.2 Checking compatible grounding systems	24
4.3 Cable selection and routing	26
4.3.1 Cable selection	26
4.3.2 Cable arrangement	28
4.4 Main circuit wiring	29
4.4.1 Main circuit wiring.....	29
4.4.2 Main circuit terminals	29
4.4.3 Wiring procedure.....	30
4.5 Control circuit wiring.....	32
4.5.1 Control circuit wiring	32
4.5.2 Control circuit terminals.....	33
4.5.3 Input/output signal wiring.....	34
4.6 Power distribution protection	36

5 Keypad operation guidelines	38
5.1 Keypad panel display	38
5.1.1 Status indicator	38
5.1.2 Display area	39
5.1.3 Key	40
5.2 Keypad display.....	41
5.2.1 Displaying stopped-state parameters	41
5.2.2 Displaying running-state parameters	41
5.2.3 Fault display	42
5.3 Operation procedure.....	42
5.3.1 Modifying function parameters.....	42
5.3.2 Setting a password for the VFD	43
5.3.3 Viewing function parameters	44
6 Commissioning	45
6.1 Motor parameter setting	46
6.1.1 Motor type selection	46
6.1.2 Rated motor parameter setting	46
6.2 Motor parameter autotuning setting.....	47
6.3 Running command selection	48
6.4 Frequency setting.....	52
6.4.1 Combination of frequency setting source	53
6.4.2 Frequency setting method	54
6.4.3 Frequency fine-tuning	68
6.5 Speed control mode selection	69
6.6 Torque setting method	70
6.6.1 Torque setting method selection.....	70
6.6.2 Switching between speed control and torque control.....	71
6.7 Start/stop settings.....	72
6.7.1 Start settings	72
6.7.2 Stop settings.....	74
6.7.3 Power-off restart	78
6.8 Control performance regulation.....	80
6.8.1 Space vector control performance optimization	80
6.8.2 Vector control performance optimization.....	86
6.9 Input and output.....	93
6.9.1 Digital input and output	93
6.9.2 Analog input and output terminal functions.....	105
6.10 RS485 communication	111
6.11 Monitoring parameters	114
Group P07—Human-machine interface (HMI)	115

Group P17—Status viewing.....	118
6.12 Protection parameter setting	123
6.12.1 Overvoltage stalling protection	123
6.12.2 Current-limit protection	125
6.12.3 Frequency decrease at sudden power failure	126
6.12.4 Cooling fan control	128
6.12.5 Dynamic braking	129
6.12.6 Safe torque off.....	129
6.13 Typical applications	130
6.13.1 Counting	130
6.13.2 Sleep and wakeup.....	131
6.13.3 Switchover between FWD run and REV run	133
6.13.4 Jump frequency	135
6.13.5 Wobbling frequency.....	136
7 Communication	138
7.1 Standard communication interface	138
7.2 Communication data address	138
7.2.1 Function parameter address	138
7.2.2 Non-function parameter address	139
7.3 Modbus networking.....	142
7.3.1 Network topology	143
7.3.2 RTU mode	144
7.3.3 RTU command code	147
7.3.4 Fieldbus scale.....	152
7.3.5 Error message response	153
7.3.6 Communication commissioning.....	154
8 Fault handling	156
8.1 Fault indication and reset	156
8.2 Faults and solutions	156
8.2.1 Common faults and solutions	156
8.2.2 Other status.....	161
8.3 Analysis on common faults	162
8.3.1 Motor fails to work	162
8.3.2 Motor vibrates	163
8.3.3 Overvoltage	164
8.3.4 Undervoltage.....	165
8.3.5 Overcurrent	166
8.3.6 Motor overheating	167
8.3.7 VFD overheating	168
8.3.8 Motor stalls during ACC	169

8.4 Countermeasures on common interference	169
8.4.1 Interference problems of meter switch and sensors	169
8.4.2 Interference on RS485 communication	171
8.4.3 Failure to stop and indicator shimmering due to motor cable coupling.....	172
8.4.4 Leakage current and interference on RCD.....	172
8.4.5 Live device housing.....	174
9 Inspection and maintenance	175
9.1 Daily inspection and regular maintenance	175
9.2 Cooling fan replacement.....	176
9.3 Reforming.....	178
Appendix A Technical data	180
A.1 Derating due to temperature.....	180
A.2 Derating due to altitude	181
A.3 Derating due to carrier frequency	181
A.4 Grid specifications	182
A.5 Motor connection data.....	182
A.5.1 Motor cable length for normal operation.....	182
A.5.2 Motor cable length for EMC	183
Appendix B Application standards	184
B.1 List of application standards	184
B.2 CE/TUV/UL/CCS certification	184
B.3 EMC compliance declaration	185
B.4 EMC product standard	185
Appendix C Dimension drawings	186
C.1 VFD overall dimensions.....	186
Appendix D Peripheral accessories	188
D.1 Cable	188
D.1.1 Power cable	188
D.1.2 Control cable.....	193
D.2 Breaker and electromagnetic contactor.....	193
D.3 Optional parts	194
D.3.1 Reactor	194
D.3.2 Filter	195
D.3.3 Braking component.....	196
D.3.4 Mounting bracket	198
Appendix E STO function	201
E.1 Safety standards.....	201
E.2 Safety function description.....	202
E.3 Risk assessment.....	203
E.4 STO wiring.....	203

E.5 STO function terminal description	205
E.6 STO function logic table	205
E.7 STO channel delay description	205
E.8 Acceptance test	206
Appendix F Function parameter list	209
Group P00—Basic functions.....	209
Group P01—Start and stop control	213
Group P02—Parameters of motor 1	218
Group P03—Vector control of motor 1	222
Group P04—V/F control.....	229
Group P05—Input terminal functions	233
Group P06—Output terminal functions	239
Group P07—Human-machine interface	243
Group P08—Enhanced functions.....	252
Group P09—PID control	263
Group P10—Simple PLC and multi-step speed control.....	267
Group P11—Protection functions.....	271
Group P13—SM control	277
Group P14—Serial communication	279
Group P17—Status viewing.....	282

1 Safety precautions





1.1 Safety declaration

Read this manual carefully and follow all safety precautions before moving, installing, operating and servicing the VFD. Otherwise, equipment damage or physical injury or death may be caused.

We shall not be liable or responsible for any equipment damage or physical injury or death caused due to failure to follow the safety precautions.

1.2 Safety level definition

To ensure personal safety and avoid property damage, you must pay attention to the warning symbols and tips in the manual.





Warning symbols	Name	Description
	Danger	Severe personal injury or even death can result if related requirements are not followed.
	Electric shock	Severe personal injury or even death can result if related requirements are not followed. As high voltage still presents in the bus capacitor after power off, wait for at least 5 minutes (depending on the warning symbols on the machine) after power off to prevent electric shock.
	Warning	Personal injury or equipment damage can result if related requirements are not followed.
	Electrostatic discharge	Equipment damage or internal component damage can result if related requirements are not followed.
	Hot sides	You may get burnt if related requirements are not followed.
Note	Note	Slight personal injury or equipment damage can result if related requirements are not followed.

1.3 Personnel requirements

Trained and qualified professionals: People operating the equipment must have received professional electrical and safety training and obtained the certificates, and must be familiar with all steps and requirements of equipment installing,

commissioning, running and maintaining and capable to prevent any emergencies according to experiences.



1.4 Safety guidelines

General principles									
	<ul style="list-style-type: none"> Only trained and qualified professionals are allowed to carry out related operations. Do not perform wiring, inspection or component replacement when power supply is applied. Before performing these operations, ensure all the input power supplies have been disconnected, and wait for at least the time designated on the VFD. The minimum waiting time is listed in the following. <table border="1" style="margin-left: auto; margin-right: auto;"> <thead> <tr> <th style="background-color: #d9e1f2;">Model</th> <th style="background-color: #d9e1f2;">Minimum waiting time</th> </tr> </thead> <tbody> <tr> <td>1PH 220V 0.4–2.2kW</td> <td>5 minutes</td> </tr> <tr> <td>3PH 220V 0.4–4kW</td> <td>5 minutes</td> </tr> <tr> <td>3PH 380V 0.75–7.5kW</td> <td>5 minutes</td> </tr> </tbody> </table>	Model	Minimum waiting time	1PH 220V 0.4–2.2kW	5 minutes	3PH 220V 0.4–4kW	5 minutes	3PH 380V 0.75–7.5kW	5 minutes
Model	Minimum waiting time								
1PH 220V 0.4–2.2kW	5 minutes								
3PH 220V 0.4–4kW	5 minutes								
3PH 380V 0.75–7.5kW	5 minutes								
	<ul style="list-style-type: none"> Do not modify the VFD unless authorized; otherwise fire, electric shock or other injury may result. The VFD cannot be used as an "emergency-stop device". The VFD cannot act as an emergency brake for the motor; it is a must to install a mechanical braking device. Prevent the screws, cables and other conductive parts from falling into the VFD. 								
	<ul style="list-style-type: none"> The base may become hot when the VFD is running. Do not touch. Otherwise, you may get burnt. 								
	<ul style="list-style-type: none"> The electrical parts and components inside the VFD are electrostatic sensitive. Take measurements to prevent electrostatic discharge when performing related operations. 								

Delivery	
	<ul style="list-style-type: none"> Select appropriate tools for VFD delivery to avoid damage to the VFD, and take protective measures like wearing safety shoes and working uniforms to avoid physical injury or death. Protect the VFD against physical shock or vibration. Do not carry the VFD only by its front cover as the cover may fall off.



Installation	
	<ul style="list-style-type: none"> Do not install the VFD on inflammables. In addition, prevent the VFD from contacting or adhering to inflammables. Do not install the damaged or incomplete VFD.

Installation	
	<ul style="list-style-type: none"> Do not contact the VFD with damp objects or body parts. Otherwise, electric shock may result.
	<ul style="list-style-type: none"> The installation site must be away from children and other public places (See 3.2.1 Installation environment and site for details). Connect the optional braking parts (such as braking resistors, braking units or feedback units) according to the wiring diagrams. As VFD leakage current caused during running may exceed 3.5mA, ground properly and ensure the grounding resistance is less than 10Ω. The conductivity of PE grounding conductor is the same as that of the phase conductor. R, S, and T are the power input terminals, while U, V, and W are the output motor-connection terminals. Connect the input power cables and motor cables properly; otherwise, the VFD may be damaged. When the VFD is installed in a confined space (such as cabinet), it is necessary to provide protective devices (such as fireproof housing, electrical protective housing, mechanical protective housing, etc.) that meet the IP rating, and the IP rating shall comply with the relevant IEC standards and local regulations.

Commissioning	
	<ul style="list-style-type: none"> The VFD may start up by itself when power-off restart is enabled (P01.21=1). Do not get close to the VFD and motor.
	<ul style="list-style-type: none"> Do not switch on or switch off the input power supplies of the VFD frequently. If the VFD has been stored without use for a long time, perform capacitor reforming (described in 9.3 Reforming), inspection and pilot run for the VFD before the reuse.

Running	
	<ul style="list-style-type: none"> Close the VFD front cover before running; otherwise, electric shock may occur. High voltage presents inside the VFD during running. Do not carry out any operation on the VFD during running except for keypad setup. The control terminals of the VFD form extra-low voltage (ELV) circuits. Therefore, you need to prevent the control terminals from connecting to accessible terminals of other devices. During driving a synchronous motor, besides above-mentioned items, the following work must be done: <ul style="list-style-type: none"> ✓ All input power supplies have been disconnected, including the

Running	
	<p>main power and control power.</p> <ul style="list-style-type: none"> ✓ The synchronous motor has been stopped, and the voltage on output end of the VFD is lower than 36V. ✓ After the synchronous motor has stopped, wait for at least the time designated on the VFD. ✓ During operation, it is a must to ensure the synchronous motor cannot run again by the action of external load; it is recommended to install an effective external braking device or cut off the direct electrical connection between the synchronous motor and the VFD.

Maintenance	
	<ul style="list-style-type: none"> ● Do not perform VFD maintenance or component replacement when the power is on. Otherwise, electric shock may result. ● Keep the VFD and its parts and components away from combustible materials and ensure they have no combustible materials adhered.
	<ul style="list-style-type: none"> ● During maintenance and component replacement, take proper anti-static measures on the VFD and its internal parts.
	<ul style="list-style-type: none"> ● Do not carry out insulation voltage-endurance test on the VFD, or measure the control circuits of the VFD with a megohmmeter.
Note	<ul style="list-style-type: none"> ● Use proper torque to tighten screws.

Disposal	
	<ul style="list-style-type: none"> ● The VFD contains heavy metals. Dispose of a scrap VFD as industrial waste.

2 Product overview

2.1 Product nameplate and model

Each VFD is affixed with a nameplate containing the basic product information and, depending on the actual certification, certification marks such as the CE mark.

The product models can be divided into two types:

Standard models (GD27-1R5G-4-B): Neither STO nor EMC filter embedded

EU models (GD27-1R5G-4-B-EU): With embedded STO and EMC C2/C3 filter (C2 applicable to S2 models, while C3 applicable to -2 and -4 models)

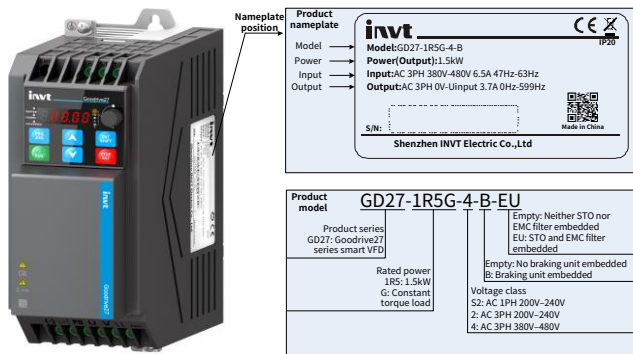

2.2 Product specifications

Item		Specifications
Input	Input voltage (V)	AC 1PH 200V-240V AC 3PH 200V-240V AC 3PH 380V-480V
	Input current (A)	See 2.3 Product ratings.
	Input frequency (Hz)	50Hz or 60Hz; Allowed range: 47-63Hz
Output	Output voltage (V)	0-Input voltage (V)

Item		Specifications
	Output current (A)	See 2.3 Product ratings.
	Output power (kW)	See 2.3 Product ratings.
	Output frequency (Hz)	0–599Hz
Control performance	Control mode	Space voltage vector control, and sensorless vector control (SVC)
	Motor	Motor type: Asynchronous motor (AM) and synchronous motor (SM)
	Speed ratio	For AMs: 1: 100 (SVC) For SMs: 1: 20 (SVC)
	Speed control accuracy	$\pm 0.2\%$ (SVC)
	Speed fluctuation	$\pm 0.3\%$ (SVC)
	Torque response	<10ms (SVC)
	Torque control accuracy	5% (SVC)
	Starting torque	For AMs: 0.25Hz/150% (SVC) For SMs: 2.5 Hz/150% (SVC)
	Overload capacity	150% of the rated current for 60s 180% of the rated current for 10s
Peripheral interface	Terminal analog input resolution	No more than 20mV
	Terminal digital input resolution	No more than 2ms
	Analog input	Two inputs. AI1: 0–10V/0–20mA; AI2: 0–10V
	Analog output	One output. AO1: 0–10V/0–20mA
	Digital input	Four regular inputs. Max. frequency: 1kHz One high-speed input. Max. frequency: 50kHz

Item		Specifications
	Digital output	One Y terminal open collector output
	Relay output	Two programmable relay outputs RO1A: NO; RO1B: NC; RO1C: common RO2A: NO; RO2B: NC; RO2C: common Contact capacity: 3A/AC250V, 1A/DC30V Note: Only output of relay 1 is available for EU models.
Environment requirement	Temperature of running environment	-10–50°C, no need of derating Note: Derating is required when the ambient temperature exceeds 50°C. For details, see A.1 Derating due to temperature.
	Ingress protection (IP) rating	IP20
	Pollution degree	Degree 2
Installation method		Wall mounting and DIN rail mounting
Cooling method		220V voltage class: natural cooling for 0.75kW and lower 380V voltage class: natural cooling for 1.5kW and lower Others: Forced air cooling
Certification standard		CE requirements are met.

2.3 Product ratings

Model	Output power (kW)	Input current (A)	Output current (A)
AC 1PH 200V–240V			
GD27-0R4G-S2-B-XX	0.4	6.5	2.5
GD27-0R7G-S2-B-XX	0.75	11	4.2
GD27-1R5G-S2-B-XX	1.5	18	7.5
GD27-2R2G-S2-B-XX	2.2	24.3	10
AC 3PH 200V–240V			
GD27-0R4G-2-B-EU	0.4	3.6	2.5
GD27-0R7G-2-B-EU	0.75	7	4.2
GD27-1R5G-2-B-EU	1.5	11.6	7.5
GD27-2R2G-2-B-EU	2.2	16	10

Model	Output power (kW)	Input current (A)	Output current (A)
GD27-004G-2-B-EU	4	22.3	16
AC 3PH 380V-480V			
GD27-0R7G-4-B-XX	0.75	4.5	2.5
GD27-1R5G-4-B-XX	1.5	6.5	3.7
GD27-2R2G-4-B-XX	2.2	8.8	5.5
GD27-003G-4-B-XX	3	12.2	7.5
GD27-004G-4-B-XX	4	15.6	9.5
GD27-5R5G-4-B-XX	5.5	22.3	14
GD27-7R5G-4-B-XX	7.5	28.7	18.5

Note:

- -XX indicates empty or -EU.
- The VFD input current is measured in cases where the input voltage is 220V/380V without additional reactors.
- The STO function for EU models meets Safety Integrity Level 2 (SIL2).

2.4 Product heat dissipation

Model	Entire machine standby power dissipation (W)	Entire machine full load power dissipation (W)	Heat dissipation (BTU/hr)	Air rate (m ³ /h)	Air rate (CFM) (ft ³ /min)
AC 1PH 200V-240V					
GD27-0R4G-S2-B-XX	5	30	101	-	-
GD27-0R7G-S2-B-XX	5	46	155	-	-
GD27-1R5G-S2-B-XX	5	51	172	26	15
GD27-2R2G-S2-B-XX	5	77	264		
AC 3PH 200V-240V					
GD27-0R4G-2-B-EU	5	26	88	-	-
GD27-0R7G-2-B-EU	5	42	142	-	-
GD27-1R5G-2-B-EU	5	47	159	26	15
GD27-2R2G-2-B-EU	5	68	232		
GD27-004G-2-B-EU	9	125	426	71	42
AC 3PH 380V-480V					
GD27-0R7G-4-B-XX	7	37	125	-	-
GD27-1R5G-4-B-XX	7	48	162	-	-

Model	Entire machine standby power dissipation (W)	Entire machine full load power dissipation (W)	Heat dissipation (BTU/hr)	Air rate (m ³ /h)	Air rate (CFM) (ft ³ /min)
GD27-2R2G-4-B-XX	8	61	209	26	15
GD27-003G-4-B-XX	8	78	266		
GD27-004G-4-B-XX	8	103	350		
GD27-5R5G-4-B-XX	9	168	573	71	42
GD27-7R5G-4-B-XX	9	243	829		

🔗**Note:** -XX indicates empty or -EU.

2.5 Product dimensions and weight

Model	Frame	Outline dimensions WxHxD (mm)	Package outline dimensions WxHxD (mm)	Net weight (kg)	Gross weight (kg)
AC 1PH 200V-240V					
GD27-0R4G-S2-B-XX	A	60x190x155	238x98x205	0.99	1.19
GD27-0R7G-S2-B-XX					
GD27-1R5G-S2-B-XX	B	70x190x155	238x98x205	1.25	1.36
GD27-2R2G-S2-B-XX					
AC 3PH 200V-240V					
GD27-0R4G-2-B-EU	A	60x190x155	238x98x205	0.99	1.19
GD27-0R7G-2-B-EU					
GD27-1R5G-2-B-EU	B	70x190x155	238x98x205	1.25	1.36
GD27-2R2G-2-B-EU					
GD27-004G-2-B-EU	C	90x235x155	298x128x213	1.95	2.2
AC 3PH 380V-480V					
GD27-0R7G-4-B-XX	A	60x190x155	238x98x205	0.99	1.19
GD27-1R5G-4-B-XX					
GD27-2R2G-4-B-XX	B	70x190x155	238x98x205	1.25	1.36
GD27-003G-4-B-XX					
GD27-004G-4-B-XX					
GD27-5R5G-4-B-XX	C	90x235x155	298x128x213	1.95	2.2
GD27-7R5G-4-B-XX					

Note:

- -XX indicates empty or -EU.
- The product exterior structures are divided into A, B, and C.

2.6 Product structure

Warning	
	<ul style="list-style-type: none"> • The Micro USB interface is a software upgrade interface, which requires the use of our company's dedicated burner and connection cable. • After the VFD is powered on, the Micro USB interface on the drive board has strong current, and therefore it cannot be touched or used. <p>Note: A universal USB cable cannot be used by this interface.</p>

Figure 2-1 Product components (taking the 380V 7.5kW VFD model as an example)



No.	Component	No.	Component
1	Input safety protection grounding terminal	9	Input terminal

No.	Component	No.	Component
2	EMC screw	10	Potentiometer knob
3	Cover	11	Nameplate
4	Model bar code	12	Control board terminal
5	Signal grounding terminal (PE)	13	RJ45 network port
6	Micro USB interface (on the control board)	14	Housing
7	Output terminal	15	Micro USB interface (on the drive board)
8	Output safety protection grounding terminal	16	Cooling fan

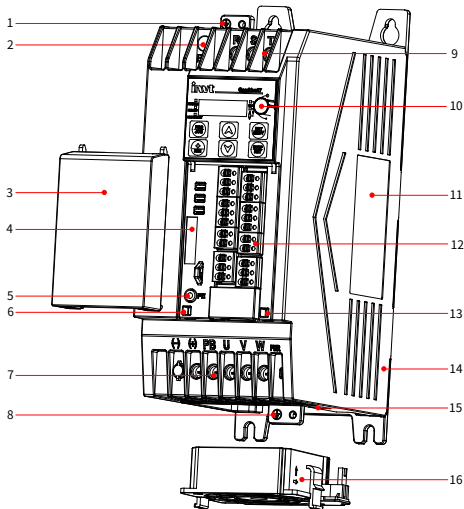
2.7 System configuration

When using the VFD to drive a motor to form a control system, various electrical devices need to be installed on the input and output sides of the VFD to ensure stable system running.

Figure 2-2 System composition

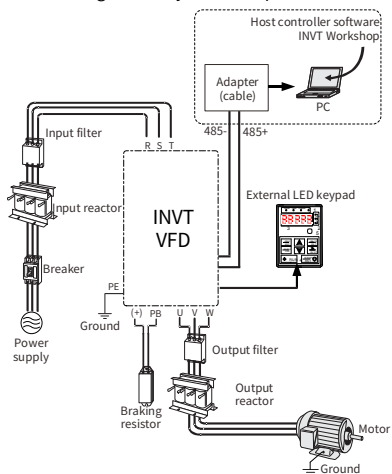









Table 2-1 System configuration

Component	Position	Description
	Breaker	Between the power supply and the VFD input side Device for electric shock prevention and protection against short-to-ground that may cause current leakage and fire. Select residual-current circuit breakers (RCCBs) that are applicable to VFDs and can restrict high-order harmonics, and of which the rated sensitive current for one VFD is larger than 30mA.
	Input reactor	At the VFD input side Accessories used to improve the power factor on the input side of the VFD, and thus restrict high-order harmonic currents.
	Output reactor	Between the VFD output side and the motor, adjacent to the VFD (Optional) Accessory used to lengthen the valid transmission distance of the VFD, which effectively restricts the transient high voltage generated during the switch-on and switch-off of the IGBT module of the VFD.
	Input filter	At the VFD input side (Optional) Input filter: Accessory that restricts the electromagnetic interference generated by the VFD and transmitted to the public grid through the power cable.
	Output filter	Adjacent to the VFD output terminals Try to install the input filter near the input terminal side of the VFD. (Optional) Output filter: Accessory used to restrict interference generated in the wiring area on the output side of the VFD. All the product series can meet the conductivity and transmission requirements of IEC/EN 61800-3 C3 electrical drive systems. Optional external filters can be used to meet the conductivity and transmission requirements of IEC/EN 61800-3 C2 electrical drive systems. Note: Please comply with the technical requirements specified in the appendix of the manual for the assembly of motors,

Component	Position	Description
	Braking resistor	Between the VFD main circuit terminals (+) and PB <ul style="list-style-type: none"> ● Braking unit: Already embedded (only external braking resistor required) ● Braking resistor: Optional and externally connected for all models
	Host controller software	INVT Workshop is used to configure and monitor VFDs. It is mainly used to: <ul style="list-style-type: none"> ● Monitor multiple VFDs. ● Set and monitor function parameters; upload and download function parameters in batches. ● View modified function codes, compare default values, and follow up and query for function codes. ● Query for and follow up status parameters. ● View real-time and historic faults. ● Display function codes in configuration mode. ● Control device startup, stop, forward running, reverse running, and other operations. ● View oscillographic curves, save and replay waveform data, operate waveforms through cursor, and simulate waveform data. Please visit www.invt.com to obtain freely.

For details about option model selection, see Appendix D Peripheral accessories.

2.8 Quick startup

Task	Reference
1. Unpack the box for inspection.	See 3.1 Unpacking inspection.
2. Check whether the VFD connected load and power supply match.	See 2.1 Product nameplate and model.
3. Check the installation environment.	See 3.2 Preparing.
4. Install the VFD on the wall/in the cabinet.	See 3.3 Installation.
5. Perform wiring.	See 4 Electrical installation.
6. Commission the VFD.	See 6 Commissioning.

3 Mechanical installation

3.1 Unpacking inspection

After receiving the product, perform the following steps to ensure the product use safety.

■ Check the package

Before unpacking, check whether the product package is intact—whether the package is damaged, dampened, soaked, or deformed. After unpacking, check whether the interior surface of the packing box is abnormal, for example, in wet condition.

■ Check the machine and parts

After unpacking, check whether the equipment enclosure is damaged or cracked, whether the parts (including the VFD and manual) inside the packing box are complete, and whether the nameplate and label on the product body are consistent with the model ordered.

3.2 Preparing

Only trained and qualified professionals are allowed to carry out the operations mentioned in this chapter. Read the following installation preparation carefully before installation to ensure smooth installation and avoid personal injury or equipment damage.





Warning





- Carry out operations according to instructions presented in 1.4 Safety guidelines. Ensure the VFD power has been disconnected before installation. If the VFD has been powered on, disconnect the VFD and wait for at least the time designated on the VFD, and ensure the POWER indicator is off.
- The VFD installation must be designed and done according to applicable local laws and regulations. INVT does not assume any liability whatsoever for any VFD installation which breaches local laws or regulations.



3.2.1 Installation environment and site

■ Environment requirement

Environment	Requirement	
Temperature		<ul style="list-style-type: none"> -10~+50°C The temperature does not change rapidly. When the VFD is installed in a closed space, such as control cabinet, use a cooling fan or air conditioner for temperature adjustment if necessary. When the temperature is too low, if you want to use the VFD that has been idled for a long time, install an external heating device before the use to eliminate the freeze inside the VFD. Otherwise, the VFD may be damaged.
Relative humidity (RH)		<ul style="list-style-type: none"> The relative humidity (RH) of the air is less than 90%, and there is no condensation. The max. RH cannot exceed 60% in the environment where there are corrosive gases.
Altitude		<ul style="list-style-type: none"> Lower than 1000m When the altitude exceeds 1000m, derate by 1% for every increase of 100m. When the altitude exceeds 3000m, consult our local dealer or office for details.
Vibration		Max. vibration ACC: 5.8m/s ² (0.6g)

■ Location requirement

Location	Requirement	
Indoor		Without electromagnetic radiation sources and direct sunlight. Note: The VFD must be installed in a clean and well-ventilated environment based on the housing IP rating.
		Without foreign objects such as oil mist, metal powder, conductive dust, and water.

Location	Requirement	
	Without radioactive, corrosive, hazard, and combustible and explosive substances. Note: Do not install the VFD onto combustible objects.	
	With low salt content	

3.2.2 Installation direction

The VFD can be installed on the wall or in a cabinet, and it must be installed vertically. It cannot be installed in other directions such as horizontal (lying), horizontal (lateral), or inverted.

Figure 3-1 Installation direction diagram

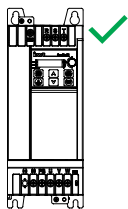

Vertical installation

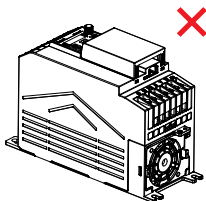

Horizontal installation

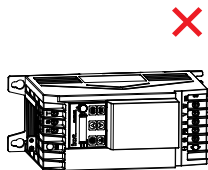

Transverse installation

3.2.3 Installation space

3.2.3.1 Single VFD

Figure 3-2 Installation space diagram of a single VFD

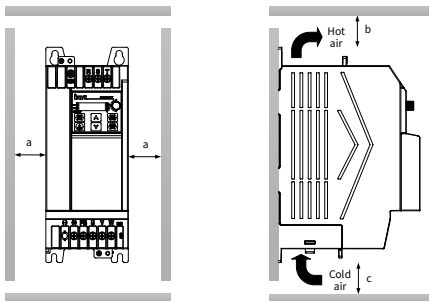

Table 3-1 Installation space dimensions of a single VFD

Frame	Dimensions (mm)		
	a	b	c
A, B, C	≥40	≥100	≥100

3.2.3.2 Multiple VFDs

When installing multiple VFDs, you can install them in parallel. When you install VFDs in different sizes, align the top of each VFD before installation for the convenience of future maintenance.

Figure 3-3 Installation space diagram of multiple VFDs

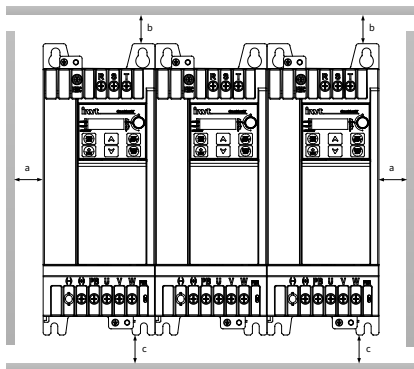

Table 3-2 Installation space dimensions of multiple VFDs

Frame	Dimensions (mm)		
	a	b	c
A, B, C	≥40	≥100	≥100

3.3 Installation and uninstallation

The VFD installation methods vary with the VFD external structures. Please choose the appropriate installation method from the following table based on the specific model and the applicable environment. (✓ indicates the installation method that can be selected.)

Table 3-3 Installation method selection

Frame	Installation method	
	Wall mounting	DIN rail mounting
A	✓	✓
B	✓	✓
C	✓	-

Note: When selecting the DIN rail mounting method for the models in structure frames A and B, you must select a rail mounting bracket. For details about the mounting bracket sizes and order numbers, see D.3.4.3 DIN rail mounting bracket.

3.3.1 Installation

3.3.1.1 Wall mounting

The wall mounting procedure is as follows:

Step 1 Mark the mounting hole positions, and preload the two screws at the top. For details about the mounting hole positions, see C.1 VFD overall dimensions.

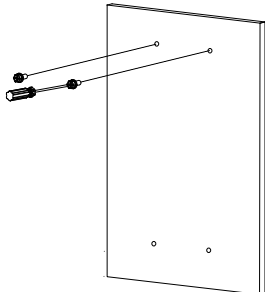

Step 2 Fasten the VFD end with the hardy holes onto the two preloaded screws.

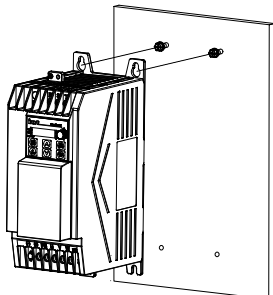

Step 3 Preload the two screws at the bottom.

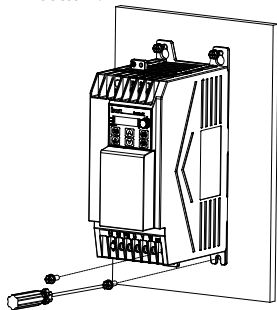

Step 4 Tighten the four preloaded screws.

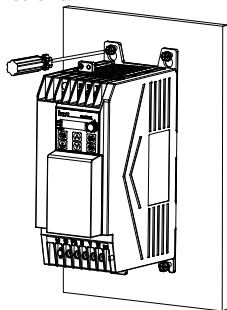

3.3.1.2 DIN rail mounting

The mounting procedure is as follows:

Step 1 Insert rail bracket 1 from the VFD top, and tighten the upper lugs.

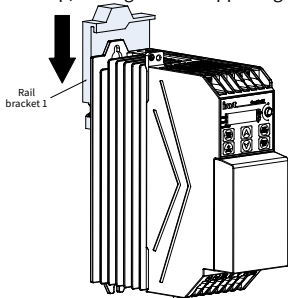

Step 2 Insert rail bracket 2 from the VFD bottom, and tighten the lower lugs.

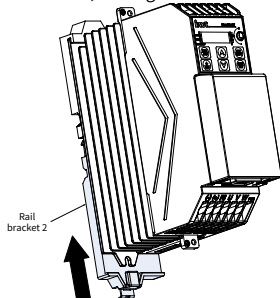

Step 3 Fasten rail brackets 1 and 2. (Ensure that the buckle clicks into place and the sheet metal lock is in the pull-down position.)

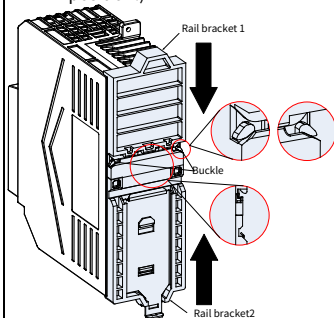

Step 4 Place the VFD with brackets vertically on the DIN rail, and push the sheet metal lock catch upwards to make it tightly engage with the rail.

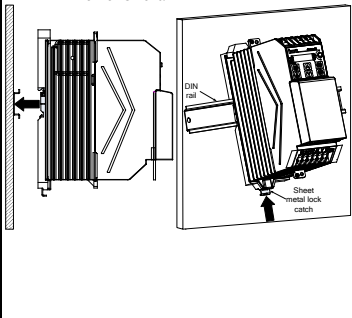

3.3.2 Dismounting

3.3.2.1 DIN rail dismounting

The dismounting procedure is as follows:

Step 1 Use a tool to pull out the sheet metal lock catch downwards until it is fixed, and take out the VFD with the rail bracket from the DIN rail.

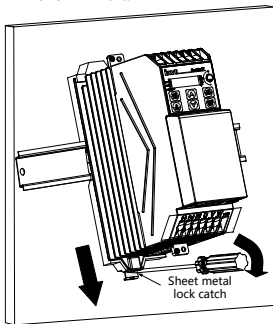

Step 2 Press the buckle in the middle of the DIN rail bracket inward, and then pull out rail brackets 1 and 2.

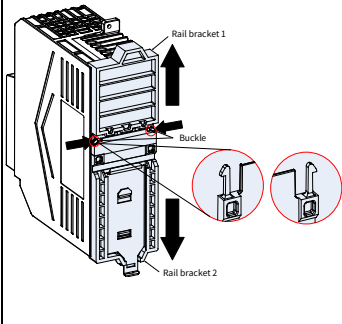

3.3.2.2 Cover dismantling

You need to remove the VFD cover for main circuit and control circuit wiring. The dismantling procedure is as follows:

Step 1 Press the elastic buckles on both sides of the bottom of the cover, and lift them up with force until the buckles detach from the slot.

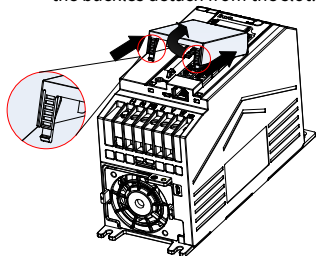

Step 2 Lift the cover and pull it out in tilted way.

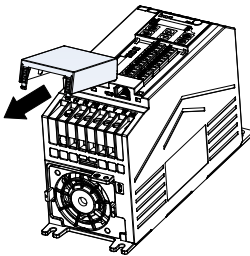

4 Electrical installation

4.1 Insulation inspection

Do not perform any voltage endurance or insulation resistance tests, such as high-voltage insulation tests or using a megohmmeter to measure the insulation resistance, on the VFD or its components. Insulation and voltage endurance tests have been performed between the main circuit and housing of each VFD before delivery. In addition, voltage limiting circuits that can automatically cut off the test voltage are configured inside the VFDs. If you need to conduct insulation resistance testing on the VFD, please contact us.

Note: Before conducting insulation resistance testing on input and output power cables, remove the cable connection terminals from the VFD.

■ Input power cable

Check the insulation conditions of the input power cable of a VFD according to the local regulations before connecting it.

■ Motor cable

Ensure that the motor cable is connected to the motor, and then remove the motor cable from the U, V, and W output terminals of the VFD. Use a megohmmeter of 500V DC to measure the insulation resistance between each phase conductor and the protection grounding conductor. For details about the insulation resistance of the motor, see the description provided by the manufacturer.

Note: If the motor inside is damp, the insulation resistance is reduced. If it may be damp, you need to dry the motor and then measure the insulation resistance again.

4.2 Checking compatible grounding systems

The EU models have been equipped with embedded EMC filters as standard parts and therefore they can be installed on symmetric grounding systems and asymmetric grounding system. When the VFD is used in an asymmetric grounding system, the EMC screw must be removed to avoid the connection between the VFD internal EMC filter capacitor and the grounding potential, which may cause the VFD tripping or damage. The VFD supports the TN, TT, and IT grounding systems.

System		Model with embedded EMC filter
Symmetric grounding system	Neutral grounded TN system	No need to remove EMC screws
	Neutral grounded TT system	

System		Model with embedded EMC filter
Asymmetric grounding system	Phase grounded TN system	Need to remove EMC screws
	TT system without neutral grounded	
	IT system	

Table 4-1 Asymmetric grounding system description

System	Description	Systematic diagram	Remarks
TN	The power neutral point is grounded. The exposed conductive part of device is directly electrically connected to the power neutral point.		The TN system also carries a grounding phase cable, for example grounding phase cable R. The TN system supports the N line and E line are combined but also the lines are separated.
TT	The power neutral point is grounded. The exposed conductive part of electrical device is directly grounded.		TT system with the N line.
IT	The power neutral point is not grounded or the power is grounded with a high resistor. The exposed conductive part of electrical device is directly grounded.		TT system without the N line.

Figure 4-1 EMC screw

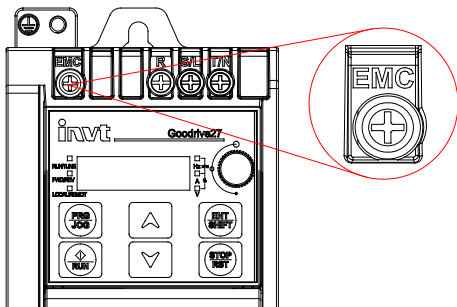

Note:

- Do not remove the EMC screw when the VFD is live.
- Disconnecting the EMC filter will reduce the VFD electromagnetic compatibility, which may cause the failure to meet the EMC specification requirements.
- For the models with embedded EMC filter, the common-mode capacitor circuit is grounded to the heat sink through EMC screw, forming a loop path for high-frequency noise and releasing high-frequency interference; if leakage protection is applied during startup when a leakage circuit breaker has been configured, disconnect the EMC screw.

4.3 Cable selection and routing

4.3.1 Cable selection

Power cable

Power cables mainly include input power cables and motor cables. Comply with local regulations to select cables.

To meet the EMC requirements stipulated in the CE standards, it is recommended to use symmetrical shielded cables as input motor cables and power cables, as shown in Figure 4-2. Compared with four-core cables, symmetrical shielded cables can reduce electromagnetic radiation as well as the current and loss of the motor cables.

Figure 4-2 Symmetrical shielded cable and four-core cable

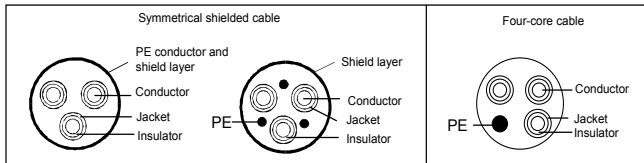
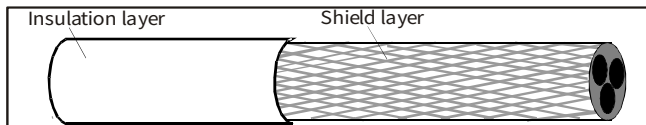

Figure 4-3 Cable cross section

**Note:**

- The input power cables and motor cables must be able to carry the corresponding load currents.
- Figure 4-3 shows the minimum requirement on motor cables of VFD. The cable must consist of a layer of spiral-shaped copper strips. The denser the shield layer is, the more effectively the electromagnetic interference is restricted.
- The cable conductor temperature limit is 70°C. If you use a cable with the conductor temperature limit of 90°C, the cable must comply with relevant national standards and specifications.
- If the electrical conductivity of the motor cable shield layer does not meet the requirements, a separate PE conductor must be used.
- The cross-sectional area of the shielded cables must be the same as that of the phase conductors if the cable and conductor are made of materials of the same type.
- To effectively restrict the emission and conduction of radio frequency (RF) interference, the conductivity of the shielded cable must be at least 1/10 of the conductivity of the phase conductor.
- This requirement can be well met by a copper or aluminum shield layer.

Control cable

Control cables mainly include analog signal control cables and digital signal control cables. Analog signal control cables use twisted-pair double shielded cables, with a separate shielded twisted pair for each signal and different ground wires for

different analog signals. For digital signal control cables, double-shielded cables are preferred, but single-shielded or unshielded twisted pairs can also be used. For details, see D.1.2 Control cable.

4.3.2 Cable arrangement

Figure 4-4 shows the cable routing and wiring distance.

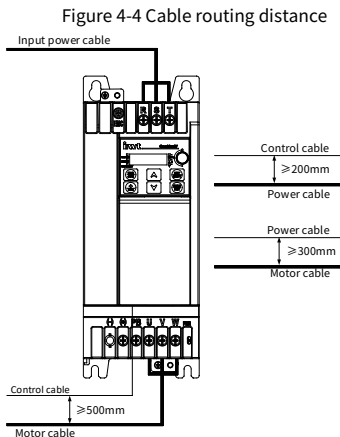

Note:

- Motor cables must be arranged away from other cables. The du/dt of the VFD output may increase electromagnetic interference on other cables.
- Motor cables cannot be routed with other cables in parallel for long distances.
- If the control cable and power cable must cross each other, ensure that the angle between them is 90° .
- The motor cables of several VFDs can be arranged in parallel. It is recommended that you arrange the motor cables, input power cables, and control cables separately in different trays.
- The cable trays must be connected properly and well grounded.
- Other cables cannot cross the VFD.

4.4 Main circuit wiring

4.4.1 Main circuit wiring

Figure 4-5 Main circuit wiring diagram

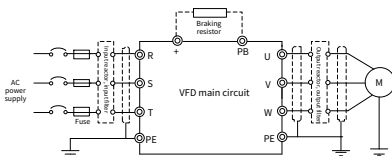

Note: The fuse, input reactor, input filter, output reactor, and output filter are optional parts. For details, see Appendix D Peripheral accessories.

4.4.2 Main circuit terminals

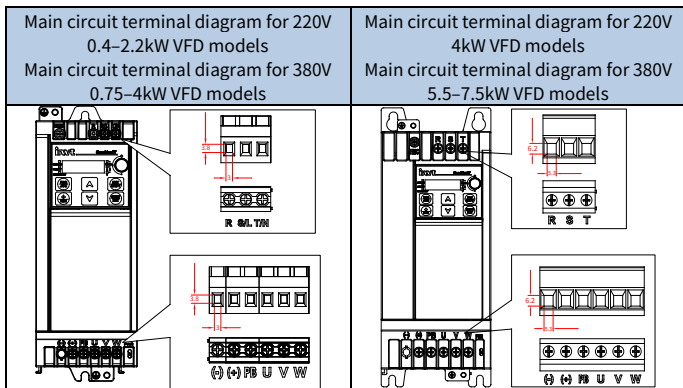

Terminal symbol	Function description
R/L, S, T/N	3PH (or 1PH) AC input terminals, connected to the grid.
U, V, W	3PH AC output terminals, connected to the motor usually.
PB, (+)	Connected to the external braking resistor terminals.
(+), (-)	Busbar positive/negative terminal, used for sharing the DC busbar in VFD paralleling.
	Grounding terminal for safe protection; each machine must carry two PE terminals and proper grounding is required.

Note:

- It is recommended to use a symmetrical motor cable. Please ground the grounding conductor in the motor cable at the VFD end and the motor end.
- The (-) terminal is optional for customization, unavailable for standard and EU models.

4.4.3 Wiring procedure

Step 1 Connect the yellow and green grounding line of the input power cable to the VFD grounding terminal \oplus , connect the 3PH input cable to the R, S, and T terminals, and tighten up.

Figure 4-6 Wiring diagram of input power cables

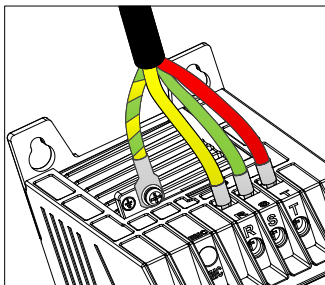

Step 2 Connect the yellow and green grounding line of the motor cable to the VFD PE terminal, connect the motor 3PH cable to the U, V, and W terminals, and tighten up.

Figure 4-7 Wiring diagram of motor cables

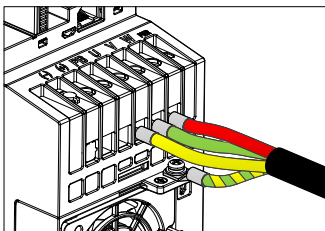

Step3 Connect optional parts such as the braking resistor that carries cables to designated positions. See 4.4.1 Main circuit wiring.

Step4 Fasten all the cables outside the VFD mechanically if allowed.

Figure 4-8 Screw installation diagram

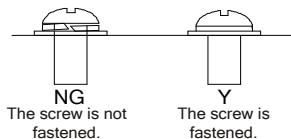

4.5 Control circuit wiring

4.5.1 Control circuit wiring

Figure 4-9 Control circuit wiring diagram

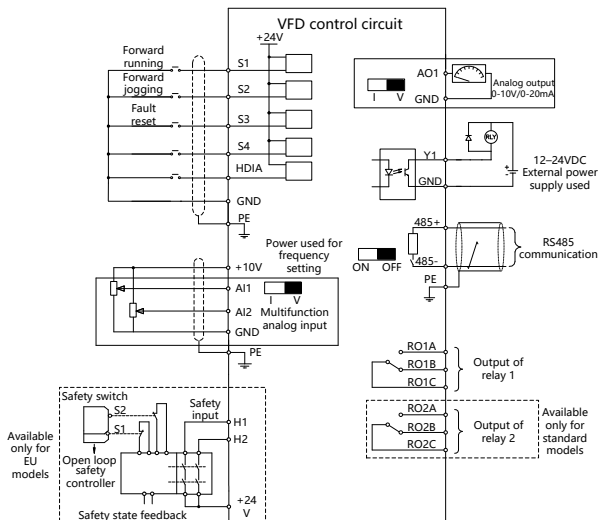

Note: () : Shield layer / : Twisted pair

4.5.2 Control circuit terminals

Figure 4-10 Control circuit terminal diagram

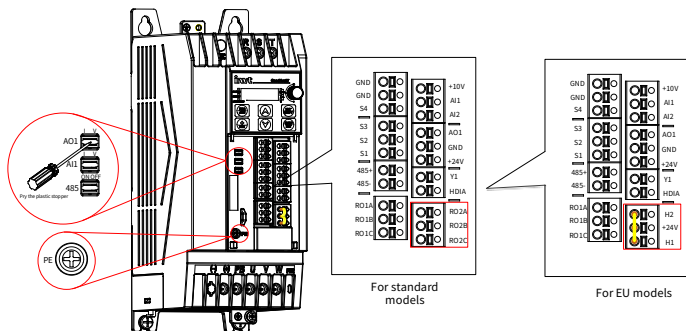

Terminal	Function
+10V	Locally provided +10V power supply
AI1	Analog input. Range: 0–10V/0–20mA. Whether voltage or current is used for input is set through the DIP switch.
AI2	Analog input. Range: 0V–10V
AO1	Analog output. Range: 0–10V/0–20mA. Whether voltage or current is used for output is set through the DIP switch.
RO1A	Relay output. RO1A: NO; RO1B: NC; RO1C: common Contact capacity: 3A/AC 250V, 1A/DC 30V
RO1B	
RO1C	
RO2A	Relay output. RO2A: NO; RO2B: NC; RO2C: common Contact capacity: 3A/AC 250V, 1A/DC 30V
RO2B	
RO2C	
GND	Power reference ground
Y1	Switch capacity: 50mA/30V. Output frequency range: 0–1kHz
485+	RS485 differential signal communication port. The standard RS485 communication interface should use shielded twisted pair. Determine whether to connect the 120Ω terminal matching resistor of RS485 communication through the DIP switch.
485-	
+24V	User power supply provided by the VFD. Max. output current: 100mA
S1–S4	Active input high level range: 16–30V

Terminal	Function
	Active input low level range: 0–2V Max. input frequency: 1kHz Programmable digital input terminals, the functions of which can be set through the related parameters.
HDIA	Channel for both high-speed pulse input and digital input Max. input frequency: 50kHz Duty ratio: 30%–70%
H1	Safe torque off (STO) inputs STO redundant input, connected to the external NC contact. When the contact opens, STO acts and the VFD stops output.
H2	Safety input signal wires use shielded wires whose length is within 25m. The H1 and H2 terminals are short connected to +24V by default. Remove the jumper from the terminals before using the STO function.

4.5.3 Input/output signal wiring

4.5.3.1 Digital input/output signal wiring

The VFD supports only the NPN wiring method.

■ Digital input signal wiring

Figure 4-11 NPN mode

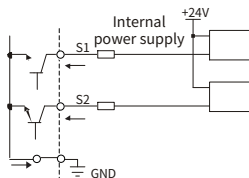

■ Digital output signal wiring

Figure 4-12 Y1 terminal wiring

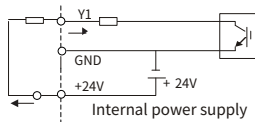

4.5.3.2 Analog input signal wiring

When the analog voltage signal connection is weak, it is prone to external noise interference. Therefore, shielded twisted pair cables are generally used, and the wiring distance should be within 20m. The lead line of the shield layer should be as short as possible and needs to be fixed to the VFD signal grounding \oplus with screws, as shown in Figure 4-13.

Figure 4-13 Analog input terminal wiring

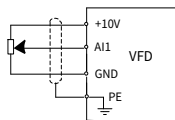
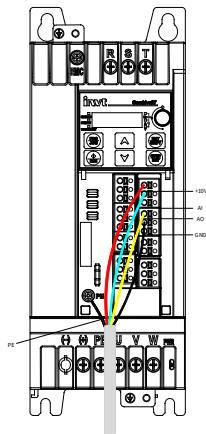
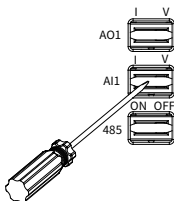

Figure 4-14 PE shield layer wiring



Note:

- When selecting current signal input for AI1, pry the plastic stopper of AI1 and turn the AI1 switch to the "I" side.
- The method for AO1 current output type and RS485 matching resistor selection is similar to the preceding.



- In some cases where the analog signal is severely disturbed, a filtering capacitor or magnetic ring needs to be installed on the analog signal source side. At least 3 turns are required to pass through the same phase.

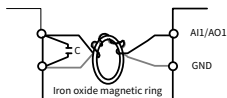

4.6 Power distribution protection

Warning



- Do not connect any power source to the VFD output terminals U, V and W. The voltage applied to the motor cable may cause permanent damage to the VFD.

■ Power cable and VFD protection

In case of short circuit, the fuse protects input power cables to avoid damage to the VFD; if internal short-circuit occurs to the VFD, it can protect neighboring equipment from being damaged. Figure 4-15 shows the wiring.

Figure 4-15 Fuse configuration

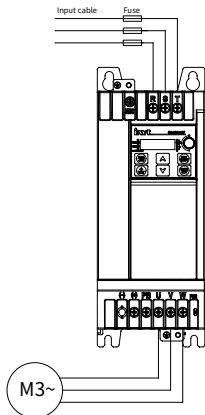

⚡**Note:** Select the fuse according to D.2 Breaker and electromagnetic contactor.

■ Motor and motor cable short-circuit protection

If the motor cable is selected based on VFD rated current, the VFD is able to protect the motor cable and motor without other protective devices during short circuit.

⚡**Note:** If the VFD is connected to multiple motors, use a separated thermal overload switch or breaker to protect the cable and motor, which may require the fuse to cut off the short circuit current.

■ Motor thermal overload protection

When overload is detected, the power must be cut off. The VFD is equipped with the motor thermal overload protection function, which can block output and cut off the current (if necessary) to protect the motor.

■ Bypass connection protection

In scenarios which require normal system operation in the event of VFD failure, the power/variable frequency conversion circuit needs to be configured.

In scenarios where the VFD is used only soft startup, power-frequency running is directly performed after the startup, which requires bypass connection.

If VFD status needs to be switched frequently, you can use the switch which carries mechanical interlock or a contactor to ensure motor terminals are not connected to input power cables and VFD output ends simultaneously.

5 Keypad operation guidelines

5.1 Keypad panel display

The VFD has been equipped with a LED film keypad as a standard configuration part. You can use the keypad to control the start and stop, read status data, and set parameters of the VFD.

Figure 5-1 Standard LED keypad







Note:

- When mounting the keypad (including parameter copying keyboard and common keyboard) externally, use a standard RJ45 crystal head network cable as the keyboard extension cable, and mount it on the front door panel of the cabinet by using M3 screws or optional keyboard mounting bracket.
- When the external parameter copying keypad is valid, the local LED film keypad is not on; when the external common keypad is valid, both the external common keypad and the local LED film keypad are on.

5.1.1 Status indicator

Indicator	Status	Definition
RUN/TUNE	<input checked="" type="checkbox"/> ON	The VFD is running.
	<input type="checkbox"/> Blink	The VFD is in parameter autotuning.
	<input type="checkbox"/> Off	The VFD is stopped.
FWD/REV	<input checked="" type="checkbox"/> ON	The VFD runs reversely.
	<input type="checkbox"/> Off	The VFD runs forward.

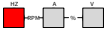
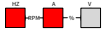
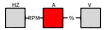
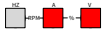
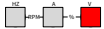
Indicator	Status	Definition	
LOCAL/REMOT	 ON	The VFD uses communication as the command running channel.	
	 Blink	The VFD uses terminal as the command running channel.	
	 Off	The VFD uses keypad as the command running channel.	
RUN/TUNE	 On, displaying the fault code	The VFD is in fault state.	
FWD/REV	 Blinking at the same time	The VFD is in pre-alarm state.	
LOCAL/REMOT			
Unit indicator	On: Unit displayed on the keypad currently		
		Hz	Frequency unit
		RPM	Rotation speed unit
		A	Current unit
		%	Percentage
		V	Voltage unit







Note: The unit indicator blinking and turning-on are generally used to distinguish different stop and running parameter display.

5.1.2 Display area

The display area displays a 5-digit value, including fault alarm code, set frequency, output frequency, and functional status data.

Display	Means	Display	Means	Display	Means	Display	Means
0	0	1	1	2	2	3	3
4	4	5	5	6	6	7	7
8	8	9	9	A	A	b	b
C	C	d	d	E	E	F	F
H	H	I	I	L	L	N	N
n	n	O	O	P	P	r	r
S	S	t	t	U	U	v	v
.	.	-	-				

5.1.3 Key

Key		Function
	Programming/ Multifunction shortcut key	Press it to enter or exit level-1 menus or delete a parameter. Press and hold it (at least 1s) to implement the function defined by the ones place of P07.02, which is jogging by default.
	Confirmation/ Shifting key	Press it to enter menus in cascading mode or confirm the setting of a parameter. Press it to select display parameters in the interface for the VFD in stopped or running state. Press and hold it (at least 1s) for cyclic shifting during parameter setting.
	Up key	Press it to increase data or move upward.
	Down key	Press it to decrease data or move downward.
	Run key	Press it to run or perform autotuning under keypad operation mode.
	Stop/Reset key	P07.04 specifies the validity of the key function.

Key	Function
	Press it to stop running or autotuning in running state. Press it to reset in fault alarm state.
	Potentiometer (AI3) When mounting the parameter copying keypad externally, the input source of AI3 is the potentiometer of this external keypad. When using the local LED film keypad or mounting a common keypad externally, the input source of AI3 is specified by P05.53.

5.2 Keypad display

The keypad display content varies under different states. The following describes the keypad display content under different states.

Figure 5-2 Status interface display



5.2.1 Displaying stopped-state parameters

When the VFD is in stopped state, and the keypad is not in the function code viewing or editing state, the keypad displays stopped-state parameters. By setting P07.07, you can select different stopped-state parameters. Press **ENT/SHIFT** to switch the parameters.

5.2.2 Displaying running-state parameters

When the VFD is in running state, and the keypad is not in the function code viewing or editing state, the keypad displays running-state parameters. By setting P07.05 and P07.06, you can select different running-state parameters. Press **ENT/SHIFT** to switch the parameters.

5.2.3 Fault display

When the VFD is in fault state, and the keypad is not in the function code viewing or editing state, the keypad displays the fault code in blinking way. You can perform fault reset by using the **STOP/RST** key, control terminals, or communication commands. If the fault persists, the fault state and fault code display are kept.

When the VFD is in fault display state, and the keypad is in the function code viewing or editing state, the keypad automatically returns to the fault state display if there is no operation within 20s. When there is no fault with the VFD, after entering the third-level menu of changing a function code with the attribute "●", the value of the function code will be displayed continuously. In other cases, if there is no operation on the keypad within 1 minute, the keypad will automatically return to the stopped-state or running-state parameter display from the function code viewing or editing state.

5.3 Operation procedure

5.3.1 Modifying function parameters

The keypad contains three levels of menus according to operation editing settings.

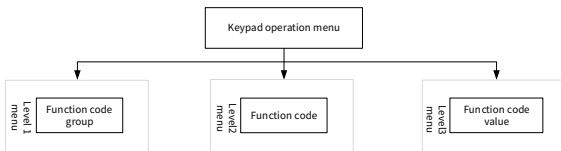



When the VFD is in stopped, running, or fault display state :

Press **PRG/JOG** to enter the level-one menu (if a user password has been set, see the description of P07.00).

Under the level-two menu, press **ENT/SHIFT** to enter the next-level menu.

Under the level-three menu, press **ENT/SHIFT** to save the current function code value and enter the level-two menu of the next function code.

Note: Under various levels of menus, press **PRG/JOG** to return to the previous

level of menu, press  or  to increase or decrease the value of the current blinking bit, and press and hold  to switch blinking bits rightward in circular mode.

The following takes P03.20 as an example to describe how to modify a function parameter in the stopped-state parameter display interface:

Figure 5-3 Modifying a parameter

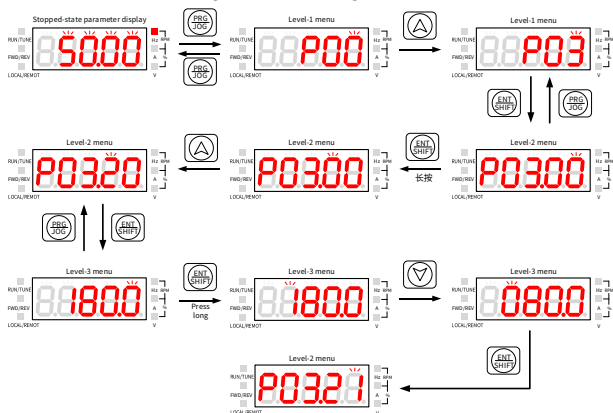

Note: When P00.18 is set to 3, any function code value does not blink, and any function code value cannot be modified.

5.3.2 Setting a password for the VFD

The VFD provides the user password protection function. When P07.00 is set to a non-zero value, the function code editing state is exited, and password protection will take effect within one minute. After the password takes effect, when the VFD is in the stopped, running, or fault display state, you need to type the user password after pressing the  key so as to enter the function code viewing and editing state.

The following takes setting the user password 10001 as an example to describe how

to set a password for the VFD in the stopped-state parameter display interface:

Figure 5-4 Setting a password

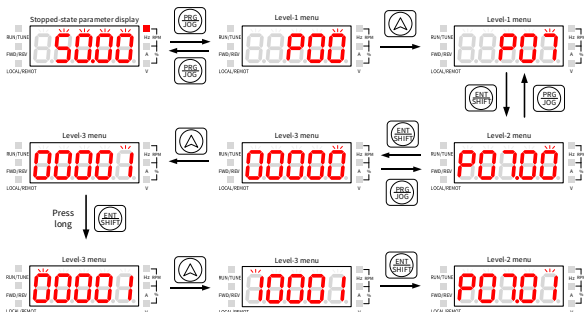

5.3.3 Viewing function parameters

The VFD provides the status viewing function. The following describes how to view function parameters in the stopped-state parameter display interface when the password is 10001:

Figure 5-5 Viewing a function code

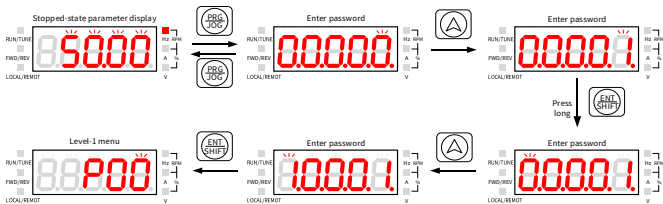

6 Commissioning

The simplified VFD commissioning flowchart is as follows:

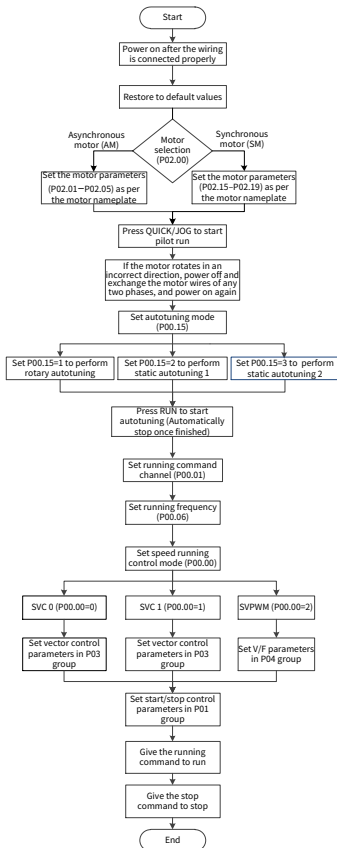

6.1 Motor parameter setting

The VFD supports the control of three-phase AC asynchronous motors and permanent magnet synchronous motors. The VFD uses a set of motor parameters, namely P02 group parameters, for motor control.

6.1.1 Motor type selection

You can select the motor type by setting P02.00.

Function code	Name	Default	Setting range	Description
P02.00	Type of motor 1	0	0-1	0: Asynchronous motor (AM) 1: Synchronous motor (SM)

Note: The types of motors that are driven at the same type must be the same.

6.1.2 Rated motor parameter setting

- Set the rated parameters of three-phase AC asynchronous motors according to the motor nameplate.

Parameters P02.01–P02.05 are the parameters of asynchronous motor 1.

Function code	Name	Default	Setting range	Description
P02.01	Rated power of AM 1	Model depended	0.1–3000.0kW	-
P02.02	Rated frequency of AM 1	50.00Hz	0.01Hz–P00.03	P00.03 specifies the max. output frequency.
P02.03	Rated speed of AM 1	Model depended	1–60000rpm	-
P02.04	Rated voltage of AM 1	Model depended	0–1200V	-
P02.05	Rated current of AM 1	Model depended	0.08–600.00A	-

- Set the rated parameters of three-phase permanent magnetic synchronous motors according to the motor nameplate.

Parameters P02.15–P02.19 are the parameters of synchronous motor 1.

Function code	Name	Default	Setting range	Description
P02.15	Rated power of SM 1	Model depended	0.1–3000.0kW	-
P02.16	Rated frequency of SM 1	50.00Hz	0.01Hz–P00.03	P00.03 specifies the max. output frequency.
P02.17	Number of pole pairs of SM 1	2	1–128	-
P02.18	Rated voltage of SM 1	Model depended	0–1200V	-
P02.19	Rated current of SM 1	Model depended	0.08–600.00A	-

6.2 Motor parameter autotuning setting

To improve motor control effect, you are recommended to set motor rated parameters according to the motor nameplate after the first power on, and then conduct parameter autotuning. You can select an autotuning mode based on actual conditions.

Motor parameters have a significant impact on the calculation of the control model, especially in the case of vector control, which requires motor parameter autotuning first.

After setting motor parameters, you can set P00.15 to select the autotuning method. The setting procedure is as follows:

Step 1 Set P00.01 to 0 to select the keypad.

Step 2 Set P00.15 to select one method from three autotuning methods.

Step 3 Press **RUN** to give the start command. The motor enters autotuning.

Function code	Name	Default	Setting range	Description
P00.15	Motor parameter autotuning	0	0–3	0: No operation 1: Rotary autotuning 1 2: Static autotuning 1 (Comprehensive) 3: Static autotuning 2 (Partial autotuning)

Note:

- When P00.15 is set to 1, disconnect the motor from the load to put the motor in static and no-load state.
- When P00.15 is set to 2 or 3, there is no need to disconnect the motor from the load.

Table 6-1 Obtained motor parameters in different autotuning methods

Set value of P00.15	Autotuning parameters	
	AM 1	SM 1
1	P02.06–P02.14	P02.20–P02.23
2	P02.06–P02.10	P02.20–P02.22
3	P02.06–P02.08	

Note: The synchronous motor back-EMF constant P02.23 can also be calculated based on the parameters on the motor nameplate, and there are three calculation methods.

Method 1: If the back-EMF coefficient K_e is marked on the nameplate, the calculation is as follows:

$$E = (K_e * n_N * 2\pi) / 60$$

Method 2 : If the back-EMF E' (unit: V/1000r/min) is marked on the nameplate, the calculation is as follows:

$$E = E' * n_N / 1000$$

Method 3: If none of the two preceding parameters is marked on the nameplate, the calculation is as follows:

$$E = P / (\sqrt{3} * I)$$

In the preceding formulas, n_N indicates the rated rotation speed, P indicates the rated power, and I indicates the rated current.

6.3 Running command selection

Running commands are used to control the start, stop, forward running, reverse running, and jogging of the VFD. The channels of running commands include keypad, terminal, and communication. Set P00.01 to select a channel of running commands.

Function code	Name	Default	Setting range	Description
P00.01	Channel of running commands	0	0–2	0: Keypad 1: Terminal 2: Communication

Keypad

When P00.01 is set to 0, you can control the VFD start or stop through the keypad key **RUN** or **STOP/RST**. After pressing the **RUN** key, the VFD starts running, and the **RUN** indicator turns on. In running state, if you press the **STOP/RST** key, the VFD stops running, and the **RUN** indicator turns off. For details about keypad operations, see 5 Keypad operation guidelines.

Terminal

When P00.01 is set to 1, you can control the VFD start or stop through terminals. The setting procedure is as follows:

Step 1 Set P05.01–P05.09 to the required running commands. For example, to set S2 to reverse running, set P05.02 to 2.

Function code	Name	Default	Setting range	Description
P05.01– P05.09	Function selection of multifunction digital input terminals (S1–S8, and HDIA)	1	0–95	1: Run forward (FWD) 2: Run reversely (REV) 3: Three-wire running control (Sin) 4: Jog forward 5: Jog reversely 6: Coast to stop 7: Reset faults
		4		
		7		
		0		
		0		
		0		
		0		
		0		

Step 2 Set P05.13 (Terminal control mode).

Function code	Name	Default	Setting range	Description
P05.13	Terminal control mode	0	0–3	0: Two-wire control mode 1 1: Two-wire control mode 2 2: Three-wire control mode 1 3: Three-wire control mode 2

Two-wire control mode 1: P05.13= 0

The enabling is integrated with the direction. This mode is widely used. The defined FWD/REV terminal command determines the motor rotation direction.

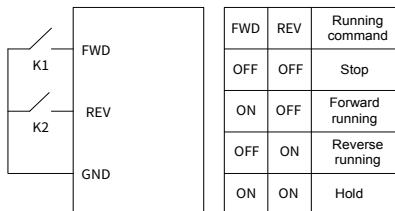

Two-wire control mode 2: P05.13= 1

The enabling separated from the direction. In this mode, FWD is the enabling terminal. The direction depends on the defined REV state.

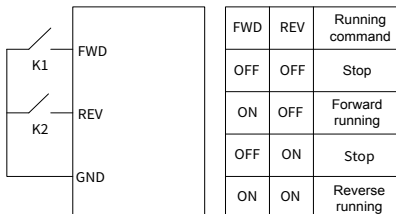

Three-wire control mode 1: P05.13= 2

This mode defines Sin as the enabling terminal, and the running command is generated by FWD, while the direction is controlled by REV. During running, the Sin terminal needs to be closed, and terminal FWD generates a rising edge signal, then the VFD starts to run in the direction set by the state of terminal REV; the VFD needs to be stopped by disconnecting terminal Sin.

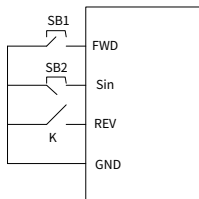

The direction control is as follows during running:

Sin	REV	Previous direction	Present direction
ON	OFF→ON	Forward running	Reverse running
		Reverse running	Forward running
ON	ON→OFF	Reverse running	Forward running
		Forward running	Reverse running
ON→OFF	ON	Decelerate to stop	
	OFF		

Three-wire control mode 2: P05.13= 3

This mode defines Sin as the enabling terminal, and the running command is generated by FWD or REV, but the direction is controlled by both FWD and REV. During running, the Sin terminal needs to be closed, and terminal FWD or REV generates a rising edge signal to control the running and direction of the VFD; the VFD needs to be stopped by disconnecting terminal Sin.

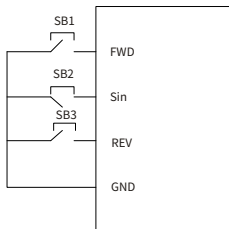

The direction control is as follows during running:

Sin	FWD	REV	Running direction
ON	OFF→ON	ON	Forward running
		OFF	Forward running
ON	ON	OFF→ON	Reverse running
	OFF		Reverse running
ON→OFF			Decelerate to stop

Note: For two-wire controlled running mode, when the FWD/REV terminal is valid, if the VFD stops due to a stop command given by another source, the VFD does not run again after the stop command disappears even if the control terminal FWD/REV is still valid. To make the VFD run, you need to trigger FWD/REV again, for example, PLC single-cycle stop, fixed-length stop, and valid STOP/RST stop during terminal control. (See P07.04.)

Communication

When P00.01 is set to 2, you can control the VFD start or stop by setting commands through Modbus communication. For details, see 7 Communication.

6.4 Frequency setting

The VFD supports multiple kinds of frequency reference modes, which can be categorized into two types: main reference channel and auxiliary reference channel.

There are two main reference channels, namely frequency reference channel A and frequency reference channel B. These two channels support simple arithmetical operation between each other, and they can be switched dynamically.

There is one auxiliary reference channel, namely the UP/DOWN terminal. You can set P08.44 to set related functions of the UP/DOWN terminal.

The actual VFD reference is comprised of the main reference channel and auxiliary reference channel. The schematic diagram is as follows:

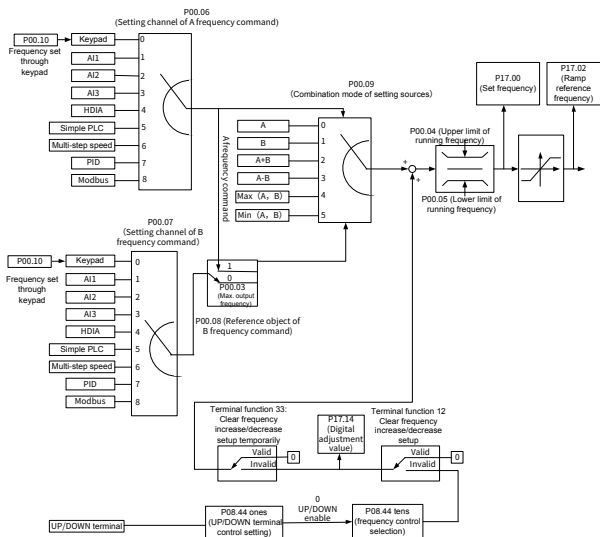

For example, when selecting function 10 or 11 for function code P05.01 or P05.02, S1 or S2 is the Up or Down terminal. When S1 or S2 is closed, the reference frequency

increases or decreases quickly. The increase or decrease change rate is determined by P08.45 or P08.46, as shown in the following figure:

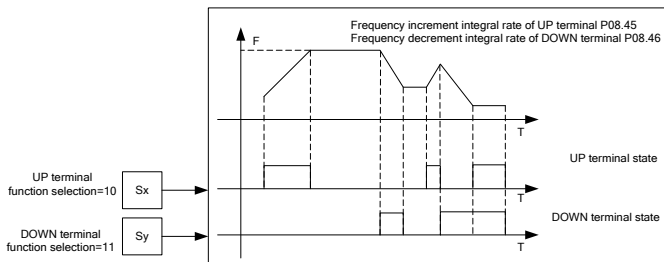

6.4.1 Combination of frequency setting source

6.4.1.1 Combination mode of setting source

Set P00.09 to select the combination mode of setting source.

Function code	Name	Default	Setting range	Description
P00.09	Combination mode of setting source	0	0-5	0: A 1: B 2: (A+B) 3: (A-B) 4: Max(A, B) 5: Min(A, B)

6.4.1.2 Frequency channel switchover

You can set any of function codes P05.01–P05.09 to any of functions 13–15 to switch frequency channels. The setting procedure is as follows:

Step 1 Select any of multifunction digital input terminals S1–S8 and HDIA as an external input terminal.

Step 2 Set P05.01–P05.09 to any of functions 13–15.

Function code	Name	Default	Setting range	Description
P05.01–P05.09	Function selection of multifunction	1	0-95	13: Switch between A setting and B setting 14: Switch between
		4		
		7		

Function code	Name	Default	Setting range	Description
	digital input terminals (S1-S8, and HDIA)	0		combination setting and A setting 15: Switch between combination setting and B setting
		0		
		0		
		0		
		0		
		0		

The combinations are described in the following table:

Present reference channel P00.09	Multifunction digital input terminal function 13 (Switch from channel A to channel B)	Multifunction digital input terminal function 14 (Switch from combined setting to channel A)	Multifunction digital input terminal function 15 (Switch from combined setting to channel B)
A	B	-	-
B	A	-	-
A+B	-	A	B
A-B	-	A	B
Max(A, B)	-	A	B
Min(A, B)	-	A	B

6.4.2 Frequency setting method

The VFD provides multiple frequency setting methods, including setting P00.06 (Setting channel of A frequency command) and setting P00.07 (Setting channel of B frequency command).

Function code	Name	Default	Setting range	Description
P00.06	Setting channel of A frequency command	0	0-8	0: Keypad digital 1: AI1 2: AI2 3: AI3 4: High-speed pulse HDIA 5: Simple PLC program 6: Multi-step speed running 7: PID control
P00.07	Setting channel of B frequency command	1		

Function code	Name	Default	Setting range	Description
				8: Modbus communication

6.4.2.1 Setting frequency through the keypad

When P00.06/P00.07 (Setting channel of A/B frequency command) is set to 0 (keypad digital as the setting channel), and P00.10 specifies the original value of the digital setting based VFD frequency.

Function code	Name	Default	Setting range	Description
P00.10	Setting frequency through the keypad	50.00Hz	0.00Hz–P00.03	P00.03 specifies the max. output frequency. When the setting channel of A and B frequency commands is keypad, P00.10 specifies the original value of the digital setting based VFD frequency.

6.4.2.2 Setting frequency through analog

You can set P00.06 or P00.07 to 1, 2, or 3 (setting frequency through analog). For details, see 6.9.2 Analog input and output terminal functions.

6.4.2.3 Setting frequency through high-speed pulse

You can set P00.06 or P00.07 to 4 (setting frequency through high-speed pulse).

6.4.2.4 Setting frequency through simple PLC

You can set P00.06 or P00.07 to 5 (setting frequency through simple PLC).

Simple PLC is a multi-step speed generator, and the VFD can change the running frequency and direction automatically based on the running time to fulfill process requirements. The VFD can realize 16-step speed control, and provide four groups of acceleration/deceleration time for selection. After the set PLC completes one cycle (or one step), one ON signal can be output by the multifunction relay. See the following figure.

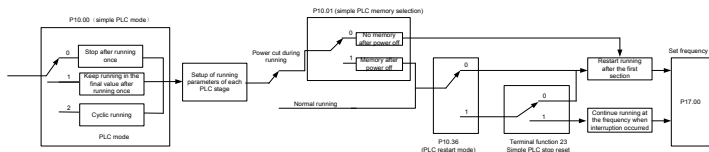

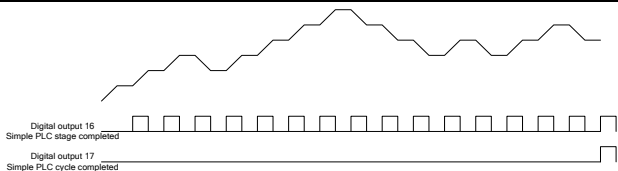

When simple PLC is selected for frequency giving, you need to set P10.02–P10.33 to determine the running frequency and running time of each step. The schematic diagram is as follows:

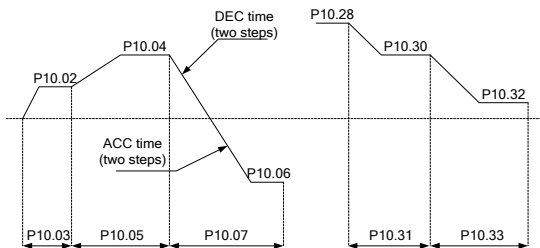

Note: The sign of multi-step speed determines the running direction of simple PLC, and a negative value means reverse running. ACC time means the time needed if the VFD speeds up from 0Hz to the max. output frequency (P00.03). DEC time means the time needed if the VFD speeds down from the max. output frequency (P00.03) to 0Hz. Select corresponding ACC/DEC time, and then convert 16-bit binary number into hexadecimal number, finally, and then set corresponding function codes.

Function code	Name	Default	Setting range	Description
P00.11	ACC time 1	Model depended	0.0–3600.0s	The VFD has four groups of ACC/DEC time, which can be selected by P05. The factory default ACC/DEC time of the VFD is the first group.
P00.12	DEC time 1	Model depended		
P08.00	ACC time 2	Model depended		
P08.01	DEC time 2	Model depended		

Function code	Name	Default	Setting range	Description
P08.02	ACC time 3	Model depended		
P08.03	DEC time 3	Model depended		
P08.04	ACC time 4	Model depended		
P08.05	DEC time 4	Model depended		
P10.34	ACC/DEC time of steps 0–7 of simple PLC	0x0000	0x0000–0xFFFF	Select corresponding acceleration/deceleration time, and then convert 16-bit binary number into hexadecimal number, finally, and then set corresponding function codes. For details, see the following table.
P10.35	ACC/DEC time of steps 8–15 of simple PLC	0x0000		

The description is as follows:

Function code	Binary		Step	ACC/DEC time 1	ACC/DEC time 2	ACC/DEC time 3	ACC/DEC time 4
P10.34	BIT1	BIT0	0	00	01	10	11
	BIT3	BIT2	1	00	01	10	11
	BIT5	BIT4	2	00	01	10	11
	BIT7	BIT6	3	00	01	10	11
	BIT9	BIT8	4	00	01	10	11
	BIT11	BIT10	5	00	01	10	11
	BIT13	BIT12	6	00	01	10	11
	BIT15	BIT14	7	00	01	10	11
P10.35	BIT1	BIT0	8	00	01	10	11
	BIT3	BIT2	9	00	01	10	11
	BIT5	BIT4	10	00	01	10	11

Function code	Binary		Step	ACC/DEC time 1	ACC/DEC time 2	ACC/DEC time 3	ACC/DEC time 4
	BIT7	BIT6	11	00	01	10	11
	BIT9	BIT8	12	00	01	10	11
	BIT11	BIT10	13	00	01	10	11
	BIT13	BIT12	14	00	01	10	11
	BIT15	BIT14	15	00	01	10	11

6.4.2.5 Setting frequency through multi-step speed commands

You can set P00.06 or P00.07 to 6 (setting frequency through multi-step speed commands). It is applicable to scenarios where the VFD running frequency does not need to be adjusted continuously and only a number of frequency values are needed.

The VFD supports the setting of 16-step speed, which are set by combined codes of multi-step terminals 1–4 set by S terminals, corresponding to function code P05.01–P05.09) and correspond to multi-step speed 0 to multi-step speed 15.

When terminal 1, terminal 2, terminal 3, and terminal 4 are off, the frequency input method is specified by P00.06 or P00.07. When terminal 1, terminal 2, terminal 3, and terminal 4 are not all off, setting frequency through multi-step speed commands will prevail. That is, the priority of setting frequency through multi-step speed commands is higher than that of setting frequency through the keypad, analog, high-speed pulse, PID, and communication.

Note: The symbol of multi-step speed determines the running direction of simple PLC, and the negative value means reverse running. For details, see 6.4.2.4 Setting frequency through simple PLC.

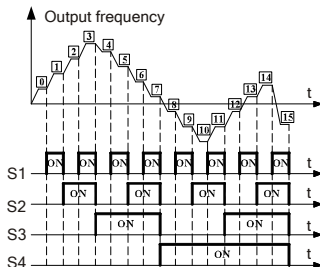

T1	OFF	ON	OFF	ON	OFF	ON	OFF	ON
T2	OFF	OFF	ON	ON	OFF	OFF	ON	ON
T3	OFF	OFF	OFF	OFF	ON	ON	ON	ON
T4	OFF	OFF	OFF	OFF	OFF	OFF	OFF	OFF
Step	0	1	2	3	4	5	6	7
T1	OFF	ON	OFF	ON	OFF	ON	OFF	ON
T2	OFF	OFF	ON	ON	OFF	OFF	ON	ON
T3	OFF	OFF	OFF	OFF	ON	ON	ON	ON
T4	ON	ON	ON	ON	ON	ON	ON	ON
Step	8	9	10	11	12	13	14	15

Function code	Name	Default	Setting range	Description
P05.01– P05.09	Function selection of multifunction digital input terminals (S1–S8, and HDIA)	1	0–95	16: Multi-step speed terminal 1
		4		17: Multi-step speed terminal 2
		7		18: Multi-step speed terminal 3
		0		19: Multi-step speed terminal 4
		0		20: Pause multi-step speed running
		0		
		0		
		0		
P10.02– P10.32	Multi-step speeds 0–15 and running time	0.0%	Frequency: -300.0–300.0%	The setting 100.0% corresponds to the max. output frequency (P00.03).
		0.0s(min)	Time: 0.0–6553.5s(min)	The time unit is specified by P10.37.

6.4.2.6 Setting frequency through PID control

You can set P00.06 or P00.07 to 7 (setting frequency through PID control).

PID control, a common mode for process control, is mainly used to adjust the VFD output frequency or output voltage, thus forming a negative feedback system to keep the controlled variables above the target. It is applicable to flow control, pressure control, temperature control, and so on. The following is the basic schematic block diagram for output frequency regulation.

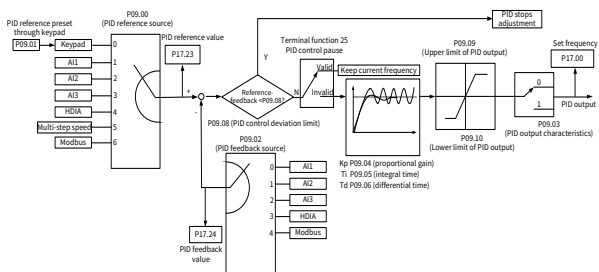

Function code	Name	Default	Setting range	Description
P09.00	PID reference source selection	0	0-6	<p>When P00.06 or P00.07 (Setting channel of A/B frequency command) is 7 or P04.27 (Voltage setting channel) is 6, the VFD is process PID controlled. The function code determines the target given channel during the PID process.</p> <p>0: Setting through P09.01 1: AI1 2: AI2 3: AI3 4: High-speed pulse HDIA 5: Multi-step running 6: Modbus communication</p> <p>The set target of process PID is a relative value, for which 100% equals 100% of the feedback signal of the controlled system. The system always calculates a related value (0-100.0%).</p>

Function code	Name	Default	Setting range	Description
P09.01	PID digital setting	0.0%	-100.0%–100.0%	The function code is mandatory when P09.00=0. The base value of P09.01 is the feedback of the system.
P09.02	PID feedback source selection	0	0–4	0: AI1 1: AI2 2: AI3 3: High-speed pulse HDIA 4: Modbus communication  Note: The reference channel and feedback channel cannot be duplicate. Otherwise, effective PID control cannot be achieved.
P09.03	PID output characteristics selection	0	0–1	0: PID output is positive. When the feedback signal is greater than the PID reference value, the output frequency of the VFD will decrease to balance the PID. Example: PID control on strain during unwinding. 1: PID output is negative. When the feedback signal is greater than the PID reference value, the output frequency of the VFD will increase to balance the PID. Example: PID control on strain during unwinding.
P09.07	Sampling cycle (T)	0.100s	0.000–1.000s	Used to indicate the sampling cycle of feedback. The regulator calculates in each sampling cycle. A longer sampling cycle indicates slower response.
P09.08	PID control	0.0%	0.0–100.0%	Used to adjust the accuracy

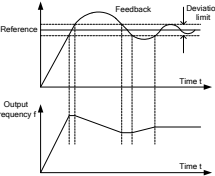
Function code	Name	Default	Setting range	Description
	deviation limit			<p>and stability of the PID system.</p> <p>The output value of the PID system is relative to the max. deviation of the closed loop reference. As shown in the following figure, the PID regulator stops regulating in the range of deviation limit.</p> 
P09.09	PID output upper limit	100.0%	P09.10–100.0% (Max. frequency or voltage)	Specifies the upper limit of PID regulator output values.
P09.10	PID output lower limit	0.0%	-100.0%– P09.09 (Max. frequency or voltage)	Specifies the lower limit of PID regulator output values.
P09.11	Feedback offline detection value	0.0%	0.0–100.0%	When the feedback value is smaller than or equal to the feedback offline detection value, and the duration exceeds the value specified by P09.12, the VFD reports "PID feedback offline fault" the keypad displays "E22".
P09.12	Feedback offline detection time	1.0s	0.0–3600.0s	

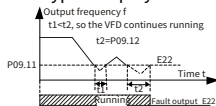

Function code	Name	Default	Setting range	Description
P09.13	PID control selection	0x0001	0x0000-0x1111	<p>Ones place: 0: Continue integral control after the frequency reaches upper/lower limit 1: Stop integral control after the frequency reaches upper/lower limit</p> <p>Tens place: 0: Same as the main reference direction 1: Contrary to the main reference direction</p> <p>Hundreds place: 0: Limit as per the max. frequency 1: Limit as per A frequency</p> <p>Thousands place: 0: A+B frequency. ACC/DEC of main reference A frequency source buffering is invalid. 1: A+B frequency. ACC/DEC of main reference A frequency source buffering is valid. ACC/DEC is determined by P08.04 (ACC time 4).</p>
P09.14	Low frequency proportional gain (Kp)	1.00	0.00-100.00	<p>Low-frequency switching point: 5.00Hz; high-frequency switching point: 10.00Hz (P09.04 corresponds to high-frequency parameter), and the middle is the linear interpolation between two points.</p>
P09.15	ACC/DEC time of PID command	0.0s	0.0-1000.0s	-

Function code	Name	Default	Setting range	Description
P09.16	PID output filter time	0.000s	0.000–10.000s	-
P09.18	Low frequency integral time (Ti)	0.90s	0.00–10.00s	-
P09.19	Low frequency differential time (Td)	0.00s	0.00–10.00s	-
P09.20	Low frequency point for PID parameter switching	5.00Hz	0.00Hz–P09.21	-
P09.21	High frequency point for PID parameter switching	10.00Hz	P09.20–P00.03	-
P17.00	Set frequency	0.00Hz	0.00Hz–P00.03 (Max. output frequency)	-
P17.23	PID reference value	0.0%	-100.0–100.0%	-
P17.24	PID feedback value	0.0%	-100.0–100.0%	-

■ Introduction to the working principles and control methods for PID control

Proportional regulation (Kp)

Proportional control can respond to feedback changes rapidly, however, it cannot eliminate the static difference by itself. A larger proportional gain indicates a faster regulating speed, but a too large gain will result in oscillation. To solve this problem, set the integral time to a large value and the differential time to 0 to run the system, and then change the reference to observe the difference (that is, static difference) between the feedback signal and reference. If the static difference occurs in the direction of reference change (such as reference increase, where the feedback is always less than the reference after system stabilizes), continue increasing the proportional gain; otherwise, decrease the proportional gain. Repeat this process until the static difference becomes small.

Function code	Name	Default	Setting range	Description
P09.04	Proportional gain (Kp)	1.80	0.00–100.00	The function is applied to the proportional gain P of PID input. P determines the strength of the whole PID regulator. The larger the value of P, the stronger the adjustment intensity. The value 100 indicates that when the difference between the PID feedback value and given value is 100%, the range within which the PID regulator can regulate the output frequency command is the max. frequency (ignoring integral function and differential function).

Integral time (Ti)

The integral adjuster can be used to eliminate static difference. Too large regulation may lead to system oscillation. The integral time parameter is generally regulated gradually from large to small until the stabilized system speed fulfills the requirement.

Function code	Name	Default	Setting range	Description
P09.05	Integral time (Ti)	0.90s	0.01–10.00s	Used to determine the speed of integral adjustment on the deviation of PID feedback and reference from the PID regulator. When the deviation is 100%, the integral regulator works continuously during the time to achieve the max. output frequency (P00.03) or the max. voltage (P04.31). Shorter integral time indicates stronger

Function code	Name	Default	Setting range	Description
				adjustment.

Differential time (Td)

Differential control is used to control the feedback signal variation based on the change trend. Exercise caution before using the differential regulator since it may enlarge the system interferences, especially those with high change frequency.

When P00.06 or P00.07 (Setting channel of A/B frequency command) is 7 or P04.27 (Voltage setting channel) is 6, the VFD is process PID controlled.

Function code	Name	Default	Setting range	Description
P09.06	Differential time (Td)	0.00s	0.00–10.00s	Used to determine the strength of the change ratio adjustment on the deviation of PID feedback and reference from the PID regulator. If the PID feedback changes 100% during the time, the adjustment of the differential regulator is the max. output frequency (P00.03) or the max. voltage (P04.31). Longer differential time indicates stronger adjustment.

■ How to fine-tune PID

After setting the parameters controlled by PID, you can adjust these parameters by the following means.

Control overshoot

When overshoot occurred, shorten the derivative time (Td) and prolong integral time (Ti).

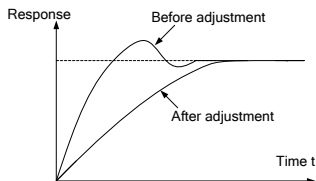

Stabilize the feedback value as fast as possible

When overshoot occurred, shorten integral time (T_i) and prolong derivative time (T_d) to stabilize control as fast as possible.

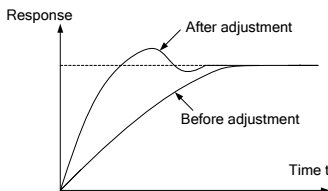

Control long-term oscillation

If the cycle of periodic oscillation is longer than the set value of integral time (T_i), it indicates the integral action is too strong, prolong the integral time (T_i) to control oscillation.

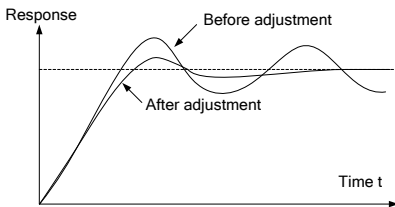

Control short-term oscillation

If the oscillation cycle is as short almost the same as the set value of differential time (T_d), it indicates the differential action is too strong. Shorten the differential time (T_d) to control oscillation. When the differential time (T_d) is set to 0.00 (namely no

differential control), and there is no way to control oscillation, decrease the proportional gain.

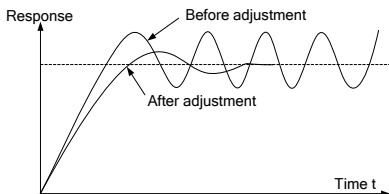

6.4.2.7 Frequency set through communication

You can set P00.06 or P00.07 to 8 (Setting frequency through communication). For details, see 7 Communication.

6.4.3 Frequency fine-tuning

The VFD supports frequency fine-tuning based on the set frequency. In some special scenarios, the set frequency can be set to 0, and the frequency fine-tuning function can be used for frequency setting during the whole process.

Step 1 Select any of multifunction digital input terminals S1–S8 and HDIA as an external input terminal.

Step 2 Set P05.01–P05.09 to 10 or 11.

Function code	Name	Default	Setting range	Description
P05.01–P05.09	Function selection of multifunction digital input terminals (S1–S8, and HDIA)	1	0–95	10: Increase frequency setting (UP) 11: Decrease frequency setting (DOWN)
		4		
		7		
		0		
		0		
		0		
		0		
		0		
P08.44	UP/DOWN terminal control	0x000	0x000–0x221	Ones place: Frequency setting selection 0: The setting made through

Function code	Name	Default	Setting range	Description
	setting			UP/DOWN is valid. 1: The setting made through UP/DOWN is invalid. Tens place: Frequency control selection 0: Valid only when P00.06=0 or P00.07=0 1: Valid for all frequency setting methods 2: Invalid for multi-step speed running when multi-step speed running has the priority Hundreds place: Action selection for stop 0: Setting is valid. 1: Valid during running, cleared after stop 2: Valid during running, cleared after a stop command is received
P08.45	Frequency increment change rate of the UP terminal	0.50Hz/s	0.01–50.00	-
P08.46	Frequency reduce rate of the DOWN terminal	0.50Hz/s	0.01–50.00	-

6.5 Speed control mode selection

The VFD supports three speed control modes. You can set P00.00 to select a speed control mode based on actual conditions. Before using a vector control mode (0 or 1), set the motor nameplate parameters and perform motor parameter autotuning first. For details, see 6.1.2 Rated motor parameter setting and 6.2 Motor parameter autotuning setting.

Function code	Name	Default	Setting range	Description
P00.00	Speed control mode	2	0–2	0: SVC 0 1: SVC 1 2: Space voltage vector control mode

SVC mode 0: P00.00 = 0

It is applicable to the scenarios where high control accuracy and fast response are required. For details, see Group P03—Vector control of motor 1.

Note: The SM in this mode is applicable to large-power low frequency running rather than ultra-high speed running.

SVC mode 1: P00.00 = 1

It is applicable to the scenarios where mediocre control accuracy and response speed are enough. For details, see Group P03—Vector control of motor 1.

Space voltage vector control mod: P00.00 = 2

It is applicable to the scenarios where mediocre control accuracy is enough and a VFD needs to drive multiple motors. For details, see Group P04—V/F control.

6.6 Torque setting method

The VFD supports torque control and speed control. Speed control aims to stabilize the speed to keep the set speed consistent with the actual running speed, meanwhile, the max. load-carrying capacity is restricted by the torque limit. Torque control aims to stabilize the torque to keep the set torque consistent with the actual output torque, meanwhile, the output frequency is restricted by the upper and lower limits.

6.6.1 Torque setting method selection

You can set P03.11 to select a torque setting method. The torque setting adopts a relative value, 100% corresponds to the motor rated current, and the setting range is -300.0%–300.0%. After giving the start command to the VFD, the VFD runs in the forward direction when the torque reference value is positive and in the reverse direction when the torque reference value is negative.

Function code	Name	Default	Setting range	Description
P03.11	Torque setting method	0	0–7	0–1: Keypad (P03.12) 2: AI1 3: AI2 4: AI3

Function code	Name	Default	Setting range	Description
				5: Pulse frequency HDIA 6: Multi-step torque 7: Modbus communication  Note: For AMs, 100% corresponds to the motor rated torque current (when the value 0 or 1 is selected) and 100% corresponds to triple the motor rated torque current (when the value from 2 to 7 is selected). For SMs, 100% corresponds to the motor rated current (when the value 0 or 1 is selected) and 100% corresponds to triple the motor rated current (when the value from 2 to 7 is selected).
P03.12	Torque set through keypad	20.0%	-300.0%–300.0%	The torque setting adopts a relative value. For AMs, 100% corresponds to the motor rated torque current; for SMs, 100% corresponds to the motor rated current.
P03.13	Torque reference filter time	0.010s	0.000–10.000s	-

6.6.2 Switching between speed control and torque control

There are two switching methods for speed control and torque control.

Method 1 Enable control switching

Set P03.32 to 0 for speed control or 1 for torque control.

Method 2 Switch through multifunction digital input terminal signal function selection

The multifunction digital input terminal signal switching procedure is as follows:

Step 1 Select any of multifunction digital input terminals S1–S8 and HDIA as an external input terminal.

Step 2 Set P05.01–P05.09 to 29.

When function 29 is valid, set P03.32 to 0 for torque control or 1 for speed control.

Note: When the terminal for switching speed control and torque control is valid, the control enabling selection is the opposite of that selected in P03.32.

Function code	Name	Default	Setting range	Description
P03.32	Enabling torque control	0	0–1	0: Disable 1: Enable
P05.01– P05.09	Function selection of multifunction digital input terminals (S1–S8, and HDIA)	1	0–95	29: Switch between speed control and torque control
		4		
		7		
		0		
		0		
		0		
		0		
		0		

6.7 Start/stop settings

6.7.1 Start settings

For a specific motor type and application scenario, you can select a start mode by setting P01.00.

Function code	Name	Default	Setting range	Description
P01.00	Start mode	0	0–1	0: Direct start 1: Start after DC braking

Direct start: P01.00= 0

If the braking time before start is 0, the VFD runs at the starting frequency of direct start P01.01. This is often applicable to start from a still state. See the following figure.

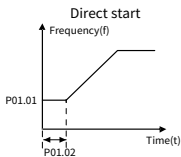

Start after DC braking: P01.00= 1

If the DC braking time is not 0, enable the motor to keep at a position by means of DC braking, and then perform ACC start. This is applicable to the scenarios with the motor in slight rotation before start. See the following figure.

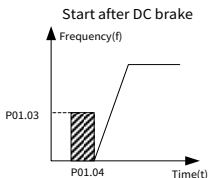

Function code	Name	Default	Setting range	Description
P01.01	Starting frequency of direct start	0.50Hz	0.00–50.00Hz	The function code indicates the initial frequency during VFD start. See P01.02 (Starting frequency hold time) for detailed information.
P01.02	Starting frequency hold time	0.0s	0.0–50.0s	Setting a proper starting frequency can increase the torque during VFD start. During the hold time of the starting frequency, the output frequency of the VFD is the starting frequency. And then, the VFD runs from the starting frequency to the set frequency. If the set frequency is lower than the

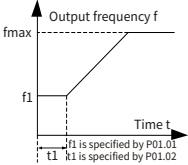
Function code	Name	Default	Setting range	Description
				<p>starting frequency, the VFD stops running and keeps in the standby state. The starting frequency is not limited in the lower limit frequency.</p>  <p>The graph shows the output frequency f over time t. It starts at a constant frequency f_1 for a duration t_1. After t_1, the frequency increases linearly until it reaches the maximum frequency f_{max}, where it then remains constant.</p> <p>f_1 is specified by P01.01 t_1 is specified by P01.02</p>
P01.03	Braking current before start	0.0%	0.0–100.0%	The VFD performs DC braking with the braking current before start and it speeds up after the DC braking time. If the set DC braking time is 0, DC braking is invalid.
P01.04	Braking time before start	0.00s	0.00–50.00s	Stronger braking current indicates larger braking power. The DC braking current before start is a percentage of the VFD rated output current.
P01.23	Start delay	0.0s	0.0–600.0s	After a VFD running command is given, the VFD is in standby state and restarts with the start delay to implement brake release.
P01.30	Hold time of short-circuit braking for start	0.00s	0.0–50.0s	When the VFD starts in direct start mode (P01.00=0), set P01.30 to a non-zero value to enter short-circuit braking.

6.7.2 Stop settings

You can select a stop mode by setting P01.08.

Function code	Name	Default	Setting range	Description
P01.08	Stop mode	0	0: Decelerate to stop 1: Coast to stop	-

Decelerate to stop: P01.08= 0

After a stop command takes effect, the VFD lowers output frequency based on the DEC mode and the defined DEC time; after the frequency drops to the stop speed (P01.15), the VFD stops.

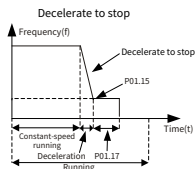

Coast to stop: P01.08= 1

After a stop command takes effect, the VFD stops output immediately, and the load coasts to stop according to mechanical inertia.

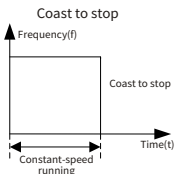

Note: If the set frequency is changed from higher than the frequency lower limit to lower than the frequency lower limit, the VFD takes the action specified by P01.19.

Function code	Name	Default	Setting range	Description
P01.19	Action selected when running frequency less than	0x00	0x00-0x12	Ones place: Action selection 0: Run at the frequency lower limit 1: Stop 2: Sleep Tens place: Stop mode

Function code	Name	Default	Setting range	Description
	frequency lower limit (valid when frequency lower limit greater than 0)			0: Coast to stop 1: Decelerate to stop

P01.09 = Non-zero value

Short-circuit braking for stop and DC braking can be valid only with this setting. During decelerating to stop, if the running frequency of VFD is lower than the starting frequency of brake for stop (P01.09), the VFD waits for the demagnetization time P01.10 and checks the value of P01.31. If the value is a non-zero value, the VFD enters short-circuit braking for stop. Then the VFD checks the value of P01.12. If the value is a non-zero value, the VFD performs DC braking with the time specified by P01.12. When the DC braking time is reached, the VFD coasts to stop. If the value of P01.31 is zero, short-circuit braking for stop is invalid. Similarly, if the value of P01.12 is zero, DC braking for stop is invalid.

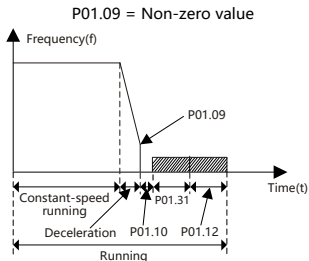

P01.09 = Zero

The VFD decelerates to stop according to the normal process. When the ramp frequency is less than P01.15, the VFD performs stop determination with a delay specified by P01.24 according to the mode specified by P01.16. If P01.16 = 0, the VFD coasts to stop. If P01.16 = 1, the VFD needs to check whether the motor output frequency is less than P01.15. If yes, the VFD coasts to stop. If no, the VFD coasts to stop with a delay specified by P01.17.

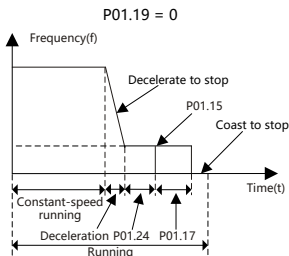

The methods for fast decelerating to stop are as follows:

Method 1 Increase the VFD power to improve the VFD max. braking capability.

Method 2 Decelerate to the lower speed specified by P01.09 to enable short-circuit braking or DC braking.

Method 3 Set P08.50 to enable magnetic flux braking.

Method 4 Add braking resistors.

Method 5 Set the S-curve deceleration method.

Function code	Name	Default	Setting range	Description
P01.09	Starting frequency of DC braking for stop	0.00Hz	0.00Hz–P00.03	P00.03 specifies the max. output frequency. During the deceleration to stop, the VFD starts DC braking for stop when the running frequency reaches the frequency specified by P01.09.
P01.10	Demagnetization time	0.00s	0.00–30.00s	The VFD blocks the output before starting DC braking for stop. The VFD starts DC braking after this time so as to prevent overcurrent caused by DC braking at high speed.
P01.11	DC braking	0.0%	0.0–100.0%	Percentage of the VFD rated

Function code	Name	Default	Setting range	Description
	current for stop			output current. Stronger current indicates greater DC braking effect.
P01.12	DC braking time for stop	0.00s	0.0–50.0s	DC braking duration. If the time is 0, DC braking is invalid, and the VFD decelerates to stop within the specified time.
P01.15	Stop speed	0.50Hz	0.00–100.00Hz	-
P01.16	Stop speed detection mode	0	0–1	0: Detect by the set speed (unique in space voltage vector control mode) 1: Detect by the feedback speed
P01.17	Stop speed detection time	0.50s	0.00–100.00s	-
P01.24	Stop speed delay	0.0s	0.0–600.0s	-
P01.29	Short-circuit braking current	0.0%	0.0–150.0%	of the VFD rated current
P01.31	Hold time of short-circuit braking for stop	0.00s	0.0–50.0s	-

6.7.3 Power-off restart

For any command running channels, if P01.21 = 1, the VFD memorizes the running status at power-off. If the VFD is running before power-off, the VFD automatically runs with a wait time specified by P01.22 at the next power-on when start conditions are met.

When terminals are used as the command running channel, you need to set P01.18 to 1. The following figure shows the wait time for restart after power-off.

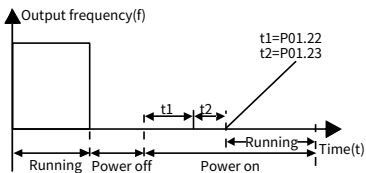

The following figure shows the logic diagram for restart after power-off:

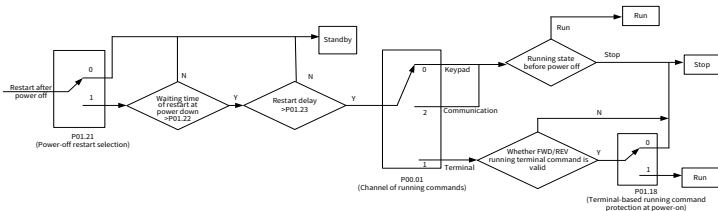

Function code	Name	Default	Setting range	Description
P01.21	Restart after power off	0	0-1	0: Disable 1: Enable
P01.22	Wait time for restart after power-off	1.0s	0.0-3600.0s	Valid when P01.21 is 1. The function code indicates the wait time before the automatic running of the VFD that is re-powered on.
P01.23	Start delay	0.0s	0.0-600.0s	After a VFD running command is given, the VFD restarts running output with the delay defined by P01.23 from the standby state, to implement brake release.
P01.18	Terminal-based running	0	0-1	0: The terminal running command is invalid at power-on.

Function code	Name	Default	Setting range	Description
	command protection at power-on			1: The terminal running command is valid at power-on. Note: Exercise caution before using this function. Otherwise, serious consequences may result.

Terminal-based running command is invalid at power-on: P01.18 = 0

Though the command running terminal is considered as valid during power-on, the VFD does not run and it keeps the protection state until the terminal is disabled and then enabled.

Terminal-based running command is valid at power-on: P01.18 = 1

If the command running terminal is considered as valid during power-on, the VFD is started automatically after the initialization.

6.8 Control performance regulation

6.8.1 Space vector control performance optimization

6.8.1.1 V/F curve setting

The VFD provides multiple V/F curve modes to meet different requirements. You can select V/F curves or set V/F curves as required.

For the load featuring constant torque, such as conveyor belt which runs in straight line, as the whole running process requires constant torque, it is recommended to adopt the straight line V/F curve.

For the load featuring decreasing torque, such as fan and water pumps, as there is a power (square or cube) relationship between its actual torque and speed, it is recommended to adopt the V/F curve corresponding to the power of 1.3, 1.7 or 2.0.

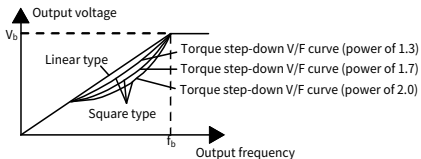

Note: In the figure, V_b indicates the motor rated voltage and f_b indicates the motor rated frequency.

Function code	Name	Default	Setting range	Description
P04.00	V/F curve setting of motor 1	0	0-5	0: Straight-line V/F curve, applicable to constant torque loads 1: Multi-point V/F curve 2: Torque-down V/F curve (power of 1.3) 3: Torque-down V/F curve (power of 1.7) 4: Torque-down V/F curve (power of 2.0) 5: Customized V/F (V/F separation); in this mode, V can be separated from F and F can be adjusted through the frequency setting channel set by P00.06 or the voltage setting channel set by P04.27 to change the characteristics of the curve.

The VFD also provides multi-point V/F curves. You can change the VFD output V/F curves by setting the voltage and frequency of the three points in the middle. A whole curve consists of five points starting from (0Hz, 0V) and ending at (motor fundamental frequency, motor rated voltage). During setting, follow the rule: $0 \leq f_1 \leq f_2 \leq f_3 \leq$ Motor fundamental frequency, and $0 \leq V_1 \leq V_2 \leq V_3 \leq$ Motor rated voltage. Too high voltage for low frequency will cause motor overheat or damage and cause VFD overcurrent stall or overcurrent protection. When P04.00 is set to 1 (multi-dot V/F curve), you can set the V/F curve through P04.03–P04.08.

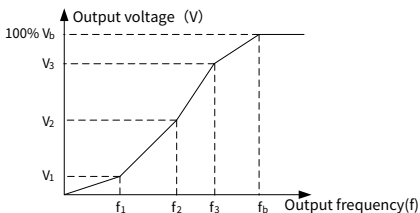

Function code	Name	Default	Setting range	Description
P04.03	V/F frequency point 1 of motor 1	0.00Hz	0.00Hz~P04.05	-
P04.04	V/F voltage point 1 of motor 1	0.0%	0.0%~110.0%	Rated voltage of motor 1
P04.05	V/F frequency point 2 of motor 1	0.00Hz	P04.03~P04.07	-
P04.06	V/F voltage point 2 of motor 1	0.0%	0.0%~110.0%	Rated voltage of motor 1
P04.07	V/F frequency point 3 of motor 1	0.00Hz	P04.05~P02.02 (Rated frequency of AM 1) or P04.05~P02.16 (Rated frequency of SM 1)	-
P04.08	V/F voltage point 3 of motor 1	0.0%	0.0%~110.0%	Rated voltage of motor 1

6.8.1.2 Torque boost

Boost compensation to output voltage can effectively improve the low-speed torque performance in the V/F control. The cut-off frequency of manual torque boost is a percentage of the rated motor frequency f_b . Torque boost can improve the low-frequency torque characteristics in the V/F control.

You need to select torque boost based on the load. The load is proportional to the boost, but the boost cannot be too large. If the torque boost is too large, the motor will run at over-excitation, which may cause increased output current and motor overheating, thus decreasing the efficiency. The default torque boost is 0.0%, which indicates automatic torque boost so that the VFD can regulate the torque boost based on the actual load.

Set P04.01 to determine the torque boost of motor 1. Set P04.02 to determine the torque boost cut-off frequency of motor 1. Below this frequency threshold, torque boost is valid; exceeding this threshold will invalidate torque boost. See the following figure.

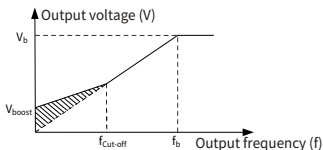

Function code	Name	Default	Setting range	Description
P04.01	Torque boost of motor 1	0.0%	0.0%–10.0%	0.0% (automatic torque boost); 0.1%–10.0% (manual torque boost) Note: V_b indicates the max. output voltage.
P04.02	Torque boost cut-off frequency of motor 1	20.0%	0.0%–50.0%	The cut-off frequency of manual torque boost is a percentage of the rated motor frequency f_b . Torque boost can improve the low-frequency torque characteristics in the V/F control.

6.8.1.3 V/F slip compensation gain

The V/F control is an open-loop mode, while a sudden motor load change will cause motor rotation speed fluctuation. In cases where strict speed requirements must be met, you can set the slip compensation gain through P04.09 to change the VFD internal output adjustment method and therefore compensate for the speed change caused by load fluctuation, improving the motor mechanical rigidity.

The formula used to calculate the motor rated slip frequency is as follows:
 $\Delta f = f_b - n \cdot p / 60$

Of which, f_b indicates the rated frequency of motor 1, corresponding to function code P02.02; n indicates the rated rotation speed of motor 1, corresponding to function code P02.03; p indicates the number of motor pole pairs. 100.0%

corresponds to the rated slip frequency Δf of motor 1.

Function code	Name	Default	Setting range	Description
P04.09	V/F slip compensation gain of motor 1	100.0%	0.0–200.0%	100% corresponds to the rated slip frequency.

Note: Rated slip frequency = (Rated synchronous rotation speed of motor – Rated rotation speed of motor) x (Number of motor pole pairs)/60

6.8.1.4 Oscillation control

In large-power driving scenarios, using the space voltage vector control mode will cause motor oscillation, which can be eliminated by setting P04.10 and P04.11, while the oscillation control threshold of motor 1 is specified by P04.12.

Function code	Name	Default	Setting range	Description
P04.10	Low-frequency oscillation control factor of motor 1	10	0–100	Setting a greater value indicates better control effect. However, if the value is too large, the VFD output current may be too large.
P04.11	High-frequency oscillation control factor of motor 1	10	0–100	
P04.12	Oscillation control threshold of motor 1	30.00Hz	0.00Hz–P00.03	

6.8.1.5 Reactive current regulation in SM V/F control

When the SM V/F control mode is enabled, you can set P04.36 to specify the frequency threshold for the switching between pull-in current 1 and pull-in current 2. When the output frequency is less than P04.36, the motor reactive current is specified by P04.34; when the output frequency is greater than P04.36, the motor reactive current is specified by P04.35.

Function code	Name	Default	Setting range	Description
P04.34	Pull-in current 1 in SM V/F control	20.0%	-100.0%–100.0%	-
P04.35	Pull-in current 2 in SM V/F control	10.0%	-100.0%–100.0%	-
P04.36	Frequency threshold for pull-in current switching in SM V/F control	20.0%	0.0%–200.0%	-
P04.37	Reactive current closed-loop proportional coefficient in SM V/F control	50	0–3000	When the SM V/F control mode is enabled, the function code is used to set the proportional coefficient of reactive current closed-loop control.
P04.38	Reactive current closed-loop integral time in SM V/F control	30	0–3000	When the SM V/F control mode is enabled, the function code is used to set the integral coefficient of reactive current closed-loop control.

6.8.1.6 V/F flux weakening performance optimization

When the AM needs to run with flux weakened, set P04.33 in the V/F control mode to increase the output voltage and maximize the bus voltage utilization, improving the motor acceleration time.

Function code	Name	Default	Setting range	Description
P04.33	Weakening coefficient	1.00	1.00–1.30	-

Function code	Name	Default	Setting range	Description
	in constant power zone			

6.8.2 Vector control performance optimization

6.8.2.1 Torque upper limit

Speed control and torque control in the vector control mode are restricted by torque upper limits. When you set P03.18 (Setting source of electromotive torque upper limit) to keypad, the torque upper limit is specified by P03.20. When you set P03.19 (Setting source of braking torque upper limit) to keypad, the torque upper limit is specified by P03.21.

Function code	Name	Default	Setting range	Description
P03.18	Setting source of electromotive torque upper limit	0	0–5	0: Keypad (P03.20) 1: AI1 2: AI2 3: AI3 4: Pulse frequency HDIA 5: Modbus communication Note: For AMs, 100% corresponds to the motor rated torque current (when the value 0 is selected) and 100% corresponds to triple the motor rated torque current (when the value from 1 to 5 is selected). For SMs, 100% corresponds to the motor rated current (when the value 0 or 1 is selected) and 100% corresponds to triple the motor rated current (when the value from 2 to 5 is selected).
P03.19	Setting source of braking	0	0–5	0: Keypad (P03.21) 1: AI1 2: AI2

Function code	Name	Default	Setting range	Description
	torque upper limit			3: AI3 4: Pulse frequency HDIA 5: Modbus communication Note: For AMs, 100% corresponds to the motor rated torque current (when the value 0 is selected) and 100% corresponds to triple the motor rated torque current (when the value from 1 to 5 is selected). For SMs, 100% corresponds to the motor rated current (when the value 0 is selected) and 100% corresponds to triple the motor rated current (when the value from 1 to 5 is selected).
P03.20	Electromotive torque upper limit set through keypad	180.0%	0.0–300.0%	Specifies torque limits. For AMs, 100% corresponds to the motor rated torque current; for SMs, 100% corresponds to the motor rated current.
P03.21	Braking torque upper limit set through keypad	180.0%	0.0–300.0%	

6.8.2.2 Frequency upper limit settings in torque control

In torque control, the VFD outputs torque according to the set torque command. When the set torque is greater than the load torque, the VFD output frequency increases to the frequency upper limit; when the set torque is less than the load torque, the VFD output frequency decreases to the frequency lower limit; when the VFD output frequency is restricted, the output torque will no longer be the same as the set torque. When you set P03.14 to set the setting source of forward rotation

upper-limit frequency in torque control, the torque limit is specified by P03.16. When you set P03.15 to set the setting source of reverse rotation upper-limit frequency in torque control, the torque limit is specified by P03.17.

Function code	Name	Default	Setting range	Description
P03.14	Setting source of forward rotation upper-limit frequency in torque control	0	0–6	0: Keypad (P03.16) 1: AI1 2: AI2 3: AI3 4: Pulse frequency HDIA 5: Multi-step setting 6: Modbus communication Note: For setting sources 1–11, 100% corresponds to the max. frequency.
P03.15	Setting source of reverse rotation upper-limit frequency in torque control	0	0–6	0: Keypad (P03.17) 1: AI1 2: AI2 3: AI3 4: Pulse frequency HDIA 5: Multi-step setting 6: Modbus communication Specifies frequency upper limits. 100% corresponds to the max. frequency. P03.16 specifies the value when P03.14 = 1, while P03.17 specifies the value when P03.15 = 1.
P03.16	Forward rotation frequency upper limit set through keypad in torque control	50.00Hz	0.00Hz– P00.03 (Max. output frequency)	Specifies frequency upper limits. 100% corresponds to the max. frequency. P03.16 specifies the value when P03.14 = 1, while P03.17 specifies the value when P03.15 = 1.
P03.17	Reverse rotation			

Function code	Name	Default	Setting range	Description
	upper-limit frequency set through keypad in torque control			

6.8.2.3 Speed loop

The speed loop dynamic response characteristics in vector control can be adjusted by setting the proportional coefficient and integral time of speed regulator.

The dynamic response of speed regulator can be accelerated by increasing the proportional gain or decreasing the integral time. However, too quick dynamic response of speed regulator can cause oscillations.

Recommended adjustment method: If the default settings cannot meet the requirements, adjust the settings slightly. First, increase the proportional gain to ensure that the system does not oscillate; and then reduce the integration time, so that the system responds fast with small overshoot.

Improper PI parameter settings will cause large speed overshoot.

The switchover between the low-point frequency for switching and the high-point frequency for switching indicates the linear switchover between two groups of PI parameters. See the following figure.

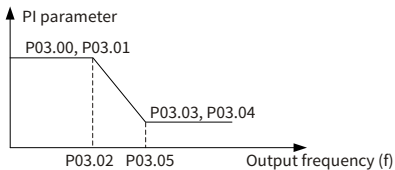

Function code	Name	Default	Setting range	Description
P03.00	Speed-loop proportional gain 1	20.0	0.0–200.0	Speed regulator PI parameters are divided into the low-speed group and high-speed group. When the running frequency is less
P03.01	Speed-loop integral time 1	0.200s	0.000–10.000s	

Function code	Name	Default	Setting range	Description
P03.02	Low-point frequency for switching	5.00Hz	0.00Hz–P03.05	than P03.02, the speed regulator PI parameters are P03.00 and P03.01. When the running frequency is greater than P03.05 (High-point frequency for switching), the speed regulator PI parameters are P03.03 and P03.04.
P03.03	Speed-loop proportional gain 2	20.0	0.0–200.0	
P03.04	Speed-loop integral time 2	0.200s	0.000–10.000s	-
P03.05	High-point frequency for switching	10.00Hz	P03.02–P00.03	-
P03.06	Speed-loop output filter	0	0–8	-
P03.36	Speed-loop differential gain	0.00s	0.00–10.00s	-

6.8.2.4 Current loop

Generally, there is no need to adjust it. If the current waveform is not sinusoidal, the current loop band width can be reduced.

Function code	Name	Default	Setting range	Description
P03.10	Current-loop band width	400	0–2000	-

6.8.2.5 Vector control flux weakening performance optimization

When running at a speed higher than the rated speed, the AM enters the flux weakening state. You can set P03.22 to change the flux-weakening curvature. A great flux-weakening control coefficient indicates a steep curve. The weakening coefficient in constant power zone is used in AM flux-weakening control, while the flux-weakening proportional gain and flux-weakening integral gain are specified by

P03.26 and P03.33. The max. VFD output voltage is specified by P03.24.

If pre-exciting is performed for the motor when the VFD starts up, a magnetic field is built up inside the motor to improve the torque performance during the start process. The pre-exciting time is specified by P03.25.

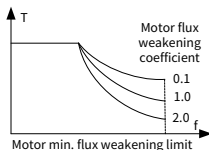

Function code	Name	Default	Setting range	Description
P03.23	Lowest weakening point in constant power zone	5%	10%–100%	Used when the AM is in flux-weakening control; the lowest weakening point in constant power zone is specified by P03.23.
P03.24	Max. voltage limit	100.0%	0.0–120.0%	Specifies the max. VFD output voltage, which is a percentage of the motor rated voltage. Set the value according to onsite conditions.
P03.25	Pre-exciting time	0.300s	0.000–10.000s	Pre-exciting is performed for the motor when the VFD starts up. A magnetic field is built up inside the motor to improve the torque performance during the start process.
P03.26	Flux-weakening proportional gain	1000	0–8000	-
P03.33	Flux-weakening integral gain	30.0%	0.0–300.0%	-

6.8.2.6 SM start control optimization

In the open-loop control mode, you can select a start control method by setting P13.01.

Function code	Name	Default	Setting range	Description
P13.01	Detection mode of initial pole	2	0: No detection 1: Reserved 2: Pulse superposition	-

No detection: P13.01 = 0

The VFD startup command given is a direct startup command. In this mode, set P13.02 to a great value to increase the starting torque, which causes a start reversal phenomenon with an average load carrying capacity.

Reserved: P13.01 = 1

Pulse superimposition: P13.01 = 2

This method is similar to that when P13.01 = 1. The difference is that the initial pole angle autotuning method is different. This method has higher identification accuracy with shorter time but sharper noise, but you can adjust the pulse current value by setting P13.06.

Function code	Name	Default	Setting range	Description
P13.02	Pull-in current 1	30.0%	0.0%–100.0% (of the motor rated current)	Pull-in current is the pole position orientation current; pull-in current 1 is valid within the lower limit of pull-in current switch-over frequency threshold. If you need to increase the start torque, increase the value of this function parameter properly.
P13.03	Pull-in current 2	0.0%	-100.0%–100.0% (of the motor rated current)	Specifies the pole position orientation current. It is valid within the upper limit of pull-in current switch-over frequency threshold. You do

Function code	Name	Default	Setting range	Description
				not need to change the value in most cases.
P13.04	Switch-over frequency of pull-in current	20.0%	0.0–200.0%	of the motor rated frequency
P13.06	Pulse current setting	80.0%	0.0–300.0% (of the motor rated voltage)	Specifies the pulse current threshold when the initial magnetic pole position is detected in the pulse mode.

6.9 Input and output

6.9.1 Digital input and output

6.9.1.1 Digital input

The VFD carries four programmable digital input terminals and one HDI input terminal. The functions of all the digital input terminals can be programmed through function codes. The HDI input terminal can be set to act as a high-speed pulse input terminal or common digital input terminal; if it is set to act as a high-speed pulse input terminal, you can also set HDIA high-speed pulse input to serve as the frequency reference input.

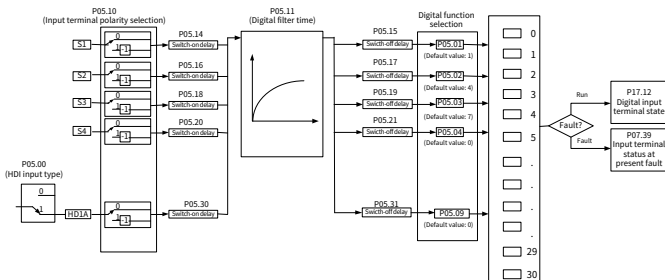

Note: Two different multifunction input terminals cannot be configured with a same function.

P05.01–P05.09 are used to set the functions of digital multifunction input terminals. Terminal functions are set as follows.

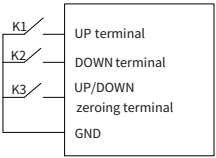
Setting	Function	Description
0	No function	The VFD does not act even if there is signal input. Set unused terminals to "no function" to avoid misaction.
1	Run forward (FWD)	External terminals are used to control the forward/reverse running of the VFD.
2	Run reversely (REV)	
3	Three-wire running control (SIN)	The terminal is used to determine the three-wire running control of the VFD. For details, see the description for P05.13.
4	Jog forward	For details about frequency of jogging running and ACC/DEC time of jogging running, see the description for P08.06, P08.07, and P08.08.
5	Jog reversely	
6	Coast to stop	The VFD blocks output, and the stop process of motor is uncontrolled by the VFD. This mode is applied in the scenarios with large-inertia loads and without stop time requirements. Its definition is the same as P01.08, and it is mainly used in remote control.
7	Fault reset	External fault reset function, same as the reset function of the STOP/RST key on the keypad. You can use this function to reset faults remotely.
8	Pause running	The VFD decelerates to stop, however, all the run parameters are in memory state, such as PLC parameter, wobbling frequency, and PID parameter. After this signal disappears, the VFD will revert to the state before stop.
9	External fault input	When external fault signal is transmitted to the VFD, the VFD releases fault alarm and stops.
10	Increase frequency setting (UP)	 <p>The terminal used to clear</p>
11	Decrease frequency setting (DOWN)	
12	Clear the frequency increase/decrease setting	

Setting	Function	Description																				
		frequency-increase/decrease setting can clear the frequency value of auxiliary channel set by UP/DOWN , thus restoring the reference frequency to the frequency given by main reference frequency command channel.																				
13	Switch between A setting and B setting	The function is used to switch between the frequency setting channels.																				
14	Switch between combination setting and A setting	Function 13 can implement the switchover between A frequency reference channel and B frequency reference channel; function 14 can implement the switchover between the combination channel set by P00.09 and the A frequency reference channel;																				
15	Switch between combination setting and B setting	function 15 can implement the switchover between the combination channel set by P00.09 and the B frequency reference channel.																				
16	Multi-step speed terminal 1	<p>A total of 16-step speeds can be set by combining digital states of these four terminals.</p> <p> Note: Multi-step speed 1 is the LSB, and multi-step speed 4 is the MSB.</p> <table border="1"> <thead> <tr> <th>Multi-step speed 4</th> <th>Multi-step speed 3</th> <th>Multi-step speed 2</th> <th>Multi-step speed 1</th> </tr> </thead> <tbody> <tr> <td>BIT3</td> <td>BIT2</td> <td>BIT1</td> <td>BIT0</td> </tr> </tbody> </table>	Multi-step speed 4	Multi-step speed 3	Multi-step speed 2	Multi-step speed 1	BIT3	BIT2	BIT1	BIT0												
Multi-step speed 4	Multi-step speed 3		Multi-step speed 2	Multi-step speed 1																		
BIT3	BIT2		BIT1	BIT0																		
17	Multi-step speed terminal 2																					
18	Multi-step speed terminal 3																					
19	Multi-step speed terminal 4																					
20	Pause multi-step speed running	The multi-step speed selection function can be screened to keep the set value in the present state.																				
21	ACC/DEC time selection 1	The status of the two terminals can be combined to select four groups of ACC/DEC time.																				
22	ACC/DEC time selection 2	<table border="1"> <thead> <tr> <th>T1</th> <th>T2</th> <th>ACC/DEC time</th> <th>Parameter</th> </tr> </thead> <tbody> <tr> <td>OFF</td> <td>OFF</td> <td>ACC/DEC time 1</td> <td>P00.11/P00.12</td> </tr> <tr> <td>ON</td> <td>OFF</td> <td>ACC/DEC time 2</td> <td>P08.00/P08.01</td> </tr> <tr> <td>OFF</td> <td>ON</td> <td>ACC/DEC time 3</td> <td>P08.02/P08.03</td> </tr> <tr> <td>ON</td> <td>ON</td> <td>ACC/DEC time 4</td> <td>P08.04/P08.05</td> </tr> </tbody> </table>	T1	T2	ACC/DEC time	Parameter	OFF	OFF	ACC/DEC time 1	P00.11/P00.12	ON	OFF	ACC/DEC time 2	P08.00/P08.01	OFF	ON	ACC/DEC time 3	P08.02/P08.03	ON	ON	ACC/DEC time 4	P08.04/P08.05
T1	T2	ACC/DEC time	Parameter																			
OFF	OFF	ACC/DEC time 1	P00.11/P00.12																			
ON	OFF	ACC/DEC time 2	P08.00/P08.01																			
OFF	ON	ACC/DEC time 3	P08.02/P08.03																			
ON	ON	ACC/DEC time 4	P08.04/P08.05																			
23	Simple PLC stop reset	Used to clear the previous PLC state memory information and restart the simple PLC process.																				
24	Pause simple PLC	Used to pause the simple PLC. When the function is revoked, the simple PLC resumes the running.																				
25	Pause PID control	PID is ineffective temporarily, and the VFD maintains current frequency output.																				

Setting	Function	Description
26	Pause wobbling frequency (stop at current frequency)	The VFD pauses at current output. After this function is canceled, it continues wobbling-frequency operation at current frequency.
27	Reset wobbling frequency (back to center frequency)	The set frequency of VFD reverts to center frequency.
28	Reset the counter	The counter is cleared.
29	Switch between speed control and torque control	The VFD switches from torque control mode to speed control mode, or vice versa.
30	Disable ACC/DEC	Used to ensure the VFD is not impacted by external signals (except for stop command), and maintains the present output frequency.
31	Trigger the counter	Used to enable the counter to count pulses.
33	Clear the frequency increase/decrease setting temporarily	When the terminal is closed, the frequency value set by UP/DOWN can be cleared to restore the reference frequency to the frequency given by frequency command channel; when the terminal is opened, it restores to the frequency value after frequency increase/decrease setting.
34	DC braking	The VFD starts DC brake immediately after the command becomes valid.
36	Switch the running command channel to keypad	When the function is enabled, the running command channel is switched to keypad. When the function is disabled, the running command channel is restored to the previous setting.
37	Switch the running command channel to terminal	When the function is enabled, the running command channel is switched to terminal. When the function is disabled, the running command channel is restored to the previous setting.
38	Switch the running command channel to communication	When the function is enabled, the running command channel is switched to communication. When the function is disabled, the running command channel is restored to the previous setting.
39	Pre-exciting command	When the function is enabled, motor pre-exciting is started until the function becomes invalid.
40	Clear power consumption	After this command becomes valid, the power consumption quantity of the VFD will be zeroed out.

Setting	Function	Description
	quantity	
41	Keep power consumption quantity	When the function is enabled, the present operation of the VFD does not impact the power consumption quantity.
42	Switch the setting source of braking torque upper limit to keypad	The torque upper limit is set through the keypad when the command is valid.
61	Switch PID polarities	Used to switch the PID output polarity. It is used together with P09.03.

Related parameters are listed in the following.

Function code	Name	Default	Setting range	Description
P05.00	HDI input type	0	0-1	0: HDIA is high-speed pulse input 1: HDIA is digital input
P05.01	S1 function selection	1	0-95	For details, see the preceding table. S1-S4 and HDIA are the terminals on the control board, while S5-S8 are achieved through the virtual terminal functions set by P05.12.
P05.02	S2 function selection	4		
P05.03	S3 function selection	7		
P05.04	S4 function selection	0		
P05.05	S5 function selection	0		
P05.06	S6 function selection	0		
P05.07	S7 function selection	0		
P05.08	S8 function selection	0		
P05.09	Function of HDIA	0		
P05.10	Input terminal polarity	0x000		

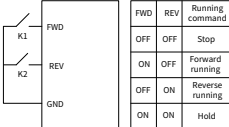
Function code	Name	Default	Setting range	Description															
				When a bit is 1, the input terminal is negative.															
P05.11	Digital filter time	0.010	0.000–50.000s	Used to specify the sampling filter time of the S1–S8 and HDIA terminals. In strong interference cases, increase the value to avoid maloperation.															
P05.12	Virtual terminal setting	0x000	0x000–0x1FF	Bit 0: S1 virtual terminal Bit 1: S2 virtual terminal Bit 2: S3 virtual terminal Bit 3: S4 virtual terminal Bit 4: S5 virtual terminal Bit 5: S6 virtual terminal Bit 6: S7 virtual terminal Bit 7: S8 virtual terminal Bit 8: HDIA virtual terminal															
P05.13	Terminal control mode	0	0–3	<p>Specifies the terminal control mode. 0: Two-wire control 1, the enabling consistent with the direction. This mode is widely used. The defined FWD/REV terminal command determines the motor rotation direction.</p>  <table border="1" data-bbox="764 939 896 1103"> <thead> <tr> <th>FWD</th> <th>REV</th> <th>Running command</th> </tr> </thead> <tbody> <tr> <td>OFF</td> <td>OFF</td> <td>Stop</td> </tr> <tr> <td>ON</td> <td>OFF</td> <td>Forward running</td> </tr> <tr> <td>OFF</td> <td>ON</td> <td>Reverse running</td> </tr> <tr> <td>ON</td> <td>ON</td> <td>Hold</td> </tr> </tbody> </table> <p>1: Two-wire control 2, the enabling separated from the direction. In this mode, FWD is the enabling terminal. The direction depends on the defined REV state.</p>	FWD	REV	Running command	OFF	OFF	Stop	ON	OFF	Forward running	OFF	ON	Reverse running	ON	ON	Hold
FWD	REV	Running command																	
OFF	OFF	Stop																	
ON	OFF	Forward running																	
OFF	ON	Reverse running																	
ON	ON	Hold																	
P05.14	S1 switch-on delay	0.000	0.000–50.000s																
P05.15	S1 switch-off delay	0.000																	
P05.16	S2 switch-on delay	0.000																	
P05.17	S2 switch-off delay	0.000																	
P05.18	S3 switch-on delay	0.000																	
P05.19	S3 switch-off delay	0.000																	
P05.20	S4 switch-on delay	0.000																	
P05.21	S4 switch-off delay	0.000																	
P05.22	S5 switch-on delay	0.000																	
P05.23	S5 switch-off	0.000																	

Function code	Name	Default	Setting range	Description																																							
	delay			<div data-bbox="598 171 905 336" data-label="Diagram"> <table border="1" data-bbox="767 171 905 336"> <thead> <tr> <th>FWD</th> <th>REV</th> <th>Running command</th> </tr> </thead> <tbody> <tr> <td>OFF</td> <td>OFF</td> <td>Stop</td> </tr> <tr> <td>ON</td> <td>OFF</td> <td>Forward running</td> </tr> <tr> <td>OFF</td> <td>ON</td> <td>Stop</td> </tr> <tr> <td>ON</td> <td>ON</td> <td>Reverse running</td> </tr> </tbody> </table> </div> <p>2: Three-wire control 1. This mode defines Sin as the enabling terminal, and the running command is generated by FWD, while the direction is controlled by REV. During running, the Sin terminal needs to be closed, and terminal FWD generates a rising edge signal, then the VFD starts to run in the direction set by the state of terminal REV; the VFD needs to be stopped by disconnecting terminal Sin.</p> <div data-bbox="598 744 809 950" data-label="Diagram"> </div> <p>The direction control is as follows during running:</p> <table border="1" data-bbox="603 1016 951 1278"> <thead> <tr> <th>Sin</th> <th>REV</th> <th>Previous direction</th> <th>Present direction</th> </tr> </thead> <tbody> <tr> <td rowspan="2">ON</td> <td>OFF→</td> <td>FWD run</td> <td>REV run</td> </tr> <tr> <td>ON</td> <td>REV run</td> <td>FWD run</td> </tr> <tr> <td rowspan="2">ON</td> <td>ON→</td> <td>REV run</td> <td>FWD run</td> </tr> <tr> <td>OFF</td> <td>FWD run</td> <td>REV run</td> </tr> <tr> <td>ON→</td> <td>ON</td> <td colspan="2" rowspan="2">Decelerate to stop</td> </tr> <tr> <td>OFF</td> <td>OFF</td> </tr> </tbody> </table> <p>Sin: Three-wire control; FWD: Forward running; REV: Reverse</p>	FWD	REV	Running command	OFF	OFF	Stop	ON	OFF	Forward running	OFF	ON	Stop	ON	ON	Reverse running	Sin	REV	Previous direction	Present direction	ON	OFF→	FWD run	REV run	ON	REV run	FWD run	ON	ON→	REV run	FWD run	OFF	FWD run	REV run	ON→	ON	Decelerate to stop		OFF	OFF
FWD	REV	Running command																																									
OFF	OFF	Stop																																									
ON	OFF	Forward running																																									
OFF	ON	Stop																																									
ON	ON	Reverse running																																									
Sin	REV	Previous direction	Present direction																																								
ON	OFF→	FWD run	REV run																																								
	ON	REV run	FWD run																																								
ON	ON→	REV run	FWD run																																								
	OFF	FWD run	REV run																																								
ON→	ON	Decelerate to stop																																									
OFF	OFF																																										

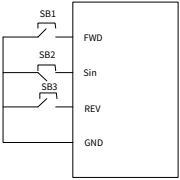
Function code	Name	Default	Setting range	Description																									
				<p>running</p> <p>3: Three-wire control 2. This mode defines Sin as the enabling terminal, and the running command is generated by FWD or REV, but the direction is controlled by both FWD and REV. During running, the Sin terminal needs to be closed, and terminal FWD or REV generates a rising edge signal to control the running and direction of the VFD; the VFD needs to be stopped by disconnecting terminal Sin.</p>  <table border="1" data-bbox="619 870 937 1255"> <thead> <tr> <th>Sin</th> <th>FWD</th> <th>REV</th> <th>Running direction</th> </tr> </thead> <tbody> <tr> <td rowspan="2">ON</td> <td>OFF→</td> <td>ON</td> <td>Forward running</td> </tr> <tr> <td>ON</td> <td>OFF</td> <td>Forward running</td> </tr> <tr> <td rowspan="2">ON</td> <td>ON</td> <td>OFF→</td> <td>Reverse running</td> </tr> <tr> <td>OFF</td> <td>ON</td> <td>Reverse running</td> </tr> <tr> <td>ON→</td> <td></td> <td></td> <td rowspan="2">Decelerate to stop</td> </tr> <tr> <td>OFF</td> <td></td> <td></td> </tr> </tbody> </table> <p>Sin: Three-wire control; FWD: Forward running; REV: Reverse</p>	Sin	FWD	REV	Running direction	ON	OFF→	ON	Forward running	ON	OFF	Forward running	ON	ON	OFF→	Reverse running	OFF	ON	Reverse running	ON→			Decelerate to stop	OFF		
Sin	FWD	REV	Running direction																										
ON	OFF→	ON	Forward running																										
	ON	OFF	Forward running																										
ON	ON	OFF→	Reverse running																										
	OFF	ON	Reverse running																										
ON→			Decelerate to stop																										
OFF																													

Function code	Name	Default	Setting range	Description
				<p>running</p> <p>Note: For two-wire controlled running mode, when the FWD/REV terminal is valid, if the VFD stops due to a stop command given by another source, the VFD does not run again after the stop command disappears even if the control terminal FWD/REV is still valid. To make the VFD run, you need to trigger FWD/REV again, for example, PLC single-cycle stop, fixed-length stop, and valid STOP/RST stop during terminal control. (See P07.04.)</p> <p>These function codes specify the delay time corresponding to the electrical level changes when the programmable input terminals switch on or switch off.</p> <p>Note: The communication address is 0x200A.</p>
P05.24	S6 switch-on delay	0.000		
P05.25	S6 switch-off delay	0.000		
P05.26	S7 switch-on delay	0.000		
P05.27	S7 switch-off delay	0.000		
P05.28	S8 switch-on delay	0.000		
P05.29	S8 switch-off delay	0.000		

Function code	Name	Default	Setting range	Description
P05.30	HDIA switch-on delay	0.000		
P05.31	HDIA switch-off delay	0.000		
P07.39	Input terminal status at present fault	0x0000	0x0000–0xFFFF	-
P17.12	Digital input terminal state	0x000	0x000–0x1FF	-

6.9.1.2 Digital output

The VFD carries two groups of relay output terminals and one open collector Y output terminal. All the digital output terminal functions can be specified by function codes.

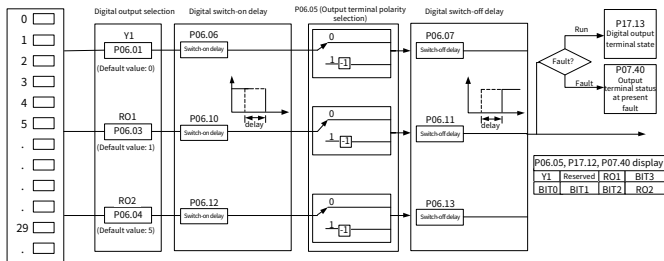

The following table lists the options of function parameters P06.01–P06.04. A same output terminal function can be repeatedly selected.

Setting	Function	Description
0	Invalid	The output terminal does not have any function.
1	Running	The ON signal is output when there is frequency output during running.
2	Running forward	The ON signal is output when there is frequency output during forward running.
3	Running reversely	The ON signal is output when there is frequency output during reverse running.

Setting	Function	Description
4	Jogging	The ON signal is output when there is frequency output during jogging.
5	VFD in fault	The ON signal is output when a VFD fault occurred.
6	Frequency level detection FDT1	Refer to the descriptions for P08.32 and P08.33.
7	Frequency level detection FDT2	Refer to the descriptions for P08.34 and P08.35.
8	Frequency reached	Refer to the description for P08.36.
9	Running in zero speed	The ON signal is output when the VFD output frequency and reference frequency are both zero.
10	Upper limit frequency reached	The ON signal is output when the running frequency reaches the upper limit frequency.
11	Lower limit frequency reached	The ON signal is output when the running frequency reaches the lower limit frequency.
12	Ready to run	The ON signal is output when main circuit and control circuit powers are established, the protection functions do not act, and the VFD is ready to run.
13	Pre-exciting	The ON signal is output when the VFD is in pre-exciting.
14	Overload pre-alarm	The ON signal is output when the pre-alarm time elapsed based on the pre-alarm threshold; for details, see descriptions for P11.08–P11.10.
15	Underload pre-alarm	The ON signal is output after the pre-alarm time elapsed based on the pre-alarm threshold. For details, see the descriptions for P11.11–P11.12.
16	Simple PLC stage completed	When the present state of the simple PLC is completed, it outputs a signal.
17	Simple PLC cycle completed	When a single cycle of the simple PLC is completed, it outputs a signal.
18	Set counting value reached	The ON signal is output when the counting value reaches the value specified by P08.25 if the counting function is enabled.
19	Designated counting value reached	The ON signal is output when the counting value reaches the value specified by P08.26 if the counting function is enabled.
20	External fault is valid	The ON signal is output when the fault is an

Setting	Function	Description
		external fault (E17).
22	Running time reached	The ON is output when the single operation time of VFD reaches the time specified by P08.27.
23	Modbus communication virtual terminal output	A signal is output based on the virtual output terminal of Modbus communication (communication address 0x200B). When the value is 1, the ON signal is output; when the value is 0, the OFF signal is output.
26	DC bus voltage established	When the bus voltage is above the inverter undervoltage, the output is valid.
29	STO action	When an STO fault occurs, the output is valid.
37	Any frequency reached	The ON signal is output when the ramp reference frequency is greater than the value specified by P06.33 and this situation lasts the time specified by P06.34.

Related parameters are listed in the following.

Function code	Name	Default	Setting range	Description								
P06.01	Y1 output selection	0	0-63	For details, see the preceding table.								
P06.03	RO1 output selection	1										
P06.04	RO2 output selection	5										
P06.05	Output terminal polarity selection	0x00	0x00-0x0F	<p>Specifies the output terminal polarity. When a bit is 0, the output terminal is positive. When a bit is 1, the output terminal is negative.</p> <table border="1"> <thead> <tr> <th>BIT3</th> <th>BIT2</th> <th>BIT1</th> <th>BIT0</th> </tr> </thead> <tbody> <tr> <td>RO2</td> <td>RO1</td> <td>Reserved</td> <td>Y1</td> </tr> </tbody> </table>	BIT3	BIT2	BIT1	BIT0	RO2	RO1	Reserved	Y1
BIT3	BIT2	BIT1	BIT0									
RO2	RO1	Reserved	Y1									
P06.06	Y switch-on delay	0.000s	0.000-50.000s	-								
P06.07	Y switch-off delay	0.000s	0.000-50.000s	Used to specify the delay time corresponding to the								

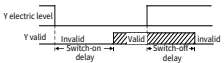
Function code	Name	Default	Setting range	Description
P06.10	RO1 switch-on delay			electrical level changes when the programmable output terminals switch on or switch off.  Setting range: 0.000–50.000s
P06.11	RO1 switch-off delay			
P06.12	RO2 switch-on delay			
P06.13	RO2 switch-off delay			
P06.33	Detection value for frequency being reached	1.00Hz	0–P00.03	The "Any frequency reached" signal is output when the ramp reference frequency is greater than the value specified by P06.33 and this situation lasts the time specified by P06.34.
P06.34	Frequency reaching detection time	0.5s	0–3600.0s	-
P07.40	Output terminal status at present fault	0x0000	0x0000–0xFFFF	-
P17.13	Digital output terminal status	0x00	0x00–0x0F	Displays the present digital output terminal state of the VFD. The bits correspond to RO2, RO1, and Y1 respectively.

6.9.2 Analog input and output terminal functions

6.9.2.1 Analog input

The VFD carries two analog input terminals AI1 and AI2. The input range of AI1 is 0–10V/20mA, and whether AI1 uses voltage input or current input can be specified by P05.52. The input range of AI2 is 0–10V. The input source of AI3 is the keypad potentiometer. Each input can be filtered separately, and the corresponding reference curve can be set by adjusting the reference values that correspond to the

max. value and min. value.

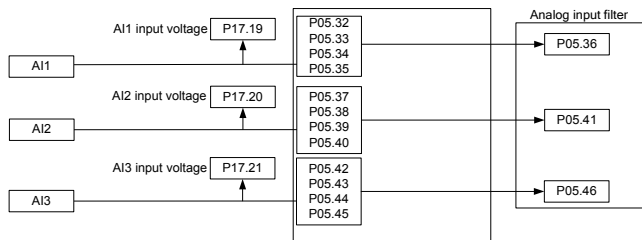

Function code	Name	Default	Setting range	Description
P00.06	Setting channel of A frequency command	0	0-8	1: AI1 2: AI2 3: AI3
P00.07	Setting channel of B frequency command	1		
P03.11	Torque setting method	0	0-7	2: AI1 3: AI2 4: AI3
P03.14	Setting source of forward rotation upper-limit frequency in torque control	0	0-6	1: AI1 2: AI2 3: AI3
P03.15	Setting source of reverse rotation upper-limit frequency in torque control	0	0-6	1: AI1 2: AI2 3: AI3
P03.18	Setting source of electromotive torque upper	0	0-5	1: AI1 2: AI2 3: AI3

Function code	Name	Default	Setting range	Description
	limit			
P03.19	Setting source of braking torque upper limit	0	0–5	1: AI1 2: AI2 3: AI3
P04.27	Voltage setting channel	0	0–7	1: AI1 2: AI2 3: AI3
P05.32	AI1 lower limit	0.00V	0.00–P05.34V	<p>Used to define the relationship between the analog input voltage and its corresponding setting. When the analog input voltage exceeds the range from the upper limit to the lower limit, the upper limit or lower limit is used.</p> <p>When the analog input is current input, 0mA–20mA current corresponds to 0V–10V voltage.</p> <p>In different applications, 100.0% of the analog setting corresponds to different nominal values. See the descriptions of each application section for details.</p> <p>The following figure illustrates the cases of several settings:</p>
P05.33	Corresponding setting of AI1 lower limit	0.0%	-300.0–300.0%	
P05.34	AI1 upper limit	10.00V	P05.32–10.00V	
P05.35	Corresponding setting of AI1 upper limit	100.0%	-300.0–300.0%	
P05.36	AI1 input filter time	0.030s	0.000–10.000s	
P05.37	AI2 lower limit	0.00V	0.00–P05.39V	
P05.38	Corresponding setting of AI2 lower limit	0.0%	-300.0–300.0%	
P05.39	AI2 upper limit	10.00V	P05.37–10.00V	
P05.40	Corresponding setting of AI2 upper limit	100.0%	-300.0–300.0%	
P05.41	AI2 input filter time	0.030s	0.000–10.000s	
P05.42	AI3 lower limit	0.00V	0.00–P05.44V	
P05.43	Corresponding setting of AI3 lower limit	0.0%	-300.0–300.0%	
P05.44	AI3 upper limit	10.00V	P05.42–10.00V	
P05.45	Corresponding setting of AI3 upper limit	100.0%	-300.0–300.0%	

Function code	Name	Default	Setting range	Description
P05.46	AI3 input filter time	0.030s	0.000–10.000s	<p>Input filter time: to adjust the sensitivity of analog input. Increasing the value properly can enhance analog input anti-interference but may reduce the sensitivity of analog input.</p> <p>Note: AI1 supports the 0–10V/0–20mA input. When AI1 selects the 0–20mA input, the corresponding voltage of 20mA is 10V. AI2 supports the 0–10V input.</p>
P05.52	AI1 input signal type	0	0–1	0: Voltage 1: Current
P05.53	AI3 input signal source selection	0	0–1	0: Local potentiometer 1: External potentiometer
P09.00	PID reference source selection	0	0–6	1: AI1 2: AI2 3: AI3
P09.02	PID feedback source selection	0	0–4	0: AI1 1: AI2 2: AI3

6.9.2.2 Analog output

The VFD carries one analog output terminal (supporting the output of 0–10V/0–20mA). Analog output signal can be filtered separately, and the proportional relationship can be adjusted by setting the max. value, min. value, and the

percentage of their corresponding output. Analog output signal can output motor speed, output frequency, output current, motor torque and motor power at a certain proportion.

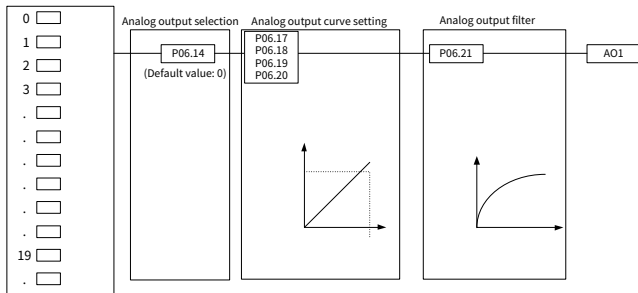

AO output relationship description:

(The min. value and max. value of the output correspond to 0.% and 100.00% of the analog default output. The actual output voltage corresponds to the actual percentage, which can be set through function codes.) Output functions are as follows.

Setting	Function	Description
0	Running frequency	0–Max. output frequency
1	Set frequency	0–Max. output frequency
2	Ramp reference frequency	0–Max. output frequency
3	Rotational speed	0–Synchronous speed corresponding to max. output frequency
4	Output current (relative to the VFD)	0–Twice the VFD rated current
5	Output current (relative to motor)	0–Twice the motor rated current
6	Output voltage	0–1.5 times the VFD rated voltage
7	Output power	0–Twice the motor rated power
8	Set torque value (bipolar)	0–Twice the motor rated current. A negative value corresponds to 0.0% by default.
9	Output torque (absolute value)	0–Twice the motor rated torque or -(Twice the motor rated torque)–0
10	AI1 input	0–10V/0–20mA
11	AI2 input	0V–10V. A negative value corresponds to 0.0%

Setting	Function	Description
		by default.
12	AI3 input	0–10V
13	High-speed pulse HDIA input	0.00–50.00Hz
14	Value 1 set through Modbus communication	0–1000
15	Value 2 set through Modbus communication	0–1000
22	Torque current (bipolar)	0–Three times the motor rated current. A negative value corresponds to 0.0% by default.
23	Exciting current	0–Three times the motor rated current. A negative value corresponds to 0.0% by default.
24	Set frequency (bipolar)	0–Max. output frequency. A negative value corresponds to 0.0% by default.
25	Ramp reference frequency (bipolar)	0–Max. output frequency. A negative value corresponds to 0.0% by default.
26	Rotational speed (bipolar)	0–Synchronous rotation speed corresponding to max. output frequency. A negative value corresponds to 0.0% by default.
30	Rotational speed	0–Twice the motor rated synchronous rotation speed
31	Output torque (bipolar)	0–Twice the motor rated torque. A negative value corresponds to 0.0% by default.

Related parameters are listed in the following.

Function code	Name	Default	Setting range	Description
P06.14	AO1 output selection	0	0–63	0–31. For details, see the preceding table. 32–63: Reserved
P06.17	AO1 output lower limit	0.0%	-300.0%–P06.19	Used to define the relationship between the output value and analog output. When the output value exceeds the allowed
P06.18	AO1 output corresponding to lower limit	0.00V	0.00V–10.00V	

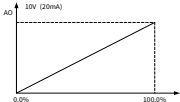
Function code	Name	Default	Setting range	Description
P06.19	AO1 output upper limit	100.0%	P06.17–300.0%	range, the output uses the lower limit or upper limit. When the analog output is current output, 1mA equals 0.5V. In different cases, the corresponding analog output of 100% of the output value is different. 
P06.20	AO1 output corresponding to upper limit	10.00V	0.00V–10.00V	
P06.21	AO1 output filter time	0.000s	0.000s–10.000s	

6.10 RS485 communication

The communication addresses on the communication network are unique, which is the basis of the point-to-point communication between the host controller and VFD. When the master writes the slave communication address to 0 indicating a broadcast address in a frame, all the slaves on the Modbus bus receive the frame but do not respond to it. The local communication address is specified by P14.00. The communication response delay is specified by P14.03, and the RS485 communication timeout time is specified by P14.04.

There are four transmission error processing methods, which can be selected through P14.05. Option 2 (Stop in enabled stop mode without reporting an alarm) is applicable only to the communication mode.

Function code	Name	Default	Setting range	Description
P14.00	Local communication address	1	1–247	The communication address of a slave cannot be set to 0.
P14.01	Communication baud rate setting	4	0–7	Specifies the rate of data transmission between the host controller and the VFD. 0: 1200bps 1: 2400bps 2: 4800bps

Function code	Name	Default	Setting range	Description
				3: 9600bps 4: 19200bps 5: 38400bps 6: 57600bps 7: 115200bps Note: The baud rate set on the VFD must be consistent with that on the host controller. Otherwise, the communication fails. A greater baud rate indicates faster communication.
P14.02	Data bit check setting	1	0-5	The data format set on the VFD must be consistent with that on the host controller. Otherwise, the communication fails. 0: No check (N, 8, 1) for RTU 1: Even check (E, 8, 1) for RTU 2: Odd check (O, 8, 1) for RTU 3: No check (N, 8, 2) for RTU 4: Even check (E, 8, 2) for RTU 5: Odd check (O, 8, 2) for RTU
P14.03	Communication response delay	5ms	0-200ms	The function code indicates the communication response delay, that is, the interval from when the VFD completes receiving data to when it sends response data to the host controller. If the response delay is shorter than the rectifier processing time, the rectifier sends response data to the host controller after processing data. If the delay is longer than the rectifier processing

Function code	Name	Default	Setting range	Description
				time, the rectifier does not send response data to the host controller until the delay is reached although data has been processed.
P14.04	RS485 communication timeout period	0.0s	0.0 (invalid)–60.0s	When P14.04 is set to 0.0, the communication timeout time is invalid. When P14.04 is set to a non-zero value, the system reports the "Modbus communication fault" (E18) if the communication interval exceeds the value. In general, the function code is set to 0.0. When continuous communication is required, you can set the function code to monitor communication status.
P14.05	Transmission fault processing	0	0–3	0: Report an alarm and coast to stop 1: Keep running without reporting an alarm 2: Stop in enabled stop mode without reporting an alarm (applicable only to communication mode) 3: Stop in enabled stop mode without reporting an alarm (applicable to any mode)
P14.06	Modbus communication processing action selection	0x000	0x000–0x111	Ones place: 0: Respond to write operations 1: Not respond to write operations Tens place: 0: Communication password

Function code	Name	Default	Setting range	Description
				protection is invalid. 1: Communication password protection is valid. Hundreds place: User-defined address (valid only for RS485 communication) 0: User-defined addresses specified by P14.07 and P14.08 are invalid. 1: User-defined addresses specified by P14.07 and P14.08 are valid.
P14.07	User-defined running command address	0x2000	0x0000–0xFFFF	-
P14.08	User-defined frequency setting address	0x2001	0x0000–0xFFFF	-

6.11 Monitoring parameters

Monitoring parameters mainly fall in groups P07 and P17, which are used to view and analyze the VFD control and use status. The monitored content is listed in the following.

Group	Type	Monitored content
Group P07	HMI	VFD information, module temperature, run time, power usage, fault history, and software version.
Group P17	Basic status viewing	Frequency information Current information Voltage information Torque and power information Input terminal information Output terminal information PID regulator information Control word and status word information

Group P07—Human-machine interface (HMI)

Function code	Name	Default	Setting range	Description
P07.11	Control board software version	Version depended	1.00–655.35	-
P07.12	Inverter temperature	0.0°C	-20.0–120.0°C	-
P07.13	Drive board software version	Version depended	1.00–655.35	-
P07.14	Local accumulative running time	0h	0–65535h	-
P07.15	VFD electricity consumption high bit	0kWh	0–65535kWh (*1000)	Displays the electricity consumption of the VFD. VFD electricity consumption = P07.15*1000 + P07.16
P07.16	VFD electricity consumption low bit	0kWh	0.0–999.9kWh	
P07.18	VFD rated power	Model depended	0.4–3000.0kW	-
P07.19	VFD rated voltage	Model depended	50–520V	-
P07.20	VFD rated current	Model depended	0.01–600.00A	-
P07.27	Present-fault type	0	0–46	0: No fault 1–3: Reserved 4: Overcurrent during ACC (E4) 5: Overcurrent during DEC (E5) 6: Overcurrent during constant speed running (E6) 7: Overvoltage during ACC (E7) 8: Overvoltage during DEC (E8)
P07.28	Last-fault type	0		
P07.29	2nd-last fault type	0		
P07.30	3rd-last fault type	0		

Function code	Name	Default	Setting range	Description
P07.31	4th-last fault type	0		9: Overvoltage during constant speed running (E9) 10: Bus undervoltage fault (E10) 11: Motor overload (E11) 12: VFD overload (E12) 13: Phase loss on input side (E13) 14: Phase loss on output side (E14) 15: Reserved
P07.32	5th-last fault type	0		16: Inverter module overheat (E16) 17: External fault (E17) 18: Modbus communication fault (E18) 19: Current detection fault (E19) 20: Motor autotuning fault (E20) For full fault information, see the function parameter list.
P07.33	Running frequency at present fault	0.00Hz	0.00Hz-P00.03	-
P07.34	Ramp reference frequency at present fault	0.00Hz	0.00Hz-P00.03	-
P07.35	Output voltage at present fault	0V	0-1200V	-
P07.36	Output current at present fault	0.00A	0.00-630.00A	-
P07.37	Bus voltage at present fault	0.0V	0.0-2000.0V	-

Function code	Name	Default	Setting range	Description
P07.38	Max. temperature at present fault	0.0°C	-20.0-120.0°C	-
P07.39	Input terminal status at present fault	0x0000	0x0000-0xFFFF	-
P07.40	Output terminal status at present fault	0x0000	0x0000-0xFFFF	-
P07.41	Running frequency at last fault	0.00Hz	0.00Hz-P00.03	-
P07.42	Ramp reference frequency at last fault	0.00Hz	0.00Hz-P00.03	-
P07.43	Output voltage at last fault	0V	0-1200V	-
P07.44	Output current at last fault	0.00A	0.00-630.00A	-
P07.45	Bus voltage at last fault	0.0V	0.0-2000.0V	-
P07.46	Temperature at last fault	0.0°C	-20.0-120.0°C	-
P07.47	Input terminal status at last fault	0	0x0000-0xFFFF	-
P07.48	Output terminal status at last fault	0	0x0000-0xFFFF	-
P07.49	Running frequency at	0.00Hz	0.00Hz-P00.03	-

Function code	Name	Default	Setting range	Description
	2nd-last fault			
P07.50	Ramp reference frequency at 2nd-last fault	0.00Hz	0.00Hz–P00.03	-
P07.51	Output voltage at 2nd-last fault	0V	0–1200V	-
P07.52	Output current at 2nd-last fault	0.00A	0.00–630.00A	-
P07.53	Bus voltage at 2nd-last fault	0.0V	0.0–2000.0V	-
P07.54	Temperature at 2nd-last fault	0.0°C	-20.0–120.0°C	-
P07.55	Input terminal status at 2nd-last fault	0	0x0000–0xFFFF	-
P07.56	Output terminal status at 2nd-last fault	0	0x0000–0xFFFF	-

Group P17—Status viewing

Basic status viewing

Function code	Name	Default	Setting range	Description
P17.40	Motor control mode	0x000	0x000–0x122	0x000–0x122 Ones place: Control mode 0: Open-loop vector control 1: Reserved 2: V/F control Tens place: Open-loop vector control mode 0: SVC0

Function code	Name	Default	Setting range	Description
				1: SVC1 2: Reserved Hundreds place: Motor type 0: Asynchronous motor (AM) 1: Synchronous motor (SM)
P17.12	Digital input terminal status	0x000	0x000–0x1FF	Displays the present digital input terminal state of the VFD. The bits correspond to HDIA, S8, S7, S6, S5, S4, S3, S2, and S1 respectively.
P17.13	Digital output terminal status	0x000	0x00–0x0F	Displays the present digital output terminal state of the VFD. The bits correspond to RO2, RO1, Reserved, and Y1 respectively.

Frequency related information

Function code	Name	Default	Setting range	Description
P17.00	Set frequency	50.00Hz	0.00Hz–P00.03	Displays the present set frequency of the VFD.
P17.01	Output frequency	0.00Hz	0.00Hz–P00.03	Displays the present output frequency of the VFD.
P17.02	Ramp reference frequency	0.00Hz	0.00Hz–P00.03	Displays the present ramp reference frequency of the VFD.
P17.05	Motor rotation speed	0RPM	0–65535RPM	Displays the current motor speed.
P17.10	Estimated motor frequency	0.00Hz	0.00Hz–P00.03	Displays the estimated motor rotor frequency under the open-loop vector condition.
P17.14	Digital adjustment	0.00Hz	0.00Hz–P00.03	Displays the adjustment on the VFD through the

Function code	Name	Default	Setting range	Description
	value			UP/DOWN terminal.
P17.16	Linear speed	0	0–65535	-
P17.22	HDIA input frequency	0.000kHz	0.000–50.000 kHz	Displays HDIA input frequency.
P17.43	Forward rotation upper-limit frequency in torque control	50.00Hz	0.00Hz–P00.03	-
P17.44	Reverse rotation upper-limit frequency in torque control	50.00Hz	0.00Hz–P00.03	-
P17.49	Frequency set by A source	0.00Hz	0.00–P00.03	-
P17.50	Frequency set by B source	0.00Hz	0.00–P00.03	-

Voltage related information

Function code	Name	Default	Setting range	Description
P17.03	Output voltage	0V	0–1200V	Displays the present output voltage of the VFD.
P17.11	DC bus voltage	0.0V	0.0–2000.0V	Displays the present DC bus voltage of the VFD.
P17.19	AI1 input voltage	0.00V	0.00–10.00V	Displays the AI1 input signal.
P17.20	AI2 input voltage	0.00V	0.00V–10.00V	Displays the AI2 input signal.
P17.21	AI3 input voltage	0.00V	0.00V–10.00V	Displays the AI3 input signal.

Current related information

Function code	Name	Default	Setting range	Description
P17.04	Output current	0.00A	0.00–500.00A	Displays the valid value of current output current of the VFD.
P17.06	Torque current	0.00A	-300.00–300.00A	Displays the present torque current of the VFD.
P17.07	Exciting current	0.00A	-300.00–300.00A	Displays the present exciting current of the VFD.
P17.33	Exciting current reference	0.00A	-300.00–300.00A	Displays the exciting current reference value under the vector control mode.
P17.34	Torque current reference	0.00A	-300.00–300.00A	Displays the torque current reference value under the vector control mode.

Torque and power related information

Function code	Name	Default	Setting range	Description
P17.08	Motor power	0.0%	-300.0–300.0% (of the motor rated power)	Displays the present motor power; 100% is relative to the rated motor power. A positive value indicates the motoring state while a negative value indicates the generating state.
P17.09	Motor output torque	0.0%	-250.0–250.0%	Displays the present output torque of the VFD; 100% is relative to the rated motor torque. During forward running, a positive value indicates the motoring state while a negative value indicates the generating state. During reverse running, the positive value indicates the generating state while the negative

Function code	Name	Default	Setting range	Description
				value indicates the motoring state.
P17.15	Torque reference value	0.0%	-300.0%–300.0% (of the motor rated current)	Relative to the percentage of the rated torque of the present motor, displaying the torque reference.
P17.25	Motor power factor	1.00	-1.00–1.00	Displays the power factor of the current motor.
P17.36	Output torque	0.0Nm	-3000.0–3000.0Nm	Displays the output torque value. During forward running, a positive value indicates the motoring state while a negative value indicates the generating state. During reverse running, a positive value indicates the generating state while a negative value indicates the motoring state.
P17.41	Electromotive torque upper limit	180.0%	0.0%–300.0% (of the motor rated current)	-
P17.42	Braking torque upper limit	180.0%		-
P17.45	Inertia compensation torque	0.0%	-100.0–100.0%	-
P17.46	Friction compensation torque	0.0%	-100.0–100.0%	-

PID regulator information

Function code	Name	Default	Setting range	Description
P17.23	PID reference	0.0%	-100.0–100.0%	Displays the PID reference

Function code	Name	Default	Setting range	Description
	value			value.
P17.24	PID feedback value	0.0%	-100.0–100.0%	Displays the PID feedback value.
P17.51	PID proportional output	0.00%	-100.0–100.0%	-
P17.52	PID integral output	0.00%	-100.0–100.0%	-
P17.53	PID differential output	0.00%	-100.0–100.0%	-
P17.54	PID present proportional gain	0.00%	0.00–100.00	-
P17.55	PID present integral time	0.00s	0.00–10.00s	-
P17.56	PID present differential time	0.00s	0.00–10.00s	-
P17.38	Process PID output	0.00%	-100.0–100.0%	-

6.12 Protection parameter setting

6.12.1 Overvoltage stalling protection

When the motor is in power generation state (the motor speed is greater than the output frequency), the VFD bus voltage will increase continuously. When the detected bus voltage exceeds the value of P11.04 (Overvoltage stalling protection voltage), the overvoltage stalling protection function adjusts the output frequency based on the VFD ACC/DEC status (to be specific, if the VFD is in the ACC or constant speed state, the VFD will increase the output frequency; if the VFD is in the DEC state, the VFD will increase the DEC time). In this way, the regenerative energy on the bus can be consumed, preventing against VFD overvoltage. If the function does not meet requirements in the actual application, you can adjust parameters related to the current loop and voltage loop.

Figure 6-1 Actions taken for protection against overvoltage stalling

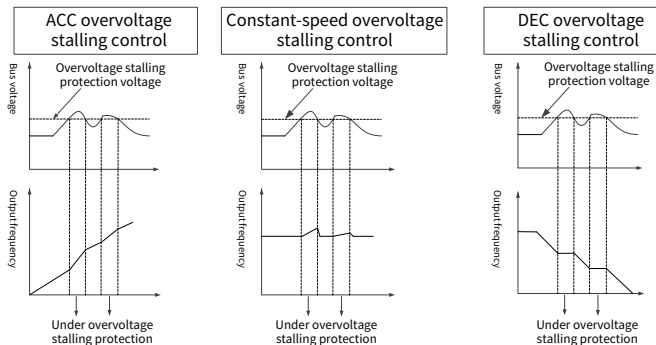

Function code	Name	Default	Setting range	Description
P11.03	Overvoltage stalling protection	1	0-1	0: Disable 1: Enable Note: If the braking resistor or dynamic braking unit is used, disable the overvoltage stalling control function, that is, set P11.03 to 0.
P11.04	Overvoltage stalling protection voltage	136%	120-150% (standard bus voltage)	For 380V models, it is 136% by default.
		120%	120-150% (standard bus voltage)	For 220V models, it is 120% by default.
P11.21	Proportional coefficient of voltage regulator during overvoltage stall	60	0-127	Specifies the proportional coefficient of the bus voltage regulator during overvoltage stalling.

Function code	Name	Default	Setting range	Description
P11.22	Integral coefficient of voltage regulator during overvoltage stall	5	0-1000	Specifies the integral coefficient of the bus voltage regulator during overvoltage stalling.
P11.23	Proportional coefficient of current regulator during overvoltage stall	60	0-1000	Specifies the proportional coefficient of the active current regulator during overvoltage stalling.
P11.24	Integral coefficient of current regulator during overvoltage stall	250	0-2000	Specifies the integral coefficient of the active current regulator during overvoltage stalling.

6.12.2 Current-limit protection

During accelerated running, as the load is too large, the actual acceleration rate of motor is lower than that of output frequency, if no measures are taken, the VFD may trip due to overcurrent during acceleration.

The current-limit protection function detects output current during running, and compares it with the current-limit level specified by P11.06. If it exceeds the current-limit level, the VFD will run at stable frequency during accelerated running, or the VFD will run at decreased frequency during constant-speed running; if it exceeds the current-limit level continuously, the VFD output frequency will drop continuously until reaching the lower limit frequency. When the output current is detected to be lower than the current-limit level again, it will continue accelerated running. In some heavy load scenarios, you can increase the value of P11.06 to improve the VFD output torque.

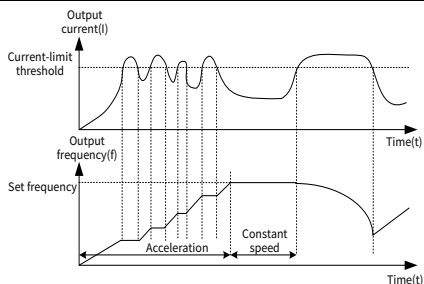

Function code	Name	Default	Setting range	Description
P11.05	Current limit mode	0x01	0x00-0x11	Ones place: Current limit action selection 0: Invalid 1: Always valid Tens place: Hardware current limit overload alarm 0: Valid 1: Invalid
P11.06	Automatic current limit threshold	160.0%	50.0-200.0% (of the VFD rated output current)	-
P11.07	Frequency drop rate during current limit	10.00Hz/s	0.00-50.00Hz/s	-

6.12.3 Frequency decrease at sudden power failure

This function enables the system to keep running at sudden short-period power failure. When power failure occurs, the motor is in the power generation state, the bus voltage is kept at the action determination voltage for frequency decrease at sudden power failure, preventing the VFD from stop due to undervoltage.

If this function does not meet actual requirements, you can set parameters P11.17-P11.20. The speed loop dynamic response characteristics of vector control can be

adjusted by setting the proportional coefficient and integral coefficient of speed regulator. Increasing proportional gain or reducing integral time can accelerate dynamic response of speed loop; however, if the proportional gain is too large or integral time is too small, system oscillation and overshoot may occur; if proportional gain is too small, stable oscillation or speed offset may occur.

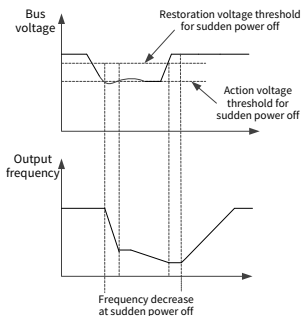

Function code	Name	Default	Setting range	Description
P11.01	Frequency drop at transient power-off	0	0-1	0: Disable 1: Enable
P11.17	Proportional coefficient of voltage regulator during undervoltage stall	20	0-127	Specifies the integral coefficient of the bus voltage regulator during undervoltage stalling.
P11.18	Integral coefficient of voltage regulator during undervoltage stall	5	0-1000	Specifies the integral coefficient of the bus voltage regulator during undervoltage stalling.

Function code	Name	Default	Setting range	Description
P11.19	Proportional coefficient of current regulator during undervoltage stall	20	0-1000	Specifies the proportional coefficient of the active current regulator during undervoltage stalling.
P11.20	Integral coefficient of current regulator during undervoltage stall	20	0-2000	Specifies the integral coefficient of the active current regulator during undervoltage stalling.

6.12.4 Cooling fan control

There are three cooling fan control modes, which can be specified by P08.39.

Function code	Name	Default	Setting range	Description
P08.39	Cooling-fan running mode	0	0-2	0: Normal mode 1: Permanent running after power-on 2: Run mode 2

Note: The fan automatically runs in any mode if the VFD detects that the rectifier bridge or inverter module temperature reaches 50°C.

Normal mode: P08.39 = 0

The cooling fan runs when the VFD runs. The cooling fan stops 30s after the VFD stops.

Permanent running after power-on: P08.39 = 1

The cooling fan runs only if the VFD is powered on.

Run mode 2: P08.39 = 2

The cooling fan runs only when the VFD runs and the ramp frequency is greater than 0. The cooling fan stops 30s after the VFD stops.

6.12.5 Dynamic braking

When the VFD driving a high-inertia load decelerates or needs to decelerate abruptly, the motor runs in the power generation state and transmits the load-carrying energy to the DC circuit of the VFD, causing the bus voltage of the VFD to rise. If the bus voltage exceeds a specific value, the VFD reports an overvoltage fault. To prevent this from happening, you need to configure braking components.

You can set the following parameters for the VFD with a built-in dynamic braking unit:

When P08.37 = 1 and P11.02 = 1, and the bus voltage exceeds the dynamic braking voltage threshold, the braking pipe is opened regardless of whether the VFD is running or stopped. If the bus voltage is less than dynamic braking voltage threshold minus 10V, the braking pipe is closed.

When P08.37 = 1 and P11.02 = 0, and the bus voltage exceeds the dynamic braking voltage threshold, the braking pipe is opened only when the VFD is running. If the bus voltage is less than dynamic braking voltage threshold minus 10V, the braking pipe is closed.

Function code	Name	Default	Setting range	Description
P08.37	Enabling dynamic braking	0	0-1	0: Disable 1: Enable
P08.38	Dynamic braking threshold voltage	For 220V: 380.0V For 380V: 700.0V For 660V: 1120.0V	200.0-1000.0V	Specifies the starting bus voltage of dynamic braking. Adjust this value properly to achieve effective braking for the load. The default value varies depending on the voltage class.
P11.02	Enabling energy-consumption braking for stop	0	0-1	0: Disable 1: Enable

6.12.6 Safe torque off

You can enable the safe torque off (STO) function to prevent unexpected startups when the VFD main power supply is not switched off. The STO function switches off

the VFD output by turning off the drive signals to prevent unexpected startups of the motor. For the VFD with the STO function, set P08.64 to 1. For the VFD without the STO function, set P08.64 to 0. For details, see Appendix E STO function.

Function code	Name	Default	Setting range	Description
P08.52	STO lock selection	0	0–1	0: Lock upon STO alarm Lock upon STO alarm: indicates resetting is required after state restoration if STO occurs. 1: No lock on STO alarm No lock on STO alarm: indicates STO alarm disappears automatically after state restoration if STO occurs.
P08.64	STO function	0	0–1	0: Disable 1: Enable

6.13 Typical applications

6.13.1 Counting

When photoelectric switch pulse signals need to be collected, you can use multifunction digital input terminals to collect signals. That is, set P05.01–P05.04 or P05.09 to 31 (to trigger the counter). To use the HDI counting function, set P05.00 to 1 first.

When P17.18 (Accumulative value) reaches P08.25 (Set counting value), counting restarts. Once the value of P17.18 equals that of P08.25, set the digital output function to 18 to output the ON signal. Similarly, once the value of P17.18 equals that of P08.26, set the digital output function to 19 to output the ON signal.

Function code	Name	Default	Setting range	Description
P05.00	HDI input type	0	0–1	0: HDIA is high-speed pulse input 1: HDIA is digital input
P05.01	S1 function selection	1	0–95	28: Reset the counter, that is, the counting value is cleared 31: Trigger the counter, that is, the counting value is
P05.02	S2 function selection	4		

Function code	Name	Default	Setting range	Description
P05.03	S3 function selection	7		accumulated
P05.04	S4 function selection	0		
P05.09	Function of HDIA	0		
P06.01	Y1 output selection	0	0-63	0: Disable 18: Set counting value reached 19: Designated counting value reached
P06.03	RO1 output selection	1		
P06.04	RO2 output selection	5		
P08.25	Set counting value	0	P08.26-65535	-
P08.26	Designated counting value	0	0-P08.25	-
P17.18	Accumulative counting value	0	0-65535	-

6.13.2 Sleep and wakeup

According to energy saving requirements, the sleep function can be used in water supply scenarios. When the motor needs to run effectively, you can adjust the set frequency to wake up it. The timing diagram is as follows.

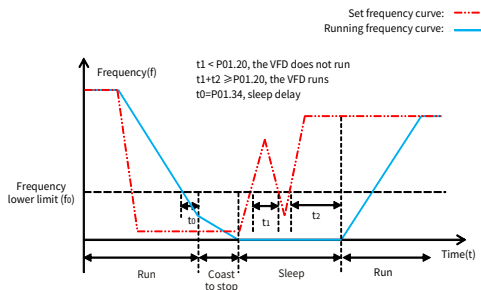

When the set frequency is lower than the frequency lower limit, and the ones place of P01.19 is set to sleep, the VFD stops according to the tens place of P01.19 and sleeps once running at the lower limit for the time specified by P01.34. If the set frequency exceeds the lower limit again and it lasts for the time specified by P01.20, the VFD restores to the running state automatically and increases to the set frequency.

Function code	Name	Default	Setting range	Description
P01.19	Action selected when running frequency less than frequency lower limit (valid when frequency lower limit greater than 0)	0	0x00-0x12	The function code determines the running state of the VFD when the set frequency is lower than the lower-limit one. Ones place: Action selection 0: Run at the frequency lower limit 1: Stop 2: Sleep Tens place: Stop mode 0: Coast to stop 1: Decelerate to stop
P01.20	Wake-up-from-sleep delay	0.0s	0.0-3600.0s	Valid when P01.19 is 2.
P01.34	Sleep delay	0.0s	0.0-3600.0s	-

6.13.3 Switchover between FWD run and REV run

In scenarios with the needs of frequent switchover between FWD run and REV run, you can set P01.14 to increase the torque and stability in the process to decrease the current impact. When P01.14 = 0, the switching frequency point is zero (P01.15). When P01.14 = 1, the switching frequency point is starting frequency (P01.01). Refer to the following figure.

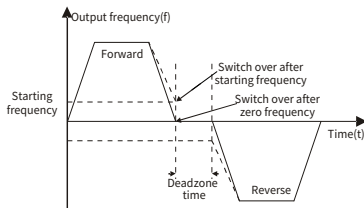

Function code	Name	Default	Setting range	Description
P01.14	FWD/REV running switching mode	1	0-2	0: Switch at zero frequency 1: Switch at the starting frequency 2: Switch after the speed reaches the stop speed with a delay

Switch at the zero or starting frequency: P01.14 = 0 or 1

When P01.14 = 0 or 1, and the switchover between FWD run and REV run is valid, the VFD decelerates to the switching frequency point. If P01.16 = 1, check whether the motor output frequency is less than the switching frequency point. If yes, wait the time specified by P01.13, and then control the motor to run in the reverse direction. If no, wait the time specified by P01.17 and then the time specified by P01.13, and then control the motor to run in the reverse direction.

Switch after the speed reaches the stop speed with a delay: P01.14 = 2

When P01.14 = 2, the DEC process for the switchover between FWD run and REV run is similar to the process of deceleration to stop. In the DEC process for the switchover, you can set related parameters to determine whether to enable short-circuit braking for stop and DC braking based on the work conditions. The difference between the two processes is as follows: When the running frequency reaches the stop speed specified by P01.15 or DC braking ends, the deadzone time

specified by P01.13 needs to be waited, and then the motor can be controlled to run in the reverse direction.

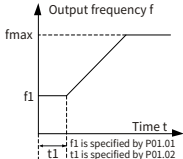
Function code	Name	Default	Setting range	Description
P01.01	Starting frequency of direct start	0.50Hz	0.00–50.00Hz	The function code indicates the initial frequency during VFD start. For details, see the description for P01.02.
P01.02	Hold time of starting frequency	0.0s	0.0–50.0s	Setting a proper starting frequency can increase the torque during VFD start. During the hold time of the starting frequency, the output frequency of the VFD is the starting frequency. And then, the VFD runs from the starting frequency to the set frequency. If the set frequency is lower than the starting frequency, the VFD stops running and keeps in the standby state. The starting frequency is not limited in the lower limit frequency. 
P01.13	FWD/REV running deadzone time	0.0s	0.0–3600.0s	Specifies the transition time specified in P01.14 during switchover between FWD run and REV run.
P01.15	Stop speed	0.50Hz	0.00–100.00Hz	-
P01.16	Stop speed detection	0	0–1	0: Detect by the set speed (unique in space voltage)

Function code	Name	Default	Setting range	Description
	mode			vector control mode) 1: Detect by the feedback speed
P01.17	Stop speed detection time	0.50s	0.00–100.00s	-

6.13.4 Jump frequency

The VFD can avoid mechanical resonance points by setting jump frequencies. The VFD has three jump frequency parameters P08.09, P08.11, and P08.13. If all jump frequencies are set to 0, this function is invalid. When the set frequency is within the jump frequency range (Jump frequency $\pm 1/2 * \text{Jump amplitude}$), if the VFD is in the ACC phase, the VFD runs at the lower bound (Jump frequency $- 1/2 * \text{Jump amplitude}$); if the VFD is in the DEC phase, the VFD runs at the upper bound (Jump frequency $+ 1/2 * \text{Jump amplitude}$).

See the following figure.

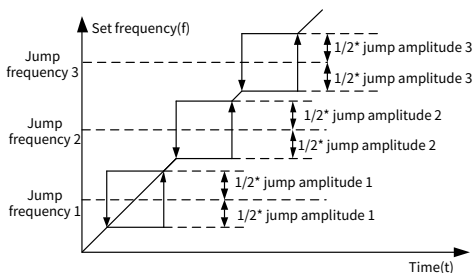

Function code	Name	Default	Setting range	Description
P08.09	Jump frequency 1	0.00Hz	0.00Hz–P00.03	P00.03 specifies the max. output frequency.
P08.10	Jump frequency amplitude 1	0.00Hz	0.00Hz–P00.03	P00.03 specifies the max. output frequency. Refer to P08.09 to set it.
P08.11	Jump	0.00Hz	0.00Hz–	P00.03 specifies the max.

Function code	Name	Default	Setting range	Description
	frequency 2		P00.03	output frequency.
P08.12	Jump frequency amplitude 2	0.00Hz	0.00Hz–P00.03	P00.03 specifies the max. output frequency. Refer to P08.11 to set it.
P08.13	Jump frequency 3	0.00Hz	0.00Hz–P00.03	P00.03 specifies the max. output frequency.
P08.14	Jump frequency amplitude 3	0.00Hz	0.00Hz–P00.03	P00.03 specifies the max. output frequency. Refer to P08.13 to set it.

6.13.5 Wobbling frequency

Wobbling frequency is mainly applied in the scenarios where transverse movement and winding functions are needed such as textile and chemical fiber industries. The wobbling frequency function indicates that the VFD output frequency wobbles up or down with the set frequency as the center, and the output frequency with the wobbling frequency is impacted by the frequency upper and lower limits.

The time axis tracking is as shown in the following figure.

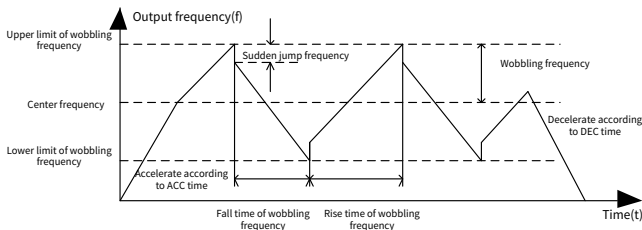

Wobbling frequency = Central frequency (Set frequency) x P08.15 (Amplitude of wobbling frequency)

Sudden jump frequency = Wobbling frequency x P08.16 (Amplitude of sudden jump frequency)

Function code	Name	Default	Setting range	Description
P08.15	Amplitude of wobbling frequency	0.0%	0.0–100.0%	Relative to the set frequency
P08.16	Amplitude of sudden jump frequency	0.0%	0.0–50.0%	Relative to the wobbling frequency
P08.17	Rise time of wobbling frequency	5.0s	0.1–3600.0s	Time taken to run from the lowest point of wobbling frequency to the highest point.
P08.18	Fall time of wobbling frequency	5.0s	0.1–3600.0s	Time taken to run from the highest point of wobbling frequency to the lowest point.
P05.00	HDI input type	0	0–1	0: HDIA is high-speed pulse input 1: HDIA is digital input
P05.01	S1 function selection	1	0–95	0: No function 26: Pause wobbling frequency (stopped at the present frequency) 27: Reset wobbling frequency (returned to the center frequency)
P05.02	S2 function selection	4		
P05.03	S3 function selection	7		
P05.04	S4 function selection	0		
P05.09	HDIA function selection	0		

7 Communication

7.1 Standard communication interface

The VFD provides RS485 communication as a standard configuration. The following table defines the communication terminal function.

Table 7-1 Standard communication terminal

Interface	Network signal	Signal description	Description
IO terminal	485+ 485-	RS485 communication	Terminal for external RS485 communication, supporting the Modbus communication protocol

7.2 Communication data address

The communication data includes VFD-related function parameter data, VFD status parameter data, and VFD control parameter data.

7.2.1 Function parameter address

The address of a function code consists of two bytes, with the MSB on the left and LSB on the right. Both the MSB and LSB also range from 00 to ffH. The MSB is the hexadecimal form of the group number on the left of the dot mark, and LSB is that of the number on the right of the dot mark. Take P05.06 as an example. The group number is 05, that is, the MSB of the parameter address is the hexadecimal form of 05; and the number on the right of the dot mark is 06, that is, the LSB is the hexadecimal form of 06. Therefore, the function code address is 0506H in the hexadecimal form. For P10.01, the parameter address is 0A01H.

Note:

- The parameters in the P29 group are set by the manufacturer and cannot be read or modified. Some parameters cannot be modified when the VFD is running; some cannot be modified regardless of the VFD status. Pay attention to the setting range, unit, and description of a parameter when modifying it.
- Frequently writing to EEPROM will reduce its life time. Some function codes do not need to be stored during communication. The application requirements can be met by modifying the value of the on-chip RAM, that is, modifying the highest-order bit of the corresponding function code address from 0 to 1.
- For example, if P00.07 is not to be stored in the EEPROM, you need only to modify the value in the RAM, that is, set the address to 8007H. The address can

be used only for writing data to the on-chip RAM, and it is invalid when used for reading data.

7.2.2 Non-function parameter address

In addition to modifying the parameters of the VFD, the master can also control the VFD, such as starting and stopping it, and monitoring the operation status of the VFD. The following describes status parameter data addresses and control parameter data addresses.

1. Status parameter

Note: Status parameters are read only.

Parameter	Address	Description
VFD status word 1	2100H	0001H: Forward running
		0002H: Running reversely
		0003H: Stopped
		0004H: Faulty
		0005H: In POFF state
		0006H: In pre-exciting state
VFD status word 2	2101H	Bit0=0: Not ready to run =1: Ready to run Bit2–Bit1: =00: Motor 1 =01: Motor 2 Bit3: =0: AM =1: SM Bit4: =0: No pre-alarm upon overload =1: Overload pre-alarm Bit6–Bit5=00: Keypad-based control =01: Terminal-based control =10: Communication-based control Bit7: Reserved Bit8: =0: Speed control =1: Torque control Bit9: Reserved Bit11–Bit10: =0: Vector 0 =1: Vector 1 =2: Space voltage vector
VFD fault code	2102H	See the description of fault types.
VFD identification code	2103H	0x1200
Running frequency	3000H	0–Fmax (Unit: 0.01Hz)
Set frequency	3001H	0–Fmax (Unit: 0.01Hz)
Bus voltage	3002H	0.0–2000.0V (Unit: 0.1V)

Parameter	Address	Description
Output voltage	3003H	0–1200V (Unit: 1V)
Output current	3004H	0.00–300.0A (Unit: 0.01A)
Rotational speed	3005H	0–65535 (Unit: 1 RPM)
Output power	3006H	-300.0–300.0% (Unit: 0.1%)
Output torque	3007H	-250.0–250.0% (Unit: 0.1%)
Closed-loop setting	3008H	-100.0–100.0% (Unit: 0.1%)
Closed-loop feedback	3009H	-100.0–100.0% (Unit: 0.1%)
Input IO status	300AH	0x000–0x1FF (corresponding to HDIA, S8, S7, S6, S5, S4, S3, S2, and S1 in sequence)
Output IO status	300BH	0x00–0x0F (corresponding to local RO2/RO1/Reserved/Y1)
Analog input 1	300CH	0.00–10.00V (Unit: 0.01V)
Analog input 2	300DH	0.00–10.00V (Unit: 0.01V)
Analog input 3	300EH	0.00–10.00V (Unit: 0.01V)
Read input of HDIA high-speed pulse	3010H	0.00–50.00kHz (Unit: 0.01Hz)
Read the actual step of multi-step speed	3012H	0–15
External length value	3013H	0–65535
External counting value	3014H	0–65535
Torque setting	3015H	-300.0–300.0% (Unit: 0.1%)
VFD identification code	3016H	-
Fault code	5000H	-

2. Control parameter

Note: VFD control parameters can be read and written.

Parameter	Address	Description
Communication-based control command	2000H	0001H: Forward running
		0002H: Reverse running
		0003H: Forward jogging
		0004: Reverse jogging
		0005H: Stop
		0006H: Coast to stop
		0007H: Fault reset
		0008H: Jogging to stop
Communication-based setting address	2001H	Communication-based frequency setting (0–Fmax; unit: 0.01 Hz)
	2002H	PID reference (0–1000, in which 1000 corresponds to 100.0%)
	2003H	PID feedback (0–1000, in which 1000 corresponds to 100.0%)
	2004H	Torque setting (-3000–3000, in which 1000 corresponds to 100.0% of the motor rated current)
	2005H	Upper limit setting of forward running frequency (0–Fmax; unit: 0.01 Hz)
	2006H	Upper limit setting of reverse running frequency (0–Fmax; unit: 0.01 Hz)
	2007H	Upper limit of the electromotive torque (0–3000, in which 1000 corresponds to 100.0% of the motor rated current)
	2008H	Braking torque upper limit (0–3000, in which 1000 corresponds to 100.0% of the motor rated current)
	2009H	Special CW Bit1–Bit0: = 00: Motor 1 = 01: Motor 2 Bit2: = 1 Enable speed/torque control switchover = 0: Disable speed/torque control switchover Bit3: = 1 Clear electricity consumption data = 0: Keep electricity consumption data Bit4: = 1 Enable pre-excitation = 0: Disable

Parameter	Address	Description
		pre-excitation Bit5: =1 Enable DC braking =0: Disable DC braking
	200AH	Virtual input terminal command. Range: 0x000–0x1FF (corresponding to HDIA/S8/S7/S6/S5/S4/S3/S2/S1)
	200BH	Virtual output terminal command. Range: 0x00–0x0F (corresponding to local RO2/RO1/Reserved/Y1)
	200CH	Voltage setting (used when V/F separation is implemented) (0–1000, in which 1000 corresponds to 100.0% of the motor rated voltage)
	200DH	AO setting 1 (-1000–+1000, in which 1000 corresponds to 100.0%)
	200EH	AO setting 2 (-1000–+1000, in which 1000 corresponds to 100.0%)

Note: Some parameters in the preceding table are valid only after they are enabled. For example, for the running or stop operation, you must set "Channel of running commands" (P00.01) to "Communication", and set "Communication channel of running commands" (P00.02) to the Modbus channel.

The following table describes the encoding rules of device codes (corresponding to the identification code 1200 H of the VFD).

8 MSBs	Meaning	8 LSBs	Meaning
0x12	General mechanical type	0x00	Goodrive27 series VFD

7.3 Modbus networking

A Modbus network is a control network with one master and multiple slaves, that is, on one Modbus network, there is only one device serving as the master, and other devices are the slaves. The master can communicate with any single slave or with all slaves. For separate access commands, a slave needs to return a response. For broadcast information, slaves do not need to return responses.

Generally, the PC, industry control device, or programmable logic controller (PLC) functions as the master, while VFDs function as slaves.

7.3.1 Network topology

7.3.1.1 Application to one VFD

Figure 7-1 Application to one VFD

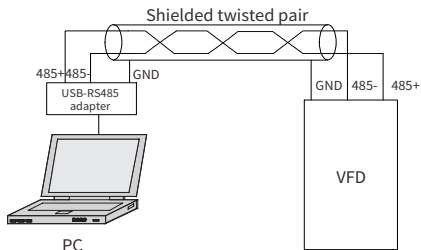

7.3.1.2 Application to multiple VFDs

In practical application to multiple VFDs, the daisy chain connection and star connection are commonly used.

Figure 7-2 Practical daisy chain connection application

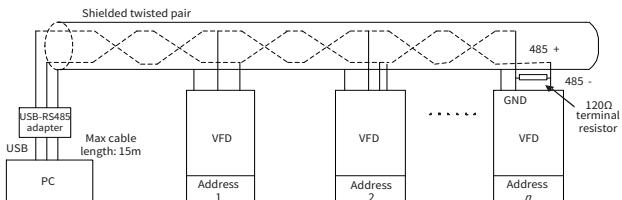
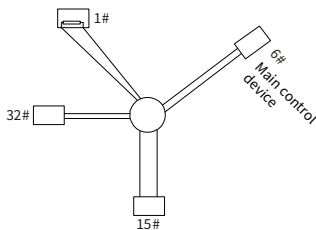

Figure 7-3 Star connection application

**Note:**

- When this connection mode is adopted, the two devices that are farthest away from each other on the line must be connected with a terminal resistor (in the figure, the two devices are #1 device and #15 device).
- Use shielded cables, if possible, in multi-device connection. The baud rates, data bit check settings, and other basic parameters of all the devices on the RS485 line must be set consistently, and addresses cannot be duplicated.

7.3.2 RTU mode

7.3.2.1 RTU communication frame structure

When a controller is set to use the RTU communication mode on a Modbus network, every byte (including eight bits) in the message includes two hexadecimal characters (each includes four bits). Compared with the ASCII mode, the RTU mode achieves transmission of more data at the same baud rate.

In RTU mode, the transmission of a new frame always starts from an idle time (the transmission time of 3.5 bytes). On a network where the transmission rate is calculated based on the baud rate, the transmission time of 3.5 bytes can be easily obtained. After the idle time ends, the data domains are transmitted in the following sequence: slave address, command code, data, and CRC check character. Each byte transmitted in each domain includes 2 hexadecimal characters (0–9, A–F). The network devices always monitor the communication bus. After receiving the first domain (address information), each network device identifies the byte. After the last byte is transmitted, a similar transmission interval (the transmission time of 3.5 bytes) is used to indicate that the transmission of the frame ends. Then, the transmission of a new frame starts.

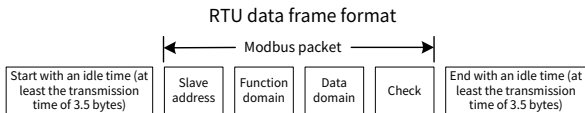

The information of a frame must be transmitted in a continuous data flow. If there is an interval greater than the transmission time of 1.5 bytes before the transmission of the entire frame is complete, the receiving device deletes the incomplete information, and mistakes the subsequent byte for the address domain of a new frame. Similarly, if the transmission interval between two frames is shorter than the transmission time of 3.5 bytes, the receiving device mistakes it for the data of the last frame. The CRC check value is incorrect due to the disorder of the frames, and thus a communication fault occurs.

If the slave detects a communication fault or read/write failure due to another cause, an error frame is replied.

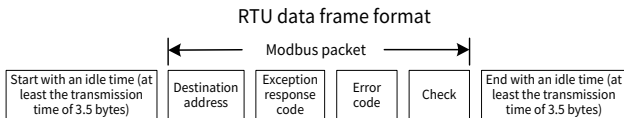

The following table describes the standard structure of an RTU frame.

START (frame header)	T1-T2-T3-T4 (transmission time of 3.5 bytes)
ADDR (slave address domain)	Communication address: 0–247 (decimal system; 0 is the broadcast address)
CMD (function domain)	03H: Read slave parameter; 06H: Write slave parameter
Data domain DATA (N-1) ... DATA (0)	Data of 2*N bytes Main content of the communication as well as the core of data exchanging
CRC CHK LSB	Detection value: CRC (16 bits)
CRC CHK MSB	
END (frame tail)	T1-T2-T3-T4 (transmission time of 3.5 bytes)

7.3.2.2 RTU communication frame error check methods

During the transmission of data, errors may occur due to various factors. Without error check, the data receiving device cannot identify data errors and may make an incorrect response. The incorrect response may cause severe problems. Therefore, the data must be checked.

The error check of a frame includes two parts, namely, bit check on individual bytes (that is, odd/even check using the check bit in the character frame), and whole data check (CRC check).

7.3.2.3 Bit check on individual bytes (odd/even check)

You can select the bit check mode as required, or you can choose not to perform the check, which will affect the check bit setting of each byte.

Definition of even check: Before the data is transmitted, an even check bit is added to indicate whether the number of "1" in the to-be-transmitted data is odd or even. If it is even, the check bit is set to "0"; and if it is odd, the check bit is set to "1".

Definition of odd check: Before the data is transmitted, an odd check bit is added to indicate whether the number of "1" in the to-be-transmitted data is odd or even. If it is odd, the check bit is set to "0"; and if it is even, the check bit is set to "1".

For example, the data bits to be sent are "11001110", including five "1". If the even check is applied, the even check bit is set to "1"; and if the odd check is applied, the odd check bit is set to "0". During the transmission of the data, the odd/even check bit is calculated and placed in the check bit of the frame. The receiving device performs the odd/even check after receiving the data. If it finds that the odd/even parity of the data is inconsistent with the preset information, it determines that a communication error occurs.

7.3.2.4 Cyclic redundancy check (CRC)

A frame in the RTU format includes an error detection domain based on the CRC calculation. The CRC domain checks all the content of the frame. The CRC domain consists of two bytes, including 16 binary bits. It is calculated by the transmitter and added to the frame. The receiver calculates the CRC of the received frame, and compares the result with the value in the received CRC domain. If the two CRC values are not equal to each other, errors occur in the transmission.

During CRC, 0xFFFF is stored first, and then a process is invoked to process a minimum of 6 contiguous bytes in the frame based on the content in the current register. CRC is valid only for the 8-bit data in each character. It is invalid for the start, stop, and parity bits.

During the generation of the CRC values, the "exclusive or" (XOR) operation is performed on the each 8-bit character and the content in the register. The result is placed in the bits from the least significant bit (LSB) to the most significant bit (MSB), and 0 is placed in the MSB. Then, LSB is detected. If LSB is 1, the XOR operation is performed on the current value in the register and the preset value. If LSB is 0, no operation is performed. This process is repeated for 8 times. After the last bit (8th bit) is detected and processed, the XOR operation is performed on the next 8-bit byte

and the current content in the register. The final values in the register are the CRC values obtained after operations are performed on all the bytes in the frame.

The calculation adopts the international standard CRC check rule. You can refer to the related standard CRC algorithm to compile the CRC calculation program as required.

The following is a simple CRC calculation function for your reference (using the C programming language):

```
unsigned int crc_cal_value (unsigned char*data_value,unsigned char
data_length)
{
    int i;
    unsigned int crc_value=0xffff;
    while (data_length--)
    {
        crc_value^=*data_value++;
        for (i=0;i<8;i++)
        {
            if (crc_value&0x0001)
                crc_value= (crc_value>>1) ^0xa001;
            else
                crc_value=crc_value>>1;
        }
    }
    return (crc_value) ;
}
```

In the ladder logic, CKSM uses the table look-up method to calculate the CRC value according to the content in the frame. The program of this method is simple, and the calculation is fast, but the ROM space occupied is large. Use this program with caution in scenarios where there are space occupation requirements on programs.

7.3.3 RTU command code

7.3.3.1 Command code 03H, reading *N* words (continuously up to 16 words)

The command code 03H is used by the master to read data from the VFD. The count

of data to be read depends on the "data count" in the command. A maximum of 16 pieces of data can be read. The addresses of the read parameters must be contiguous. Each piece of data occupies 2 bytes, that is, one word. The command format is presented using the hexadecimal system (a number followed by "H" indicates a hexadecimal value). One hexadecimal value occupies one byte.

The 03H command is used to read information including the parameters and running status of the VFD.

For example, if the master reads two contiguous pieces of data (that is, to read content from the data addresses 0004 H and 0005 H) from the VFD whose address is 01H, the command frame structure is described in the following.

RTU master command (from the master to the VFD) is as follows:

START	T1-T2-T3-T4 (transmission time of 3.5 bytes)
ADDR (address)	01H
CMD (command code)	03H
Start address MSB	00H
Start address LSB	04H
Data count MSB	00H
Data count LSB	02H
CRC LSB	85H
CRC MSB	CAH
END	T1-T2-T3-T4 (transmission time of 3.5 bytes)

"T1-T2-T3-T4 (transmission time of 3.5 bytes)" in "START" and "END" indicates that the RS485 communication needs to be idle for at least the transmission time of 3.5 bytes. An idle time is required to distinguish on message from another to ensure that the two messages are not regarded as one.

"ADDR" is "01H", indicating that the command is sent to the VFD whose address is 01 H. "ADDR" occupies one byte.

"CMD" is "03H", indicating that the command is used to read data from the VFD. "CMD" occupies one byte.

"Start address" indicates the address from which data is read. "Start address" occupies two bytes, with the MSB on the left and LSB on the right.

"Data count" indicates the count of data to be read (unit: word). "Start address" is "0004H" and "Data count" is "0002H", which indicates reading data from the addresses 0004H and 0005H.

CRC check occupies two bytes, with the LSB on the left, and MSB on the right.

RTU slave response (from the VFD to the master) is as follows:

START	T1-T2-T3-T4 (transmission time of 3.5 bytes)
ADDR	01H
CMD	03H
Number of bytes	04H
Address 0004H data MSB	13H
Address 0004H data LSB	88H
Address 0005H data MSB	00H
Address 0005H data LSB	00H
CRC LSB	7EH
CRC MSB	9DH
END	T1-T2-T3-T4 (transmission time of 3.5 bytes)

The definition of the response information is described as follows:

"ADDR" is "01H", indicating that the command is sent from the VFD whose address is 01H. "ADDR" occupies one byte.

"CMD" is "03H", indicating that the message is a VFD response to the 03H command from the master for reading data. "CMD" occupies one byte.

"Number of bytes" indicates the number of bytes between the byte (not included) and the CRC byte (not included). The value "04" indicates that there are four bytes of data between "Number of bytes" and "CRC LSB", that is, "MSB of data in 0004H", "LSB of data in 0004H", "MSB of data in 0005H", and "LSB of data in 0005H".

A record of data contains two bytes, with the MSB on the left and LSB on the right. From the response, the data in 0004H is 1388H, and that in 0005H is 0000H.

CRC check occupies two bytes, with the LSB on the left, and MSB on the right.

7.3.3.2 Command code 06H, writing a word

This command is used by the master to write data to the VFD. One command can be used to write only one piece of data. It is used to modify the parameters and running mode of the VFD.

For example, if the master writes 5000 (1388H) to 0004H of the VFD whose address is 02H, RTU master command (from the master to the VFD) is as follows:

START	T1-T2-T3-T4 (transmission time of 3.5 bytes)
ADDR	02H
CMD	06H
MSB of data writing address	00H
LSB of data writing address	04H
MSB of data content	13H

LSB of data content	88H
CRC LSB	C5H
CRC MSB	6EH
END	T1-T2-T3-T4 (transmission time of 3.5 bytes)

RTU slave response (from the VFD to the master) is as follows:

START	T1-T2-T3-T4 (transmission time of 3.5 bytes)
ADDR	02H
CMD	06H
MSB of data writing address	00H
LSB of data writing address	04H
MSB of data content	13H
LSB of data content	88H
CRC LSB	C5H
CRC MSB	6EH
END	T1-T2-T3-T4 (transmission time of 3.5 bytes)

7.3.3.3 Command code 08H, diagnosis

Sub-function code description:

Sub-function code	Description
0000	Return data based on query requests

For example, for the query about the circuit detection information about the VFD whose address is 01H, the query and response strings are the same.

RTU master command:

START	T1-T2-T3-T4 (transmission time of 3.5 bytes)
ADDR	01H
CMD	08H
Sub-function code MSB	00H
Sub-function code LSB	00H
MSB of data content	12H
LSB of data content	ABH
CRC CHK LSB	ADH
CRC CHK MSB	14H
END	T1-T2-T3-T4 (transmission time of 3.5 bytes)

RTU slave response:

START	T1-T2-T3-T4 (transmission time of 3.5 bytes)
ADDR	01H
CMD	08H

Sub-function code MSB	00H
Sub-function code LSB	00H
MSB of data content	12H
LSB of data content	ABH
CRC CHK LSB	ADH
CRC CHK MSB	14H
END	T1-T2-T3-T4 (transmission time of 3.5 bytes)

7.3.3.4 Command code 10H, continuous writing

The command code 10H is used by the master to write data to the VFD. The quantity of data to be written is determined by "Data quantity", and a maximum of 16 pieces of data can be written.

For example: Writing 5000 (1388H) and 50 (0032H) to 0004H and 0005H of the VFD (as the slave) whose address is 02H

RTU master command (from the master to the VFD) is as follows:

START	T1-T2-T3-T4 (transmission time of 3.5 bytes)
ADDR	02H
CMD	10H
MSB of data writing address	00H
LSB of data writing address	04H
Data count MSB	00H
Data count LSB	02H
Number of bytes	04H
MSB of data 0004H content	13H
LSB of data 0004H content	88H
MSB of data 0005H content	00H
LSB of data 0005H content	32H
CRC LSB	C5H
CRC MSB	6EH
END	T1-T2-T3-T4 (transmission time of 3.5 bytes)

RTU slave response (from the VFD to the master) is as follows:

START	T1-T2-T3-T4 (transmission time of 3.5 bytes)
ADDR	02H
CMD	10H
MSB of data writing address	00H
LSB of data writing address	04H
Data count MSB	00H

Data count LSB	02H
CRC LSB	C5H
CRC MSB	6EH
END	T1-T2-T3-T4 (transmission time of 3.5 bytes)

7.3.4 Fieldbus scale

In practical applications, communication data is represented in the hexadecimal form, but hexadecimal values cannot represent decimals. You can multiply a non-integer by a multiple to obtain an integer, in which the multiple is considered as a fieldbus scale.

The fieldbus scale depends on the number of decimal places in the value specified in "Setting range" or "Default". If there are n (for example, 1) decimal places in the value, the fieldbus scale m (then $m=10$) is the result of 10 to the power of n . For example:

Function code	Name	Parameter description	Setting range	Default
P01.20	Wake-up-from-sleep delay	0.0–3600.0s (valid only when P01.15 = 2)	0.00–3600.0	0.0s

The value specified in "Setting range" or "Default" contains one decimal place, and therefore the fieldbus scale is 10. If the value received by the master is 50, "Delay of auto fault reset" of the VFD is 5.0 ($5.0=50/10$).

To set "Wake-up-from-sleep delay" to 5.0s through Modbus communication, you need first to multiply 5.0 by 10 according to the scale to obtain an integer 50, that is, 32H in the hexadecimal form, and then send the following write command:

01 **06** **01 14** **00 32** **49 E7**
 VFD Write Parameter Parameter CRC
 address command address data

After receiving the command, the VFD converts 50 into 5.0 based on the fieldbus scale, and then sets "Wake-up-from-sleep delay" to 5.0s.

For another example, after sending the "Wake-up-from-sleep delay" parameter read command, the master receives the following response from the VFD:

01 **03** **02** **00 32** **39 91**
 VFD Read 2-byte Parameter CRC
 address command data data

The parameter data is 0032H, that is, 50, and therefore 5.0 is obtained based on the fieldbus scale ($50/10=5.0$). In this case, the master identifies that "Wake-up-from-sleep delay" is 5.0s.

7.3.5 Error message response

Error message responses are sent from the VFD to the master. The following table lists the codes and definitions of the error message responses.

Code	Name	Definition
01H	Invalid command	The command code received by the host controller is not allowed to be executed. The possible causes are as follows: <ul style="list-style-type: none"> • The function code is applicable only on new devices and is not implemented on this device. • The slave is in faulty state when processing this request.
02H	Invalid data address	For the VFD, the data address in the request of the host controller is not allowed. In particular, the combination of the register address and the number of the to-be-sent bytes is invalid.
03H	Invalid data value	The received data domain contains a value that is not allowed. The value indicates the error of the remaining structure in the combined request. Note: It does not mean that the data item submitted for storage in the register includes a value unexpected by the program.
04H	Operation failure	The parameter setting is invalid in the write operation. For example, a function input terminal cannot be set repeatedly.
05H	Incorrect password	The password entered in the password verification address is different from that is specified by P07.00.
06H	Incorrect data frame	The data frame sent from the upper computer is incorrect in the length, or in the RTU format, the value of the CRC check bit is inconsistent with the CRC value calculated by the lower computer.
07H	Parameter read-only	The parameter to be modified in the write operation of the upper computer is a read-only parameter.
08H	Parameter cannot be modified in running	The parameter to be modified in the write operation of the upper computer cannot be modified during the running of the VFD.

Code	Name	Definition
09H	Password protection	If the upper computer does not provide the correct password to unlock the system to perform a read or write operation, the error of "system being locked" is reported.

7.3.6 Communication commissioning

In the following example, a PC is used as the master, an RS232-RS485 converter is used for signal conversion, and the PC serial port used by the converter is COM1 (an RS232 port). The host controller commissioning software is the serial port commissioning assistant Commix1.4, which can be downloaded from the Internet. Download a version that can automatically execute the CRC check function. The following figure shows the interface of Commix.

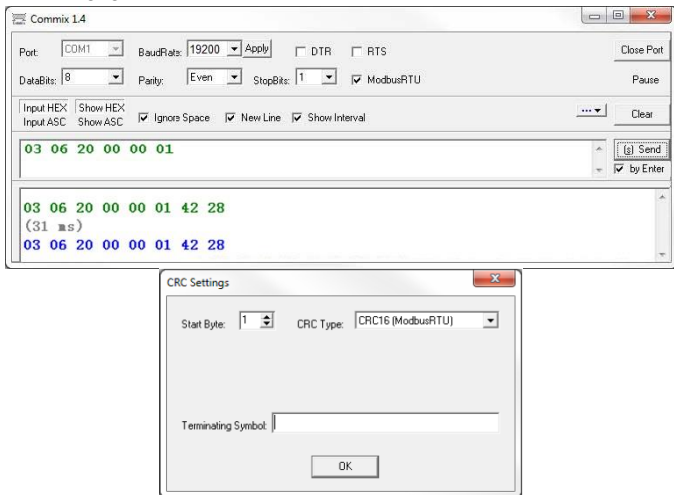

Set **Port** to **COM1**. Set **BaudRate** consistently with P14.01. **DataBits**, **Parity**, and **StopBits** must be set consistently with P14.02. If the RTU mode is selected, choose **Input HEX** and **Show HEX**. To implement automatic CRC, you need to choose **ModbusRTU**, and set **Start Byte** to **1** and **CRC Type** to **CRC16 (MODBUS RTU)** in the **CRC Settings** window. After the automatic CRC is enabled, do not enter CRC in

commands. Otherwise, command errors may occur due to repeated CRC.

The commissioning command for setting the VFD whose address is 03H to run forward is as follows:

<u>03</u>	<u>06</u>	<u>20 00</u>	<u>00 01</u>	<u>42 28</u>
VFD address	Write command	Parameter address	Forward running	CRC

Note:

- The VFD address (P14.00) must be set to 03.
- "Channel of running commands" (P00.01) must be set to "Communication", and "Communication channel of running commands" (P00.02) to the Modbus channel.
- After you click **Send**, if the line configuration and settings are correct, a response transmitted by the VFD is received as follows:

<u>03</u>	<u>06</u>	<u>20 00</u>	<u>00 01</u>	<u>42 28</u>
VFD address	Write command	Parameter address	Forward running	CRC

8 Fault handling

8.1 Fault indication and reset

When the **RUN/TUNE**, **FWD/REV**, and **LOCAL/REMOT** indicators are on at the same time, the VFD is in abnormal state, with the keypad showing the fault code. For details about fault causes and solutions, see 8.2 Faults and solutions. If the fault cause cannot be located, contact our local office for technical support. There are three methods to reset VFD faults:

Method 1 Press the **STOP/RST** key on the keypad for reset.

Method 2 Set P05.01–P05.04 and P05.09 to 7 (Fault reset).

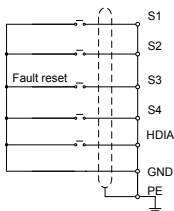

Method 3 Cut off the VFD power supply.

8.2 Faults and solutions

When a fault occurred, handle the fault as follows:

Step 1 Check whether the keypad display is improper. If yes, contact the local INVT office.

Step 2 If no, check the function codes in P07 group to determine the real state when the fault occurred.

Step 3 Check the following table for the exception and solution.

Step 4 Rectify the fault or ask for help.

Step 5 After confirming the fault is removed, perform fault reset, and start running.

8.2.1 Common faults and solutions

Fault code	Fault type	Possible cause	Solution
E4	Overcurrent	ACC/DEC too fast.	Increase ACC/DEC time.

Fault code	Fault type	Possible cause	Solution
E5	during ACC Overcurrent during DEC	The grid voltage is too low.	Increase grid input voltage. Select a VFD with larger power.
E6	Overcurrent during constant speed running	The VFD power is too small; Load transient or exception occurred. 3PH output current imbalance. Strong external interference sources (contactor switchover or improper grounding).	Check for motor stalling, short connection, and load device exceptions. Check for abnormal VFD 3PH output voltage and motor 3PH resistance imbalance. Check for strong interference (whether motor cable is far away from contactor and system is grounded reliably).
E7	Overvoltage during ACC	ACC/DEC time is too short; Exception occurred to input voltage. The motor starts during rotating; Load energy regeneration is too large. Dynamic braking disabled.	Increase ACC/DEC time.
E8	Overvoltage during DEC		Check the input voltage. Wait for the motor to stop steadily, and then start the VFD.
E9	Overvoltage during constant speed running		Install dynamic brake components or regenerative units. Set dynamic braking function parameters.
E10	Bus undervoltage fault	The grid voltage is too low. Abnormal voltage display. Abnormal buffer contactor closing.	Increase grid input voltage. Contact the manufacturer. Contact the manufacturer.
E11	Motor overload	The grid voltage is too low. The motor rated current is set incorrectly. Motor stalling or load sudden change too great.	Increase grid input voltage. Reset the motor rated current in the motor parameter group. Check the load and adjust the torque boost value.
E12	VFD overload	ACC too fast. Motor restarted during rotating.	Increase ACC time. Avoid restart after stop. Increase grid input voltage.

Fault code	Fault type	Possible cause	Solution
		The grid voltage is too low. Load is too large. VFD power is too small.	Select a VFD with larger power.
E13	Input phase loss	Phase loss or violent fluctuation occurred on inputs RST. Input-side screws loosened.	Check whether the input power is normal and input cables are loose. Set P11.00 to screen out the fault.
E14	Output phase loss	Output cables broken or short connected to the ground. UVW phase loss (or the three phases of load are seriously asymmetrical)	Check for loose or broken output cables. Check for sharp load fluctuation and motor 3PH resistance imbalance.
E16	Inverter module overheating	Air duct blocked or fan damaged. Ambient temperature is too high. Long-time overload running.	Ventilate the air duct or replace the fan. Keep good ventilation to lower ambient temperature. Select a VFD with larger power.
E17	External fault	External fault input signal of S terminal acts.	Check whether external device input is normal.
E18	RS485 communication fault	Improper baud rate. Communication line fault. Incorrect communication address. Communication suffers from strong interference.	Set a proper baud rate. Check the communication port wiring. Set the communication address correctly. You are recommended to use shielded cables to improve anti-interference.
E19	Current detection fault	Abnormal motor cable or motor insulation.	Remove motor cables to check. Contact the manufacturer.
E20	Motor autotuning fault	Motor capacity does not match with the VFD capacity. This fault may	Change the VFD model, or adopt V/F mode for control; Check motor wiring, motor

Fault code	Fault type	Possible cause	Solution
		<p>occur if the capacity difference exceeds five power classes.</p> <p>Motor parameter is set improperly.</p> <p>The parameters gained from autotuning deviate sharply from the standard parameters.</p> <p>Autotuning timeout.</p> <p>Pulse current setting too large.</p>	<p>type, and parameter settings.</p> <p>Empty the motor load and carry out autotuning again.</p> <p>Check whether the frequency upper limit is greater than 2/3 of the rated frequency.</p> <p>Decrease the pulse current setting properly.</p>
E21	EEPROM operation fault	<p>Control parameter reading/writing error.</p> <p>EEPROM damaged.</p>	<p>Press STOP/RST to reset.</p> <p>Replace the main control board.</p>
E22	PID feedback offline fault	<p>PID feedback offline.</p> <p>PID feedback source disappears.</p>	<p>Check PID feedback signal wires.</p> <p>Check PID feedback source.</p>
E23	Braking unit fault	<p>Fault occurred to the braking circuit or the braking pipe is damaged.</p> <p>Resistance of the external braking resistor is small.</p>	<p>Check the braking unit, and replace with a new braking pipe.</p> <p>Increase the brake resistance.</p>
E24	Running time reached	<p>The actual running time of the VFD is longer than the internal set running time.</p>	<p>Contact the manufacturer.</p>
E25	Electronic overload fault	<p>The VFD reports overload pre-alarm according to the setting.</p>	<p>Check whether the overload pre-alarm point is set properly.</p>
E27	Parameter upload error	<p>Keypad cable connected improperly or disconnected.</p> <p>Keypad cable too long, causing strong interference.</p> <p>Keypad or mainboard</p>	<p>Check the keypad cable and re-plug to determine whether a fault occurs.</p> <p>Check for and remove the external interference source.</p> <p>Replace the hardware and seek maintenance services.</p>

Fault code	Fault type	Possible cause	Solution
		communication circuit error.	
E28	Parameter download error	Keypad cable connected improperly or disconnected. Keypad cable too long, causing strong interference. Data storage error occurred to the keypad.	Check for and remove the external interference source. Replace the hardware and seek maintenance services. Check whether the version of the control board software of keypad parameter copy is the same as the version of the control board software of the VFD.
E32	To-ground short-circuit fault 1	The output of the VFD is short circuited to the ground.	Check whether the motor is short circuited to the ground and wiring is normal.
E33	To-ground short-circuit fault 2	Current detection circuit is faulty. Actual motor power setup deviates sharply from the VFD power.	Check whether the motor wiring is normal. Replace the main control board. Reset the motor parameters properly.
E34	Speed deviation fault	The load is too heavy or stalled.	Check for overload, increase speed deviation detection time, or prolong ACC/DEC time. Check motor parameter settings and re-perform motor parameter autotuning. Check whether speed loop control parameters are set properly.
E35	Mal-adjustment fault	Load exception occurred. SM parameters are set incorrectly. The parameters gained from autotuning are inaccurate.	Check for overload or stalling. Check motor parameter and counter EMF settings. Re-perform motor parameter autotuning. Increase maladjustment

Fault code	Fault type	Possible cause	Solution
		The VFD is not connected to the motor. Flux weakening application.	detection time. Adjust flux weakening coefficient and current loop parameters.
E36	Electronic underload fault	The VFD reports underload pre-alarm according to the setting.	Check the load and the underload pre-alarm points.
E40	Safe torque off	Safe torque off function is enabled by external forces.	-
E41	Exception occurred to safety circuit of channel 1	The wiring of STO is improper. Fault occurred to external switch of STO.	Check whether terminal wiring of STO is proper and firm enough. Check whether the external switch of STO can work properly.
E42	Exception occurred to safety circuit of channel 2	Hardware fault occurred to safety circuit of channel.	Replace the control board.  Note: Re-power on is required to remove the fault.
E43	Exception occurred to channel 1 and channel 2	Hardware fault occurred to STO circuit.	Replace the control board.
E92	AI1 disconnection	AI1 input too low. AI1 wiring disconnected.	Connect a 5V or 10mA power source to check whether the input is normal. Check whether the wiring is normal; if yes, replace the cable.
E93	AI2 disconnection	AI2 input too low. AI2 wiring disconnected.	
E94	AI3 disconnection	AI3 input too low. AI3 wiring disconnected.	

8.2.2 Other status

Display code	Status type	Possible cause	Solution
PoFF	System power failure	The system is powered off or the bus voltage is too low.	Check the grid conditions.

8.3 Analysis on common faults

8.3.1 Motor fails to work

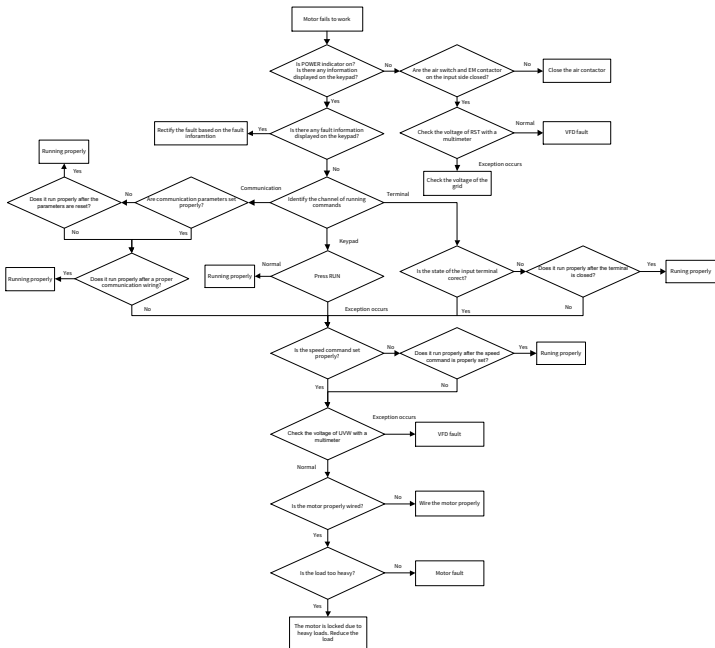

8.3.2 Motor vibrates

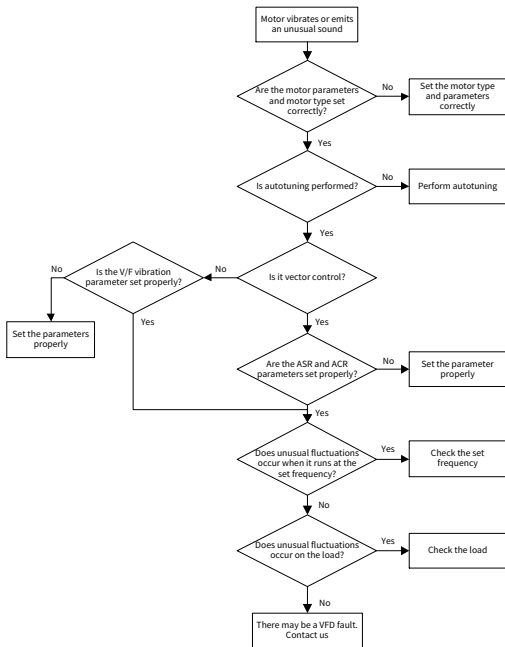

8.3.3 Overvoltage

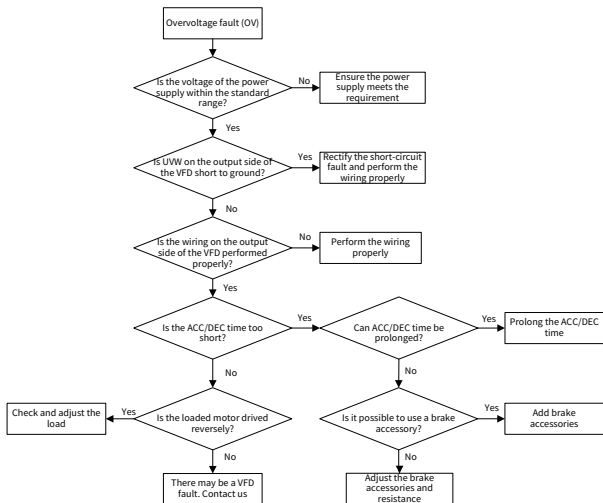

8.3.4 Undervoltage

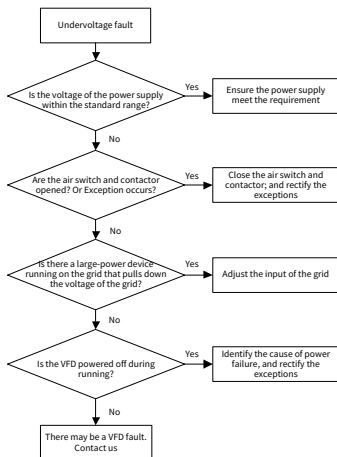

8.3.5 Overcurrent

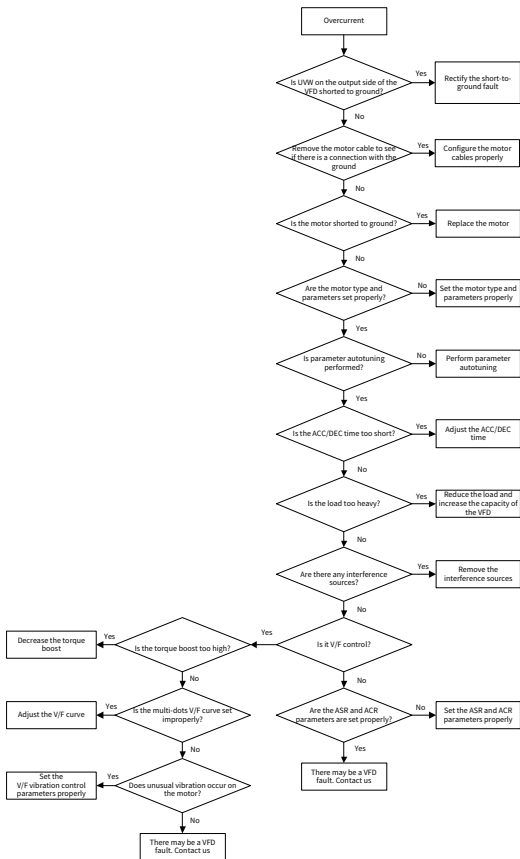

8.3.6 Motor overheating

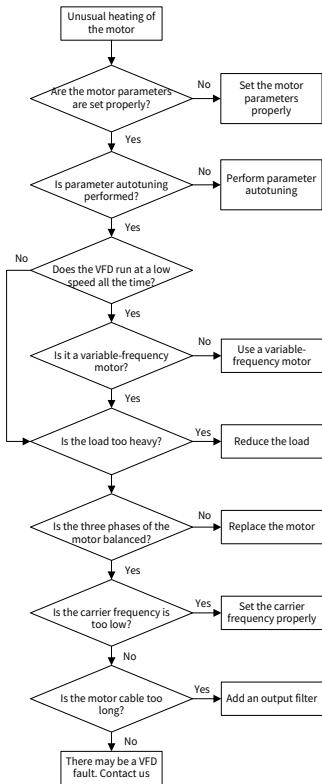

8.3.7 VFD overheating

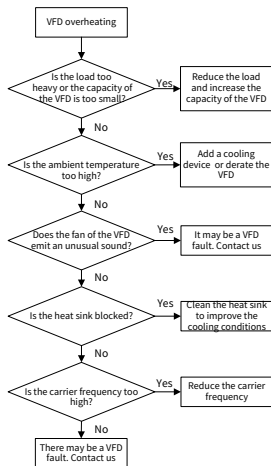

8.3.8 Motor stalls during ACC

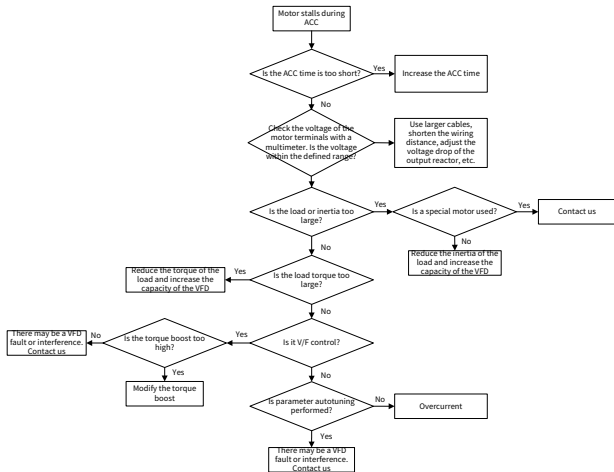

8.4 Countermeasures on common interference

8.4.1 Interference problems of meter switch and sensors

Symptom	Solution
The upper or lower limit is wrongly displayed, for example, 999 or -999.	<ul style="list-style-type: none"> Check and ensure that the sensor feedback cable is 20cm or farther away from the motor cable. Check and ensure that the ground wire of the motor is connected to the PE terminal of the VFD (if the ground wire of the motor has been connected to the ground block, you need to use a multimeter to measure and ensure that the resistance between the ground block and PE terminal is lower than 1.5 Ω). At the same time, you need to fasten the EMC screw at the VFD input side (for the EU models). Try to add a safety capacitor of 0.1μF to the signal end of the feedback signal terminal of the sensor. Try to add a safety capacitor of 0.1μF to the power end of the sensor meter (pay attention to the voltage
The display of values jumps (usually occurring on pressure transmitters).	
The display of values is stable, but there is a large deviation, for example, the temperature is dozens of degrees higher than the common temperature	

Symptom	Solution
(usually occurring on thermocouples).	of the power supply and the voltage endurance of the capacitor).
A signal collected by a sensor is not displayed but functions as a drive system running feedback signal. For example, the VFD is expected to decelerate when the upper pressure limit of the compressor is reached, but in actual running, it starts to decelerate before the upper pressure limit is reached.	<ul style="list-style-type: none"> ● For interference when connecting the VFD analog output (AO1) terminal to a meter: If AO1 uses 0–20mA current signal, add a capacitor of 0.47μF between the AO1 and GND terminals; if AO1 uses 0–10V voltage signal, add a capacitor of 0.1μF between the AO1 and GND terminals. ● The signal cable needs to use the shielded cable, and the shield layer must be grounded reliably to the PE or GND.
All kinds of meters (such as frequency meter and current meter) connected to the VFD AO terminal (AO1) display very inaccurate values.	
Proximity switches are used in the system. After the VFD is started, the indicator of a proximity switch flickers, and the output level flips.	

Note:

- When a decoupling capacitor is required, add it to the terminal of the device connected to the sensor. For example, if a thermocouple is to transmit signals of 0 to 20 mA to a temperature meter, the capacitor needs to be added on the terminal of the temperature meter.; if an electronic ruler is to transmit signals of 0 to 30 V to a PLC signal terminal, the capacitor needs to be added on the terminal of the PLC.
- If a large number of meters or sensors are disturbed, it is recommended that you configure an external C2 filter on the VFD input power end. For details, see D.3.2 Filter.

8.4.2 Interference on RS485 communication

Symptom	Solution
The RS485 communication bus is disconnected or in poor contact.	<ul style="list-style-type: none"> ● Arrange the communication cables and motor cables in different cable trays. ● In multi-VFD application scenarios, adopt the chrysanthemum connection mode to connect the communication cables between VFDs, which can improve the anti-interference capability.
The two ends of line A or B are connected reversely.	<ul style="list-style-type: none"> ● In multi-VFD application scenarios, check and ensure that the driving capacity of the master is sufficient. ● In the connection of multiple VFDs, you need to configure one 120 Ω terminal resistor on each end. ● Check and ensure that the ground wire of the motor is connected to the PE terminal of the VFD (if the ground wire of the motor has been connected to the ground block of the VFD, you need to use a multimeter to measure and ensure that the resistance between the ground block and PE terminal is lower than 1.5 Ω). At the same time, you need to fasten the EMC screw at the VFD input side (for the EU models).
The communication protocol (such as the baud rate, data bits, and check bit) of the VFD is inconsistent with that of the host controller.	<ul style="list-style-type: none"> ● Do not connect the VFD and motor to the same ground terminal as the host controller (such as the PLC, HMI, and touch screen). It is recommended that you connect the VFD and motor to the power ground, and connect the host controller separately to a ground stud. ● Try to short the signal reference ground terminal (GND) of the VFD with that of the upper computer controller to ensure that ground potential of the communication chip on the control board of the VFD is consistent with that of the communication chip of the host controller. ● Try to short GND of the VFD to its ground terminal (PE). ● Try to add a safety capacitor of 0.1μF at the power supply end of the host controller (PLC, HMI, or touch screen). Alternatively, use a magnet ring (Fe-based nanocrystalline magnet rings are recommended).

Symptom	Solution
	Pass the L/N cable or +/- cable of the host controller power supply through the magnet ring in the same direction and wind around the magnet ring for 8 turns.

8.4.3 Failure to stop and indicator shimmering due to motor cable coupling

Symptom	Solution
<p>Failure to stop</p> <p>In a VFD system where an S terminal is used to control the start and stop, the motor cable and control cable are arranged in the same cable tray. After the system is started properly, the S terminal cannot be used to stop the inverter.</p>	<ul style="list-style-type: none"> ● Check and ensure that the exception signal cable is arranged 20 cm or farther away from the motor cable. ● Add a safety capacitor of 0.1μF between the digital input terminal (S) and the GND terminal. ● Connect the digital input terminal (S) that controls the start and stop to other idle digital input terminals in parallel. For example, if S1 is used to control the start and stop and S4 is idle, you can try to short connect S1 to S4.
<p>Indicator shimmering</p> <p>After the VFD is started, the relay indicator, power distribution box indicator, PLC indicator, and indication buzzer shimmer, blink, or emit unusual sounds unexpectedly.</p>	

Note: If the controller (such as PLC) in the system controls more than 5 VFDs at the same time through digital input terminals, this scheme is not applicable.

8.4.4 Leakage current and interference on RCD

■ Working principle

VFDs output high-frequency PWM voltage to drive motors. In this process, the distributed capacitance between the internal IGBT of a VFD and the heat sink and that between the stator and rotor of a motor may inevitably cause the VFD to

generate high-frequency leakage current to the ground. A residual current operated protective device (RCD) is used to detect the power-frequency leakage current when a grounding fault occurs on a circuit. The application of a VFD may cause misoperation of an RCD.

■ Rules for selecting RCDs

1. Inverter systems are special. In these systems, it is required that the rated residual current of common RCDs at all levels is larger than 200 mA, and the VFDs are grounded reliably.
2. For RCDs, the time limit of an action needs to be longer than that of a next action, and the time difference between two actions need to be longer than 20ms, for example, 1s, 0.5s, or 0.2s.
3. For circuits in VFD systems, electromagnetic RCDs are recommended. Electromagnetic RCDs have strong anti-interference capability, and thus can prevent the impact of high-frequency leakage current.

Electronic RCD	Electromagnetic RCD
Low cost, high sensitivity, small in volume, susceptible to voltage fluctuation of the grid and ambient temperature, and weak anti-interference capability	Requiring highly sensitive, accurate, and stable zero-phase sequence current transformer, using permalloy high-permeability materials, complex process, high cost, not susceptible to voltage fluctuation of the power supply and ambient temperature, strong anti-interference capability

Symptom	Solution
RCD misoperation at the transient VFD power-on	<ul style="list-style-type: none"> ● Solution to RCD misoperation (handling the VFD) Try to remove the EMC screw (for the EU models). Try to decrease the carrier frequency to 1.5kHz (P00.14=1.5). Try to modify the modulation method to "3PH modulation and 2PH modulation" (P08.40=00).
RCD misoperation after VFD running	<ul style="list-style-type: none"> ● Solution to RCD misoperation (handling the system power distribution) Check and ensure that the power cable is not soaking in water. Check and ensure that cables are not damaged or spliced. Check and ensure that no secondary grounding is

Symptom	Solution
	<p>performed on the neutral wire.</p> <p>Check and ensure that the main power cable terminal is in good contact with the air switch or contactor (all screws are tightened).</p> <p>Check 1PH powered devices, and ensure that no earth wires are used as neutral wires by these devices.</p> <p>Do not use shielded cables as VFD power cables and motor cables.</p>

8.4.5 Live device housing

■ Live device housing description

After the VFD is started, there is sensible voltage on the housing, and you may feel an electric shock when touching the housing. The chassis, however, is not live (or the voltage is far lower than the human safety voltage) when the VFD is powered on but not running.

Symptom	Solution
Live device housing	<ul style="list-style-type: none"> ● If there is power distribution grounding or ground stud on the site, ground the VFD cabinet housing through the power ground or stud. ● If there is no grounding on the site, you need to connect the motor housing to the VFD grounding terminal PE, and ensure that the VFD EMC screw (for EM models) has been fastened.

9 Inspection and maintenance

9.1 Daily inspection and regular maintenance

The VFD internal components will become aging due to the influence of environmental temperature, humidity, dust, vibration and other factors, which causes the potential failure or shortens the service life. Therefore, to extend the VFD service life and prevent safety hazards, daily inspection and regular maintenance are required.

Check category	Details	Method
Daily inspection: Recommended on each day.		
Ambient environment	Whether the ambient temperature, humidity, vibration, dust, gas, and oil are too great, and whether there is condensation or water droplets inside and outside the machine	Visual inspection, and use instruments for measurement.
	Whether there are foreign matters, such as tools, or dangerous substances placed nearby	Visual inspection
Power supply voltage	Whether the voltage between the main circuit and control circuit is normal	Multimeter or voltage meter
Keypad	Whether display is clear	Visual inspection
	Whether some characters or fields are displayed incompletely	Visual inspection
Fan	Whether it runs normally	Visual inspection
Load	Whether the motor is overloaded or overheating, or it sounds abnormally.	Visual inspection
Regular maintenance: Recommended on a quarterly basis, especially in harsh environments such as with dust, oil, or corrosive gases. Before regular maintenance, cut off the power and wait at least 15 minutes.		
Whole machine	Whether the bolts become loose or come off	Visual inspection
	Whether the machine is deformed, cracked, or damaged, or the color changes due to overheating and aging	Visual inspection
	Whether much dirt or dust is attached	Visual inspection
	Whether there is abnormal sound or vibration, odor, discoloration (transformer, reactor and fan)	Auditory, olfactory, and visual inspection

Check category	Details	Method
Motor	Whether the installation is secure, motor insulation is normal, and the fan runs properly	Instrument or visual inspection
Cable	Whether there is discoloration, deformation, or damage	Visual inspection
	Whether the cable connectors or bolts become loose	Visual inspection
Connection terminal	Whether there is overheating or damage	Visual inspection
Electrolytic capacitor	Whether there is electrolyte leakage, discoloration, cracks, and housing expansion	Visual inspection
	Whether the safety valve is started	Visual inspection
External braking resistor	Whether there is displacement caused due to overheating	Olfactory and visual inspection
	Whether aging, skin breakage, or wire damage occurs to the resistor cable	Visual inspection, or measuring with a multimeter after removing one cable end
Relay	Whether there is vibration sound during running	Auditory inspection
Control PCB and connector	Whether the screws and connectors become loose	Screw them up.
	Whether there is unusual smell or discoloration	Olfactory and visual inspection
	Whether there is corrosion or rust stains	Visual inspection
Ventilation duct	Whether there are foreign matters blocking or attached to the cooling fan, air inlets, or air outlets	Visual inspection

For more details about maintenance, contact the local INVT office, or visit our website www.invt.com, and choose **Support > Services**.

9.2 Cooling fan replacement

The wearing part of VFD is the cooling fan, of which the service life is closely related to the running environment and maintenance condition.

■ Possible damage cause

Bearing wear, blade aging, water, oil, dust and other environmental factors may

cause circuit board damage.

■ Cooling fan replacement procedure

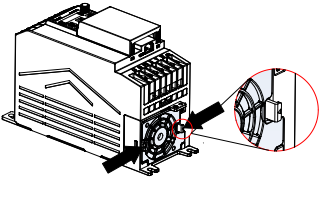
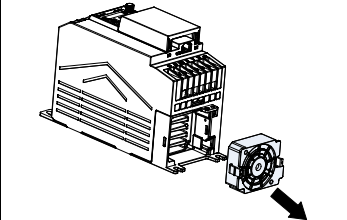
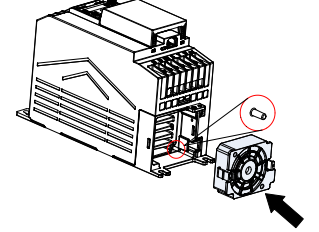
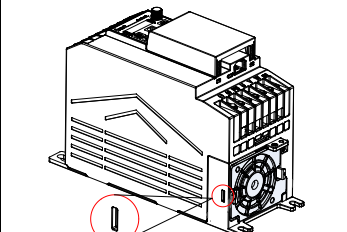
Disassembling a fan	
<p>Step 1 Press the buckles on both sides of the fan with hands.</p>  A line drawing of a VFD with its front cover removed. A cooling fan is visible inside. Red circles highlight the buckles on both sides of the fan. Black arrows point to these buckles, indicating they should be pressed.	<p>Step 2 Pull out the fan outward at the same time.</p>  A line drawing of the VFD with the fan removed. A black arrow points away from the fan, indicating it has been pulled out.
Assembling a fan	
<p>Step 1 Align the two fixing holes on the fan with the positioning column.</p>  A line drawing of the VFD with the fan being inserted. A red circle highlights a hole on the fan, and another red circle highlights a column on the VFD. A black arrow points towards the fan, indicating it should be pushed in.	<p>Step 2 Push in the fan until you hear a clicking sound.</p>  A line drawing of the VFD with the fan fully installed. A red circle highlights the fan's position, and another red circle highlights a hole on the VFD. A black arrow points towards the fan, indicating it has been pushed in.

Note: Before disassembling or installing the VFD, stop the VFD, cut off the power, and wait at least 5 minutes.

9.3 Reforming

If the VFD has been left unused for a long time, you need to follow the instructions to reform the DC bus electrolytic capacitor before using it. The storage time is calculated from the date the VFD is delivered. For detailed operation, contact us.

Storage time	Operation principle
Less than 1 year	No charging operation is required.
1 to 2 years	Before the first run, apply the voltage of one class lower than the VFD voltage class to the VFD for 1 hour.
2 to 3 years	Use a voltage controlled power supply to charge the VFD: <ul style="list-style-type: none"> ● Charge the VFD at 25% of the rated voltage for 30 minutes, ● and then charge it at 50% of the rated voltage for 30 minutes, ● at 75% for another 30 minutes, ● and finally charge it at 100% of the rated voltage for 30 minutes.
More than 3 years	Use a voltage controlled power supply to charge the VFD: <ul style="list-style-type: none"> ● Charge the VFD at 25% of the rated voltage for 2 hours, ● and then charge it at 50% of the rated voltage for 2 hours, ● at 75% for another 2 hours, ● and finally charge it at 100% of the rated voltage for 2 hours.

The method for using a voltage controlled power supply to charge the VFD is described as follows:

The selection of a voltage controlled power supply depends on the power supply of the VFD. For VFDs with an incoming voltage of 1PH/3PH 230 V AC, you can use a 230 V AC/2 A voltage regulator. Both 1PH and 3PH VFDs can be charged with a 1PH voltage controlled power supply (connect L+ to R, and N to S or T). All the DC bus capacitors share one rectifier, and therefore they are all charged.

For VFDs of a high voltage class, ensure that the voltage requirement (for example, 380 V) is met during charging. Capacitor charging requires little current, and therefore you can use a small-capacity power supply (2 A is sufficient).

The method for using a resistor (incandescent lamp) to charge the drive is described as follows:

If you directly connect the drive device to a power supply to charge the DC bus capacitor, it needs to be charged for a minimum of 60 minutes. The charging

operation must be performed at a normal indoor temperature without load, and you must connect a resistor in series mode in the 3PH circuit of the power supply.

For a 380V drive device, use a resistor of 1 k Ω /100W. If the voltage of the power supply is no higher than 380 V, you can also use an incandescent lamp of 100W. If an incandescent lamp is used, it may go off or the light may become very weak.

Figure 9-1 380V drive device charging circuit example

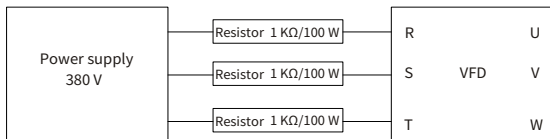

Appendix A Technical data

If the ambient temperature at the VFD installation site exceeds 50°C, the VFD installation site altitude exceeds 1000m, a cover with heat dissipation vents is used, or the carrier frequency is higher than the recommended (see P00.14), the VFD needs to be derated.

A.1 Derating due to temperature

The temperate range is -10°C~+50°C. When the temperature is higher than 50°C, the rated output current of each model is derated as follows:

Table A-1 Derating due to temperature

Model	Frame	Derating coefficient and temperature
GD27-0R4G-S2-B-XX	A	
GD27-0R4G-2-B-EU		
GD27-0R7G-S2-B-XX		
GD27-0R7G-2-B-EU		
GD27-0R7G-4-B-XX		
GD27-1R5G-4-B-XX		
GD27-1R5G-S2-B-XX	B	
GD27-2R2G-S2-B-XX		
GD27-1R5G-2-B-EU		
GD27-2R2G-2-B-EU		
GD27-2R2G-4-B-XX		
GD27-003G-4-B-XX		
GD27-004G-4-B-XX		
GD27-004G-2-B-EU	C	
GD27-5R5G-4-B-XX		
GD27-7R5G-4-B-XX		

Note:

- -XX indicates empty or -EU.
- It is not recommended to use the VFD at an environment with the temperature higher than 60°C. If you do, you shall be held accountable for the consequences caused.

A.2 Derating due to altitude

When the altitude of the site where the VFD is installed is lower than 1000 m, the VFD can run at the rated power. When the altitude exceeds 1000m, derate by 1% for every increase of 100m. When the altitude exceeds 3000m, consult our local dealer or office for details.

A.3 Derating due to carrier frequency

The carrier frequency of the VFD varies with power class. The VFD rated power is defined based on the carrier frequency factory setting.

Model	Derating due to carrier frequency				
	4 KHz	6 KHz	8 KHz	10 KHz	12 KHz
AC 1PH 200V-240V					
GD27-0R4G-S2-B-XX	100%	100%	100%	100%	100%
GD27-0R7G-S2-B-XX	100%	100%	100%	90%	85%
GD27-1R5G-S2-B-XX	100%	100%	100%	100%	90%
GD27-2R2G-S2-B-XX	100%	100%	100%	95%	90%
AC 3PH 200V-240V					
GD27-0R4G-2-B-EU	100%	100%	100%	100%	100%
GD27-0R7G-2-B-EU	100%	100%	100%	90%	85%
GD27-1R5G-2-B-EU	100%	100%	100%	100%	90%
GD27-2R2G-2-B-EU	100%	100%	100%	95%	90%
GD27-004G-2-B-EU	100%	90%	85%	80%	75%
AC 3PH 380V-480V					
GD27-0R7G-4-B-XX	100%	100%	90%	80%	70%
GD27-1R5G-4-B-XX	100%	80%	70%	60%	50%
GD27-2R2G-4-B-XX	100%	90%	80%	75%	70%
GD27-003G-4-B-XX	100%	90%	80%	70%	60%
GD27-004G-4-B-XX	100%	90%	80%	70%	65%
GD27-5R5G-4-B-XX	100%	90%	85%	80%	70%
GD27-7R5G-4-B-XX	100%	90%	85%	80%	70%

Note: -XX indicates empty or -EU.

A.4 Grid specifications

Grid voltage	AC 1PH 200V(-15%) – 240V(+10%) AC 3PH 200V(-15%) – 240V(+10%) AC 3PH 380V(-15%) – 480V(+10%)
Short-circuit capacity	According to the definition in IEC 61439-1, the maximum allowable short-circuit current at the incoming end is 100 kA. Therefore, the VFD is applicable to scenarios where the transmitted current in the circuit is no larger than 100kA when the VFD runs at the maximum rated voltage.
Frequency	50/60Hz±5%, with a maximum change rate of 20%/s

A.5 Motor connection data

Motor type	Asynchronous induction motor or permanent-magnet synchronous motor
Voltage	0–U ₁ (motor rated voltage), 3PH symmetrical, U _{max} (VFD rated voltage) at the field-weakening point
Short-circuit protection	The motor output short-circuit protection meets the requirements of IEC 61800-5-1.
Frequency	0–599Hz
Frequency resolution	0.01Hz
Current	See 2.3 Product ratings.
Power limit	1.5 times the motor rated power
Field-weakening point	10–599Hz
Carrier frequency	4, 8, 12, or 15kHz

A.5.1 Motor cable length for normal operation

Motor cable lengths for normal operation are listed in the following table.

Frame	Max. motor cable length
A	50m
B	75m
C	150mm

Note: When the motor cable is too long, electrical resonance may be caused due to the influence of distributed capacitance. This may cause motor insulation damage or generate large leakage current, causing device overcurrent protection.

You must configure the AC output reactor nearby the VFD when the cable length is equal to or greater than the values in the following table.

A.5.2 Motor cable length for EMC

The EU models meet the EMC requirements of IEC/EN61800-3, and the maximum shielded motor cable lengths used at a 4kHz switching carrier frequency are as follows.

Frame	Max. motor cable length	
	C2	C3
AC 1PH 200V-240V		
A	5m	10m
B	5m	10m
AC 3PH 200V-240V		
A	-	10m
B	-	10m
C	-	10m
AC 3PH 380V-480V		
A	-	10m
B	-	10m
C	-	10m

 **Note:** For details about frames, see 2.5 Product dimensions and weight.

Appendix B Application standards

B.1 List of application standards

The following table describes the application standards that VFDs comply with.

EN/ISO 13849-1	Safety of machinery—Safety related parts of control systems—Part 1: General principles for design
EN/ISO 13849-2	Safety of machinery—Safety related parts of control systems—Part 2: Verification
IEC/EN 60204-1	Safety of machinery—Electrical equipment of machines Part 1: General requirements
IEC/EN 62061	Safety of machinery—Safety-related functional safety of electrical, electronic, and programmable electronic control systems
IEC 61800-3	Adjustable speed electrical power drive systems—Part 3: EMC requirements and specific test methods
IEC/EN 61800-5-1	Adjustable speed electrical power drive systems—Part 5-1: Safety requirements—Electrical, thermal and energy
IEC/EN 61800-5-2	Adjustable speed electrical power drive systems—Part 5-2: Safety requirements—Function

B.2 CE/TUV/UL/CCS certification

The CE mark affixed to the VFD indicates that the VFD is CE-compliant, meeting the regulations of the European low-voltage directive (2014/35/EU) and EMC directive (2014/30/EU).

The TUV mark affixed to the VFD indicates that the VFD is TUV-compliant. TUV certification includes TUV-MARK, TUV-CE, TUV-CB, GS, and VDE certifications, which has high authority and recognition in the field of electronic appliances and components.

The UL mark affixed to the VFD indicates that the VFD has passed UL certification. UL certification is a voluntary certification in the United States (but mandatory in some states), and products that have passed the certification meet the relevant UL standard requirements can enter the US market.

The CCS mark affixed to the VFD indicates that the VFD is CCS-compliant. CCS is the ship inspection certification of China Classification Society. The certified products can be used on ships.

Note: The nameplate of a product shows the actual certification result.

B.3 EMC compliance declaration

EMC is short for electromagnetic compatibility, which refers to the ability of a device or system to function properly in its electromagnetic environment and not constitute an unbearable electromagnetic disturbance to anything in that environment. The VFD is compliant with the EMC product standard (EN 61800-3) and applied to both the first environment and the second environment.

B.4 EMC product standard

The EMC product standard (EN 61800-3) describes the EMC requirements on VFDs.

Application environment categories:

First environment: Civilian environment, including application scenarios where the VFD is directly connected without intermediate transformer to a low-voltage power supply network which supplies residential buildings.

Second environment: All locations outside a residential area.

Category C1: VFD of rated voltage lower than 1000V, applied to the first environment.

Category C2: VFD of rated voltage lower than 1000V, which is neither a non-plug, socket, nor mobile devices and must be installed and commissioned by a professional person when used in the first environment.

Note: The product may generate radio interference in some environments, you need to take measures to reduce the interference.

Category C3: VFD of rated voltage lower than 1000V, applied to the second environment. They cannot be applied to the first environment.

Note: VFDs of category C3 cannot be applied to civilian low-voltage public grids. When applied to such grids, the VFD may generate radio frequency electromagnetic interference.

Category C4: VFD of rated voltage higher than 1000V, or rated current higher or equal to 400A, applied to complex systems in the second environment.

Note: The EMC standard IEC/EN 61800-3 no longer restricts the power distribution of the VFD, but defines the use, installation, and commissioning of the VFD. Specialized personnel or organizations must have the necessary skills (including the EMC-related knowledge) for installing and/or performing commissioning on the electrical drive systems.

Appendix C Dimension drawings

C.1 VFD overall dimensions

Figure C-1 Dimensions and hole positions for VFDs in frames A and B

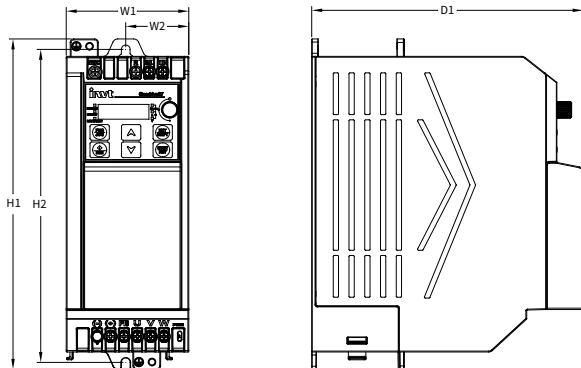

Table C-1 Dimensions and hole positions for VFDs in frames A and B

Model	Frame	Outline dimensions (mm)			Mounting hole distance (mm)		Mounting hole diameter (mm)
		W1	H1	D1	W2	H2	
GD27-0R4G-S2-B-XX	A	60	190	155	36	180	Ø 5
GD27-0R7G-S2-B-XX		60	190	155	36	180	Ø 5
GD27-0R4G-2-B-EU		60	190	155	36	180	Ø 5
GD27-0R7G-2-B-EU		60	190	155	36	180	Ø 5
GD27-0R7G-4-B-XX		60	190	155	36	180	Ø 5
GD27-1R5G-4-B-XX		60	190	155	36	180	Ø 5
GD27-1R5G-S2-B-XX	B	70	190	155	36	180	Ø 5
GD27-2R2G-S2-B-XX		70	190	155	36	180	Ø 5
GD27-1R5G-2-B-EU		70	190	155	36	180	Ø 5
GD27-2R2G-2-B-EU		70	190	155	36	180	Ø 5
GD27-2R2G-4-B-XX		70	190	155	36	180	Ø 5
GD27-003G-4-B-XX		70	190	155	36	180	Ø 5

Model	Frame	Outline dimensions (mm)			Mounting hole distance (mm)		Mounting hole diameter (mm)
		W1	H1	D1	W2	H2	
GD27-004G-4-B-XX		70	190	155	36	180	Ø 5

Note: -XX indicates empty or -EU.

Figure C-2 Dimensions and hole positions for VFDs in frame C

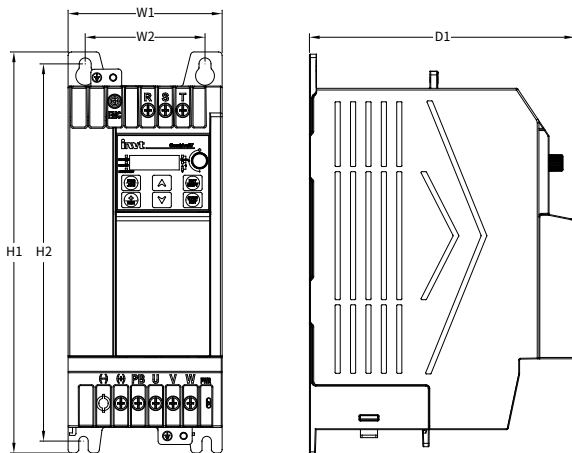

Table C-2 Dimensions and hole positions for VFDs in frame C

Model	Frame	Outline dimensions (mm)			Mounting hole distance (mm)		Mounting hole diameter (mm)
		W1	H1	D1	W2	H2	
GD27-004G-2-B-EU	C	90	235	155	70	220	Ø 6
GD27-5R5G-4-B-XX		90	235	155	70	220	Ø 6
GD27-7R5G-4-B-XX		90	235	155	70	220	Ø 6

Note: -XX indicates empty or -EU.

Appendix D Peripheral accessories

D.1 Cable

Cables mainly include power cables and control cables. For the selection of cable types, see the following table.

Cable type		Symmetrical shielded cable	Four-core cable	Double-shielded twisted-pair cable	Single-shielded twisted-pair cable
Power cable	Input power cable	✓	-	-	-
	Motor cable	✓	-	-	-
Control cable	Analog signal control cable	-	-	✓	-
	Digital signal control cable	-	-	✓	✓

D.1.1 Power cable

Table D-1 Motor model selection

VFD model	R, S, T/U, V, W, PB, (+), (-)		PE		Fastening torque (Nm)
	Recommended cable size (mm ²)	Recommended connection terminal model	Recommended cable size (mm ²)	Recommended connection terminal model	
AC 1PH 200V-240V					
GD27-0R4G-S2-B-XX	1.5	GTVE15008	1.5	TVR/VF1.25-5	1.0
GD27-0R7G-S2-B-XX	1.5	GTVE15008	1.5	TVR/VF1.25-5	1.0
GD27-1R5G-S2-B-XX	2.5	GTVE25012	2.5	TVR/VF2-5	1.0
GD27-2R2G-S2-B-XX	4	GTVE40012	4	TVR/VF3.5-5	1.0
AC 3PH 200V-240V					
GD27-0R4G-2-B-EU	1.5	GTVE15008	1.5	TVR/VF1.25-5	1.0
GD27-0R7G-2-B-EU	1.5	GTVE15008	1.5	TVR/VF1.25-5	1.0
GD27-1R5G-2-B-EU	2.5	GTVE25012	2.5	TVR/VF2-5	1.0
GD27-2R2G-2-B-EU	2.5	GTVE25012	2.5	TVR/VF2-5	1.0

VFD model	R, S, T/U, V, W, PB, (+), (-)		PE		Fastening torque (Nm)
	Recommended cable size (mm ²)	Recommended connection terminal model	Recommended cable size (mm ²)	Recommended connection terminal model	
GD27-004G-2-B-EU	2.5	GTVE25012	2.5	TVR/VF2-6	1.0
AC 3PH 380V-480V					
GD27-0R7G-4-B-XX	1.5	GTVE15008	1.5	TVR/VF1.25-5	1.0
GD27-1R5G-4-B-XX	1.5	GTVE15008	1.5	TVR/VF1.25-5	1.0
GD27-2R2G-4-B-XX	1.5	GTVE15008	1.5	TVR/VF1.25-5	1.0
GD27-003G-4-B-XX	2.5	GTVE25012	2.5	TVR/VF2-5	1.0
GD27-004G-4-B-XX	2.5	GTVE25012	2.5	TVR/VF2-5	1.0
GD27-5R5G-4-B-XX	2.5	GTVE25012	2.5	TVR/VF2-6	1.2
GD27-7R5G-4-B-XX	4	GTVE40012	4	TVR/VF3.5-6	1.2

Note:

- -XX indicates empty or -EU.
- The cables recommended for the main circuit can be used in scenarios where the ambient temperature is lower than 40°C, the wiring distance is shorter than 100m, and the current is the rated current.

■ **Crimp terminal selection**

Due to reasons such as longer cable length or laying, it is necessary to increase the cross-sectional area of the cable and replace the corresponding matching terminal blocks (wire lugs).

GTVE tubular pre-insulated terminal reference brand: Suzhou Yuanli

TVR/VF circular pre-insulated terminal reference brand: Suzhou Yuanli

The terminal models of different brands are named differently, and the actually used models shall prevail.

- ◆ GTVE tubular pre-insulated terminals

Figure D-1 GTVE tubular pre-insulated terminal appearance and size



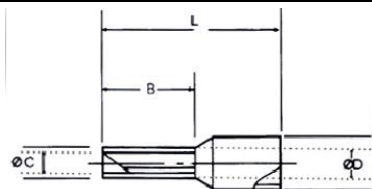

Table D-2 GTVE tubular pre-insulated terminal size

Model	Conductor cross sectional area (mm ²)	Dimensions (mm)				Color	Max. current (A)	Crimping plier																																																																																																				
		L	B	Ø C	Ø D																																																																																																							
02506	0.25	10	6	0.7	1.9	Light blue	3	YAC-5																																																																																																				
02508		12	8						03406	0.34	10	6	0.8	1.9	Pink	5	03408	12	8	05006	0.50	12	6	1.0	2.6	Orange	8	05008	14	8	05010	16	10	07506	0.75	12	6	1.2	2.8	White	10	07508	14	8	07510	16	10	07512	18	12	10006	1.00	12	6	1.4	3.0	Yellow	12	10008	14	8	10010	16	10	10012	18	12	15006	1.50	12	6	1.7	3.5	Red	19	15008	14	8	15010	16	10	15012	18	12	15018	24	18	25008	2.50	14	8	2.2	4.2	Blue	27	25010	16	10	25012	18	12	25018	24	18				
03406	0.34	10	6	0.8	1.9	Pink	5																																																																																																					
03408		12	8						05006	0.50	12	6	1.0	2.6	Orange	8	05008	14	8	05010		16	10					07506	0.75	12	6	1.2	2.8	White		10	07508					14	8	07510	16	10	07512	18	12	10006	1.00		12	6					1.4	3.0	Yellow	12	10008	14	8	10010	16	10		10012	18					12	15006	1.50	12	6	1.7	3.5	Red	19	15008	14	8	15010		16	10					15012	18	12	15018	24	18	25008	2.50	14	8	2.2	4.2	Blue
05006	0.50	12	6	1.0	2.6	Orange	8																																																																																																					
05008		14	8																																																																																																									
05010		16	10																																																																																																									
07506	0.75	12	6	1.2	2.8	White	10																																																																																																					
07508		14	8																																																																																																									
07510		16	10																																																																																																									
07512		18	12																																																																																																									
10006	1.00	12	6	1.4	3.0	Yellow	12																																																																																																					
10008		14	8																																																																																																									
10010		16	10																																																																																																									
10012		18	12																																																																																																									
15006	1.50	12	6	1.7	3.5	Red	19																																																																																																					
15008		14	8																																																																																																									
15010		16	10																																																																																																									
15012		18	12																																																																																																									
15018		24	18																																																																																																									
25008	2.50	14	8	2.2	4.2	Blue	27																																																																																																					
25010		16	10																																																																																																									
25012		18	12																																																																																																									
25018		24	18																																																																																																									

Model	Conductor cross sectional area (mm ²)	Dimensions (mm)				Color	Max. current (A)	Crimping plier
		L	B	Ø C	Ø D			
40010	4.00	17	10	2.8	4.8	Grey	37	YAC-6
40012		20	12					
40018		26	18					
60012	6.00	20	12	3.5	6.3	Green	48	
60018		26	18					
100012	10.0	22	12	4.5	7.6	Ivory	62	
100018		28	18					
160012	16.0	24	12	5.8	8.8	Green	88	
160018		28	18					
250016	25.0	28	16	7.3	11.2	Brown	115	
250018		30	18					
250022		35	22					
350012	35.0	26	12	8.3	12.7	Beige	160	
350016		30	16					
350018		32	18					
350025		39	25					
500020	50.0	36	20	10.3	15.0	Olive	215	
500025		40	25					
700021	70.0	37	21	13.5	16.0	Yellow	235	
950025	95.0	44	25	14.7	18.0	Red	255	
1200027	120.0	48	27	16.7	20.0	Blue	300	
1500032	150.0	58	32	19.5	23.0	Yellow	350	

◆ TVR/VF circular pre-insulated terminals

Figure D-2 TVR/VF circular pre-insulated terminal appearance and size



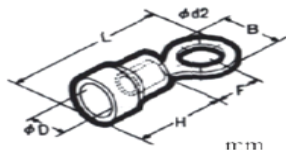

Table D-3 TVR/VF circular pre-insulated terminal size

Model	Wire diameter range		Ø D	H	F	B	Ø d2	L	Color	Max. current (A)	Crimping plier
	AWG/MCM	mm ²									
0.75-3	22-16	0.25-1.0	3.5	9.5	4.3	5.5	3.2	16.5	Red	10	YYT-1 YYT-7 2026NJ
0.75-4					6.6	8.0	4.3	20.0			
0.75-5					6.6	8.0	5.3	20.0			
1.25-3S	22-16	0.25-1.65	4.0	10.7	4.3	5.5	3.2	18.0	Red	19	
1.25-3					4.3	5.5	3.7	18.0			
1.25-3M1					6.6	6.6	3.2	20.9			
1.25-3M					6.6	6.6	3.7	20.9			
1.25-4					7.3	8.0	4.3	22.3			
1.25-4M					6.6	6.6	4.3	20.9			
1.25-5					7.3	8.0	5.3	22.3			
1.25-6					11.4	11.6	6.4	28.2			
1.25-8					11.4	11.6	8.4	28.2			
2-3					16-14	1.04-2.63	4.5	10.7			
2-3M	6.3	6.6	3.7	20.6							
2-4	7.75	8.5	4.3	23.0							
2-4M	6.3	6.6	4.3	20.6							
2-5	7.25	9.5	5.3	23.0							
2-6	11.0	12.0	6.4	27.4							
2-8	11.0	12.0	8.4	27.4							
2-10	13.9	13.6	10.5	31.7							
3.5-4	12-10	2.63-4.6	6.3	13.7	8.2	9.5	4.3	26.9	Yellow	37	
3.5-5					8.2	9.5	5.3	26.9			
3.5-6					8.5	12.0	6.4	28.3			
5.5-3	12-10	2.63-6.64	6.3	13.7	8.25	9.5	3.7	26.7	Yellow	48	
5.5-4					8.25	9.5	4.3	26.7			
5.5-5					8.25	9.5	5.3	26.7			

Model	Wire diameter range		Ø D	H	F	B	Ø d2	L	Color	Max. current (A)	Crimping plier
	AWG/MCM	mm ²									
5.5-6					13.0	12.0	6.4	32.7			
5.5-8					13.7	15.0	8.4	34.9			
5.5-10					13.7	15.0	10.5	34.9			

D.1.2 Control cable

Control cables mainly include analog signal control cables and digital signal control cables. Analog signal control cables use twisted double shielded cables (Figure a), with a separate shielded twisted pair for each signal and different ground wires for different analog signals. For digital signals, a double-shielded cable is preferred, but single-shielded or unshielded twisted pairs can also be used (Figure b).

Figure D-3 Control cable routing

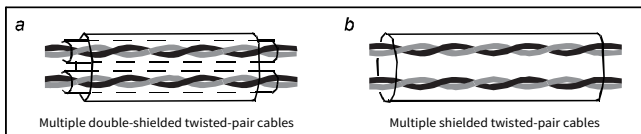

Note:

- Analog signal cables and communication cables must be independent shielded cables.
- The same cable cannot transmit 24V DC signals and 115/230V AC signals simultaneously.
- For frequency signals, only shielded cables can be used.
- A relay cable needs to carry the metal braided shield layer.
- For control cable wiring terminals, refer to the GTVE wiring terminal description in the wire lug model selection section.

D.2 Breaker and electromagnetic contactor

The circuit breaker is mainly used to prevent electric shock accidents and short circuits to the ground that may cause leakage current fire. The electromagnetic contactor is mainly used to control the main circuit power on and off, which can effectively cut off the input power of the VFD in case of system failure to ensure safety.

Table D-4 Fuse/breaker/contactor model selection

VFD model	Fuse (A)	Breaker (A)	Contactor rated current (A)
AC 1PH 200V-240V			
GD27-0R4G-S2-B-XX	10	10	9
GD27-0R7G-S2-B-XX	16	16	12
GD27-1R5G-S2-B-XX	20	20	18
GD27-2R2G-S2-B-XX	35	32	32
AC 3PH 200V-240V			
GD27-0R4G-2-B-EU	6	6	9
GD27-0R7G-2-B-EU	10	10	9
GD27-1R5G-2-B-EU	10	10	9
GD27-2R2G-2-B-EU	16	16	18
GD27-004G-2-B-EU	25	25	25
AC 3PH 380V-480V			
GD27-0R7G-4-B-XX	6	6	9
GD27-1R5G-4-B-XX	10	10	9
GD27-2R2G-4-B-XX	10	10	9
GD27-003G-4-B-XX	16	16	12
GD27-004G-4-B-XX	16	16	12
GD27-5R5G-4-B-XX	25	25	25
GD27-7R5G-4-B-XX	35	32	32

Note:

- -XX indicates empty or -EU.
- The accessory specifications described in the preceding table are ideal values. You can select accessories based on the site conditions, but try not to use those with lower values.

D.3 Optional parts

Reactors, filters, braking components, and mounting brackets are external accessories and need to be specifically specified when purchasing.

D.3.1 Reactor

A reactor is used to improve the power factor on the input side of the VFD, and thus restrict high-order harmonic currents.

Due to parasitic capacitance between the long cable and ground, the leakage current is large and the overcurrent protection of the VFD may be frequently triggered. To prevent this from happening and avoid damage to the motor insulator,

compensation must be made by adding an output reactor. For the length of the cable between the VFD and the motor, see A.5.1 Motor cable length for normal operation. If the length exceeds the limit, refer to the following table for selection; if the length exceeds twice the limit, consult us directly.

Table D-5 Reactor model selection

Model	Input reactor	Output reactor
GD27-0R4G-S2-B-XX	-	-
GD27-0R7G-S2-B-XX	-	-
GD27-1R5G-S2-B-XX	-	-
GD27-2R2G-S2-B-XX	-	-
GD27-0R4G-2-B-EU	ACL2-1R5-4	OCL2-1R5-4
GD27-0R7G-2-B-EU	ACL2-1R5-4	OCL2-1R5-4
GD27-1R5G-2-B-EU	ACL2-004-4	OCL2-004-4
GD27-2R2G-2-B-EU	ACL2-004-4	OCL2-004-4
GD27-004G-2-B-EU	ACL2-5R5-4	OCL2-5R5-4
GD27-0R7G-4-B-XX	ACL2-1R5-4	OCL2-1R5-4
GD27-1R5G-4-B-XX	ACL2-1R5-4	OCL2-1R5-4
GD27-2R2G-4-B-XX	ACL2-2R2-4	OCL2-2R2-4
GD27-003G-4-B-XX	ACL2-004-4	OCL2-004-4
GD27-004G-4-B-XX	ACL2-004-4	OCL2-004-4
GD27-5R5G-4-B-XX	ACL2-5R5-4	OCL2-5R5-4
GD20-7R5G-4-B-XX	ACL2-7R5-4	OCL2-7R5-4

Note:

- -XX indicates empty or -EU.
- The rated input voltage drop of input reactor is designed to 2%.
- The rated output voltage drop of output reactor is designed to 1%.

D.3.2 Filter

A filter is used to prevent the surrounding interference and prevent the interference from the VFD during running. Optional filters can be used to meet the conductivity and transmission requirements of CE/EN 61800-3 C2 electrical drive systems.

Table D-6 Filter model selection

Model	Input filter	Output filter
GD27-0R4G-S2-B-XX	FLT-PS2010H-B	FLT-L04006L-B
GD27-0R7G-S2-B-XX		
GD27-1R5G-S2-B-XX	FLT-PS2025L-B	FLT-L04016L-B
GD27-2R2G-S2-B-XX		

Model	Input filter	Output filter
GD27-0R4G-2-B-EU	FLT-P04006L-B	FLT-L04006L-B
GD27-0R7G-2-B-EU		
GD27-1R5G-2-B-EU	FLT-P04016L-B	FLT-L04016L-B
GD27-2R2G-2-B-EU		
GD27-004G-2-B-EU	FLT-P04032L-B	FLT-L04032L-B
GD27-0R7G-4-B-XX	FLT-P04006L-B	FLT-L04006L-B
GD27-1R5G-4-B-XX		
GD27-2R2G-4-B-XX		
GD27-003G-4-B-XX	FLT-P04016L-B	FLT-L04016L-B
GD27-004G-4-B-XX	FLT-P04016L-B	FLT-L04016L-B
GD27-5R5G-4-B-XX		
GD20-7R5G-4-B-XX	FLT-P04032L-B	FLT-L04032L-B

🔗**Note:** -XX indicates empty or -EU.

D.3.3 Braking component

The braking component includes braking resistors and braking units, which can be used to dissipate the regenerative energy generated by the motor, greatly improving braking and deceleration capabilities. When the VFD driving a high-inertia load decelerates or needs to decelerate abruptly, the motor runs in the power generation state and transmits the load-carrying energy to the DC circuit of the VFD, causing the bus voltage of the VFD to rise. If the bus voltage exceeds a specific value, the VFD reports an overvoltage fault. To prevent this from happening, you need to configure braking components.

Table D-7 Braking component model selection

Model	Braking unit	Resistance applicable for 100% braking torque (Ω)	Braking resistor dissipation power (kW) (10% braking usage)	Braking resistor dissipation power (kW) (50% braking usage)	Braking resistor dissipation power (kW) (80% braking usage)	Min. allowed braking resistance (Ω)
GD27-0R4G-S2-B-XX	Built-in braking unit	361	0.06	0.30	0.48	180
GD27-0R7G-S2-B-XX		192	0.11	0.56	0.90	100
GD27-1R5G-S2-B-XX		96	0.23	1.10	1.80	60
GD27-2R2G-S2-B-XX		65	0.33	1.70	2.64	39
GD27-0R4G-2-B-EU		361	0.06	0.3	0.48	180
GD27-0R7G-2-B-EU		192	0.11	0.56	0.9	100

Model	Braking unit	Resistance applicable for 100% braking torque (Ω)	Braking resistor dissipation power (kW) (10% braking usage)	Braking resistor dissipation power (kW) (50% braking usage)	Braking resistor dissipation power (kW) (80% braking usage)	Min. allowed braking resistance (Ω)
GD27-1R5G-2-B-EU		96	0.23	1.1	1.8	60
GD27-2R2G-2-B-XX		65	0.33	1.7	2.64	39
GD27-004G-2-B-XX		42	0.52	2.6	4.1	36
GD27-0R7G-4-B-XX		653	0.11	0.56	0.90	300
GD27-1R5G-4-B-XX		326	0.23	1.13	1.80	170
GD27-2R2G-4-B-XX		222	0.33	1.65	2.64	130
GD27-003G-4-B-XX		122	0.6	3	4.8	100
GD27-004G-4-B-XX		122	0.6	3	4.8	80
GD27-5R5G-4-B-XX		89.1	0.75	4.13	6.6	60
GD20-7R5G-4-B-XX		65	1.13	5.63	9	51

Note:

- -XX indicates empty or -EU.
- Select braking resistors according to the resistance and power data provided by INVT.
- The braking resistor may increase the braking torque of the VFD. The preceding table describes the resistance and power for 100% braking torque, 10% braking usage, 50% braking usage, and 80% braking usage. You can select the braking system based on the actual operation conditions.

D.3.4 Mounting bracket

D.3.4.1 Keypad structure

Figure D-4 Keypad external view

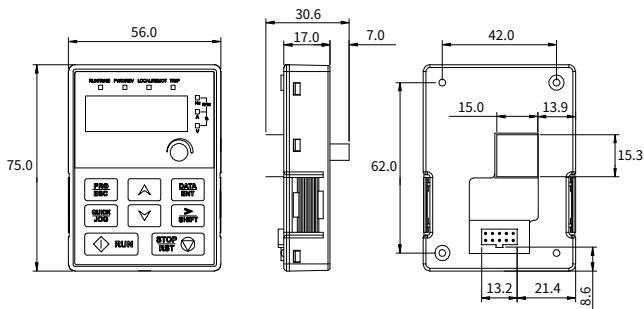
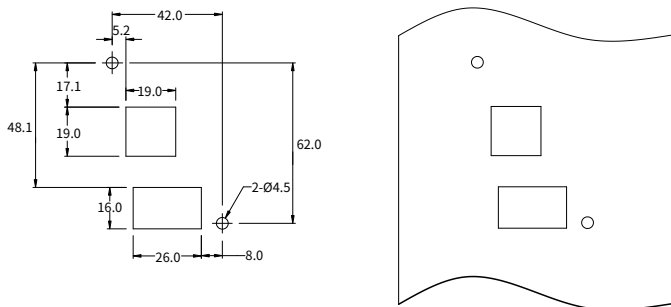

Figure D-5 Keypad openings without a bracket



Order No.	11022-00121 (Without keypad copying)	11022-00129 (With keypad copying)
Appearance		

D.3.4.2 Keypad mounting bracket

All models support external keypads that are optional.

You can mount the external keypad on a bracket. There are two types of brackets that are compatible with all keypads. Keypad mounting brackets are optional. Figure D-6 and Figure D-7 show the outline dimensions.

Figure D-6 Outline dimensions of keypad mounting bracket 1 (unit: mm)

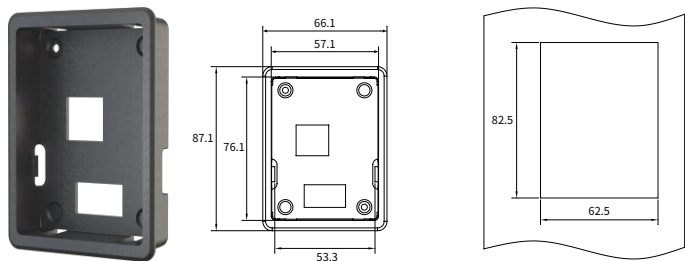

Name	Order No.
Keypad mounting bracket 1	61001-00090

Figure D-7 Outline dimensions of keypad mounting bracket 2 (unit: mm)

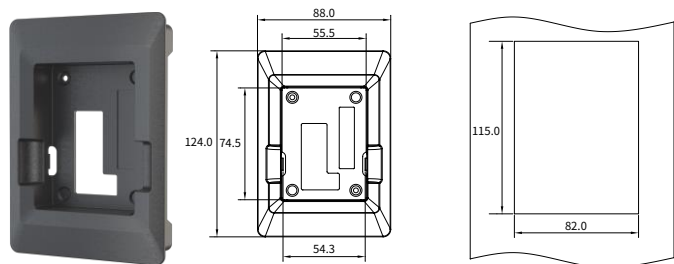

Name	Order No.
Keypad mounting bracket 2	11022-00136

D.3.4.3 DIN rail mounting bracket

When selecting the DIN rail mounting method for the models in frames A and B, you must select a rail mounting bracket.

Figure D-8 DIN rail mounting bracket dimensions (unit: mm)

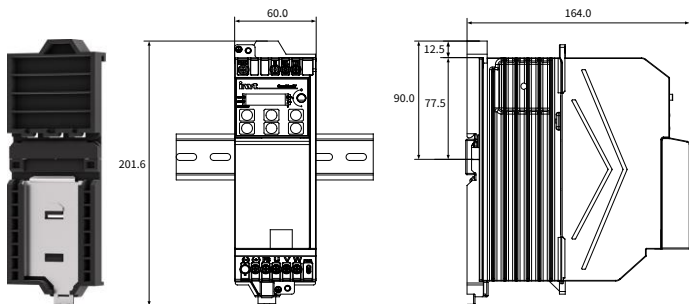

Name	Order No.
DIN rail mounting bracket	11091-00014

Appendix E STO function

Before starting the STO function, read the following content in detail and follow all safety precautions in this manual.

E.1 Safety standards

The product has been integrated with the STO function and complies with the following safety standards.

IEC 61000-6-7	Electromagnetic compatibility (EMC)—Part 7: General standards—Immunity requirements for equipment used in industrial sites to perform safety related functions (functional safety)
IEC 61326-3-1	EMC requirements for measurement, control, and laboratory electrical equipment—Part 31: Immunity requirements for safety related systems and equipment intended to perform safety related functions (functional safety)—General industrial applications
IEC 61508-1	Functional safety of electrical/electronic/programmable electronic safety related systems—Part 1: General requirements
IEC 61508-2	Functional safety of electrical/electronic/programmable electronic safety related systems—Part 2: Requirements for electrical/electronic/programmable electronic safety related systems
IEC/EN 61800-5-2	Speed regulation electrical transmission systems—Part 5-2: Safety requirements—Functions
IEC/EN 62061	Safety of machinery—Safety-related functional safety of electrical, electronic, and programmable electronic control systems
EN/ISO 13849-1	Safety of machinery—Safety related parts of control systems—Part 1: General principles for design
EN/ISO 13849-2	Safety of machinery—Safety related parts of control systems—Part 2: Verification

Safety standard related data is as follows.

Code	Definition	Standard	Characteristics
SIL	Safety integrity level	IEC 61508 IEC 62061	SIL 2

Code	Definition	Standard	Characteristics
PFH	Probability of failure per hour	IEC 61508	8.53×10^{-10}
HFT	Hardware fault tolerance	IEC 61508	1
SFF	Safe failure fraction	IEC 61508	99.39%
DC	Diagnosis coverage	ISO 13849-1	Greater than 90%
Cat.	Category	ISO 13849-1	3

E.2 Safety function description

■ STO function principle description

The Safe Torque Off (STO) function turns off the drive output by shutting down the drive signal, cutting off the electrical power supply to the motor and thus stopping the outward torque output (see Figure E-2). When STO is activated, this function prevents the motor from accidentally starting if the motor is in static state. If the motor is rotating, it will continue to rotate by inertia until it comes to rest. If the motor has a brake, the brake closes immediately.

Note:

- In normal working mode, you are not recommended to use the STO function to stop the VFD running. The STO function cannot effectively prevent sabotage or misuse. If the STO function is used to stop a running VFD, the VFD will disconnect the power supply to the motor, and the motor will coast to stop. If the consequences caused by this action are unacceptable, related stop modes should be used to stop the VFD and mechanical equipment.
- When using a permanent magnet, reluctance, or nonsalient pole induction motor, even if the STO function is activated, there is still a possible failure mode (although the possibility is very low) that prevents the two power devices of the VFD from conducting. The drive system can output a uniform torque, which can rotate the permanent magnet motor shaft by a maximum electrical angle of 180° , or the nonsalient pole induction motor or reluctance motor shaft by an electrical angle of 90° . This possible failure mode must be allowed during the design of the machine system. Maximum motor shaft rotation angle = Electrical angle of 360° / Number of motor pole pairs.
- The STO function cannot replace the emergency stop function. When no other measures are taken, the power supply of the VFD cannot be cut off in an emergency.
- The STO function has priority over all other functions of the VFD.
- Although the STO function can reduce known hazardous conditions, it does not eliminate all potential hazards.
- Designing safety related systems requires professional safety knowledge. To ensure the safety of a complete control system, design the system according to

the required safety principles. A single subsystem with the STO function, although intentionally designed for safety related applications, it cannot guarantee the safety of the entire system.

■ Emergency stop function description

When the emergency stop function is used in equipment, it mainly allows operators to take timely actions to prevent accidents in unexpected conditions. Its design may not necessarily be complex or intelligent, but it may use simple electromechanical devices to initiate a controlled rapid stop by cutting off the power supply or other means (such as dynamic or regenerative braking).

E.3 Risk assessment

1. Before using the STO function, a risk assessment needs to be conducted on the drive system to ensure compliance with the required safety standards.
2. There may also be some other risks when the device is operating with safety functions. Therefore, safety must always be considered when conducting risk assessments.
3. If an external force (such as vertical axis gravity) is applied while the safety function is in operation, the motor will rotate. A separate mechanical brake must be provided to secure the motor.
4. If the drive fails, the motor can operate within the range of 180 degrees, ensuring safety even in dangerous situations.
5. The rotation number and moving distance of each type of motor are as follows:
 - Rotating motor: can rotate up to 1/6 (of the motor shaft rotation angle).
 - Drive motor: can rotate up to 1/20 (of the motor shaft rotation angle).
 - Linear servo motor: can move up to 30mm.

E.4 STO wiring

In the factory, the STO function terminals +24V, H1, and H2 have been shorted.

The wiring requirements are as follows:

1. When using the STO function of the VFD, remove the jumpers between +24V and H1 and between +24V and H2.
2. When the VFD is in normal operation, close the switches or relays.

Figure E-1 Shorting +24V to H1 and to H2

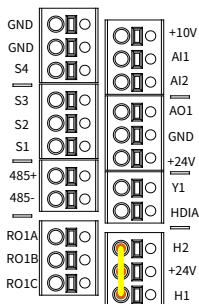
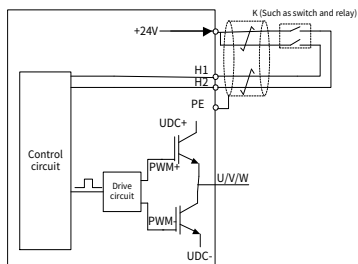

Figure E-2 STO function circuit wiring



 **Note:**

- The symbol "K" in the preceding figure can represent components such as manual operation switch, emergency stop switch, safety relay, and safety PLC contact.
- The opening or closing of safety switch contact must be within 200ms.
- The maximum length of the double-shielded twisted pair cable between the VFD and safety switch is 25m.
- The cable shield layer should be connected to the PE terminal of the VFD.
- When the STO function is enabled, the switch or relay is opened. If the VFD stops output, the keypad displays "E40".

E.5 STO function terminal description

STO function terminals are listed in the following table.

Terminal	Function
+24V	Voltage range: 24V±15% To disable the STO function, short +24V to H1 and to H2.
H1	Voltage in STO action mode: 0V < H1 and H2 < 5V Voltage in STO cut-off mode: 13V < H1 and H2 < 30V
H2	Input current: 5mA STO function channel signal input

E.6 STO function logic table

The function logics of H1 and H2 and keypad display are listed in the following table.

H1	H2	VFD status	Keypad display	Fault description
H1 closed	H2 closed	Normal running	No exception displayed	-
H1 opened	H2 opened	Torque output off	E40	STO
H1 opened	H2 closed	Torque output off	E41	H1 is abnormal.
H1 closed	H2 opened	Torque output off	E42	H2 is abnormal.

 **Note:** E43 indicates both H1 and H2 are abnormal.

E.7 STO channel delay description

The following table describes the trigger and indication delay of the STO channels.

Table E-1 lists the STO channel trigger and indication delay

STO mode	STO trigger delay ¹ and indication delay ²
STO fault: E41	Trigger delay < 10ms Indication delay < 280ms
STO fault: E42	Trigger delay < 10ms Indication delay < 280ms
STO fault: E43	Trigger delay < 10ms Indication delay < 280ms
STO fault: E40	Trigger delay < 10ms Indication delay < 100ms

1: STO trigger delay: time interval between trigger the STO function and switching off the drive output

2: STO instruction delay: time interval between trigger the STO function and STO output state indication

E.8 Acceptance test

Warning	
	<ul style="list-style-type: none"> • Technical personnel, operators, maintenance and repair personnel must receive relevant training to understand the requirements and principles of safety system design and debugging. • Do not carry out maintenance on the VFD or motor before the power is cut off; otherwise, there may be a risk of electric shock or other electricity generated hazards. • The safety function acceptance test must be carried out by personnel with professional safety function knowledge, and must be recorded and signed by test engineers.

The acceptance test must be carried for the device in the following stages:

1. First starting of safety functions
2. After any safety function related change (including PCB, wiring, component, or setup)
3. After any safety function related maintenance work

The signed acceptance test report must be kept in machine logs. The report should include the documents of startup activities and test results, fault report references and fault solutions. Any new acceptance test conducted due to changes or maintenance should be recorded in the logs.

■ Acceptance test checklist

Step	Test	Result
1	Ensure that the VFD can run or stop randomly during commissioning.	
2	Stop the VFD (if it is running), disconnect the input power supply, and isolate the drive from the power cable through the isolation switch.	
3	Check the STO function circuit connection according to the circuit diagram.	
4	<p>Close the isolation switch to connect to the power.</p> <p>Test the STO function as follows when the motor stops: If the VFD is running, send a stop command to it and wait until the motor shaft stops rotating. Disconnect the STO circuit. Then the VFD should enter the safe torque off mode and stop outputting voltage, and the keypad displays "E40". Send a VFD startup command, but the motor does not start.</p>	

Step	Test	Result
	<p>Close the STO circuit. Remove the fault, start the VFD, and ensure that the motor can run properly.</p>	
	<p>Test the STO function as follows when the motor is running: Start the VFD and ensure that the motor runs. Disconnect the STO circuit. Then the VFD should enter the safe torque off mode and stop outputting voltage, and the keypad displays "E40". The motor should stop. Remove the fault, start the VFD, and ensure that the motor keeps the static state. Close the STO circuit. Remove the fault, start the VFD, and ensure that the motor can run properly.</p>	
5	<p>Test and detect the VFD fault. At this time, the motor can be in running or stopped state. Start the VFD and ensure that the motor runs properly. Disconnect H1 and keep H2 closed. If the motor is running, it should coast to stop, and the keypad displays "E41". Send a VFD startup command, but the motor does not start. Close the STO circuit. At this time, the fault cannot be removed. Power off and restart the VFD, and ensure that the motor can run properly. Disconnect H2 and keep H1 closed. If the motor is running, it should coast to stop, and the keypad displays "E42". Send a VFD startup command, but the motor does not start. Close the STO circuit. At this time, the fault cannot be removed. Power off and restart the VFD, and ensure that the motor can run properly.</p>	
6	<p>Record and sign the acceptance test report, which indicates the STO function is safe and can be put into service.</p>	

 **Note:**

- If the steps in the acceptance test checklist can be carried out normally without other exceptions, it indicates that the STO functional circuit is normal. If the situations are different from the expected results of the preceding steps or if "E43" is displayed, it indicates that the STO function circuit is abnormal. For details about fault handling, see 8.2 Faults and solutions.
- Fault "E40" can also be manually or automatically reset by setting P08.52.

VFD in fault	Fault code displayed	Response time	Reset method
Normal running	No exception displayed	/	/
Torque output off	E40	$\leq 20\text{ms}$	Press STOP/RST .
Torque output off	E41	$\leq 20\text{ms}$	Entire machine re-powered on
Torque output off	E42	$\leq 20\text{ms}$	Entire machine re-powered on

Appendix F Function parameter list

The function parameters of the VFD are divided into groups by function. Among the function parameter groups, the P28 group is the analog input and output calibration group, while the P29 group contains the factory function parameters, which are user inaccessible. Each group includes several function codes (each function code identifies a function parameter). A three-level menu style is applied to function codes. For example, "P08.08" indicates the 8th function code in the P08 group. The VFD supplies the password protection function. For detail settings, see P07.00. The parameters adopt the decimal system (0–9) and hexadecimal system (0–F). If the hexadecimal system is adopted, all bits are mutually independent on data during parameter editing. The symbols in the table are described as follows:

"○" indicates that the value of the parameter can be modified when the VFD is in stopped or running state.

"⊙" indicates that the value of the parameter cannot be modified when the VFD is in running state.

"●" indicates that the value of the parameter is detected and recorded, and cannot be modified. (When "Restore factory settings" is performed, the actual detected parameter values or recorded values will not be restored.)

Group P00—Basic functions

Function code	Name	Description	Default	Modify
P00.00	Speed control mode	Specifies a speed control mode. Setting range: 0–2 0: SVC 0 1: SVC 1 2: Space voltage vector control mode  Note: Before using a vector control mode (0 or 1), enable the VFD to perform motor parameter autotuning first.	2	⊙
P00.01	Channel of running commands	Specifies a channel of running commands. Setting range: 0–2 0: Keypad 1: Terminal 2: Communication	0	○

Function code	Name	Description	Default	Modify
P00.02	Reserved	-	-	-
P00.03	Max. output frequency	Specifies the max. output frequency of the VFD, which is the basis of the frequency setting and the acceleration (ACC) and deceleration (DEC) speed. Setting range: P00.04–599.00Hz	50.00Hz	☉
P00.04	Upper limit of running frequency	Specifies the upper limit of the VFD output frequency, which should be smaller than or equal to the max. output frequency. If the set frequency is higher than the upper limit of the running frequency, the upper limit of the running frequency is used for running. Setting range: P00.05–P00.03 (Max. output frequency)	50.00Hz	☉
P00.05	Lower limit of running frequency	Specifies the lower limit of the VFD output frequency. If the set frequency is lower than the lower limit of the running frequency, the lower limit of the running frequency is used for running. Setting range: 0.00Hz–P00.04 (Upper limit of running frequency)  Note: Max. output frequency \geq Upper limit of frequency \geq Lower limit of frequency	0.00Hz	☉
P00.06	Setting channel of A frequency command	Specifies the frequency command source. Setting range: 0–8 0: Keypad digital 1: AI1	0	○
P00.07	Setting channel of B frequency command	2: AI2 3: AI3 4: High-speed pulse HDIA 5: Simple PLC program	1	○

Function code	Name	Description	Default	Modify
		6: Multi-step speed running 7: PID control 8: Modbus communication		
P00.08	Reference object of B frequency command	Specifies the reference object of B frequency command. Setting range: 0–1 0: Max. output frequency 1: A frequency command	0	<input type="radio"/>
P00.09	Combination mode of setting source	Specifies the combination mode of A/B frequency setting source. Setting range: 0–5 0: A 1: B 2: (A+B) 3: (A-B) 4: Max(A, B) 5: Min(A, B)	0	<input type="radio"/>
P00.10	Setting frequency through the keypad	Specifies the initial VFD frequency set value when A and B frequency commands are set by keypad. Setting range: 0.00Hz–P00.03 (Max. output frequency)	50.00Hz	<input type="radio"/>
P00.11	ACC time 1	Specifies the ACC time of ramp frequency. Setting range: 0.0–3600.0s	Model depended	<input type="radio"/>
P00.12	DEC time 1	Specifies the DEC time of ramp frequency. Setting range: 0.0–3600.0s	Model depended	<input type="radio"/>
P00.13	Running direction	Specifies the running direction. Setting range: 0–2 0: Run in default direction 1: Run in reverse direction 2: Disable reverse running	0	<input type="radio"/>
P00.14	Carrier frequency setting	Specifies the carrier frequency. A high carrier frequency will have an ideal current waveform, few current harmonics, and small motor noise,	Model depended	<input type="radio"/>

Function code	Name	Description	Default	Modify
		<p>but it will increase the switch loss, increase VFD temperature, and impact the output capacity. At the same time, the VFD current leakage and electrical magnetic interference will increase. On the contrary, an extremely-low a carrier frequency may cause unstable operation at low frequency, decrease the torque, or even lead to oscillation.</p> <p>The carrier frequency has been properly set in the factory before the VFD is delivered. In general, you do not need to modify it.</p> <p>The mapping between VFD models and default carrier frequency values is as follows: For 380V 0.75kW and higher: 4kHz For other models: 8kHz Setting range: 1.0–15.0kHz</p> <p> Note: When the frequency used exceeds the default carrier frequency, the VFD needs to derate by 10% for each increased of 1kHz.</p>		
P00.15	Motor parameter autotuning	<p>Specifies the motor autotuning function.</p> <p>Setting range: 0–3</p> <p>0: No operation 1: Rotary autotuning 1 2: Static autotuning 1 (comprehensive) 3: Static autotuning 2 (Partial autotuning)</p>	0	<input checked="" type="radio"/>
P00.16	AVR function selection	<p>Specifies the VFD automatic voltage regulation (AVR) function, which can eliminate the impact of the bus voltage fluctuation on the VFD</p>	1	<input type="radio"/>

Function code	Name	Description	Default	Modify
		output voltage. Setting range: 0–1 0: Disable 1: Valid during the whole procedure		
P00.17	Reserved	-	-	-
P00.18	Function parameter restoration	Specifies the function parameter restoration. Setting range: 0–3 0: No operation 1: Restore to default values (excluding motor parameters) 2: Clear fault records 3: Lock all function codes  Note: Restoring to default values will delete the user password. After the selected operation is performed, the function code is automatically restored to 0. When it is set to 3 (Lock all function codes), the value of any function code cannot be modified.	0	⊙

Group P01—Start and stop control

Function code	Name	Description	Default	Modify
P01.00	Start mode	Specifies the start mode. Setting range: 0–1 0: Direct start 1: Start after DC braking	0	⊙
P01.01	Starting frequency of direct start	Specifies the initial frequency during VFD start. Setting range: 0.00–50.00Hz	0.50Hz	⊙
P01.02	Hold time of starting frequency	Specifies the hold time of starting frequency. Setting range: 0.0–50.0s	0.0s	⊙
P01.03	Braking current before start	Specifies the DC braking current before startup. Setting range: 0.0–100.0%	0.0%	⊙

Function code	Name	Description	Default	Modify
P01.04	Braking time before start	Specifies the DC braking time before startup. Setting range: 0.00–50.00s	0.00s	<input checked="" type="radio"/>
P01.05	ACC/DEC mode	Specifies the changing mode of the frequency during start and running. Setting range: 0–1 0: Linear type. The output frequency increases or decreases linearly. 1: S curve. The output frequency increases or decreases according to the S curve.  Note: The S curve is generally applied to elevators, conveyors, and other application scenarios where smoother start or stop is required. When S curve mode is selected, P01.06, P01.07, P01.27, and P01.28 need to be set accordingly.	0	<input checked="" type="radio"/>
P01.06	Time of starting segment of ACC S curve	Specifies the time of the starting segment of the ACC S curve. It works with P01.07 to determine the curvature of the S curve. Setting range: 0.0–50.0s	0.1s	<input checked="" type="radio"/>
P01.07	Time of ending segment of ACC S curve	Specifies the time of the ending segment of the ACC S curve. It works with P01.06 to determine the curvature of the S curve. Setting range: 0.0–50.0s	0.1s	<input checked="" type="radio"/>
P01.08	Stop mode	Specifies the stop mode. Setting range: 0–1 0: Decelerate to stop. After a stop command takes effect, the VFD lowers output frequency based on the DEC mode and the defined DEC time; after the frequency drops to the stop speed (P01.15), the VFD stops.	0	<input type="radio"/>

Function code	Name	Description	Default	Modify
		1: Coast to stop. After a stop command takes effect, the VFD ceases the output immediately, and the load coasts to stop according to mechanical inertia.		
P01.09	Starting frequency of DC braking for stop	Specifies the starting frequency of DC braking for stop. Setting range: 0.00Hz–P00.03 (Max. output frequency)	0.00Hz	<input type="radio"/>
P01.10	Demagnetization time	Specifies the demagnetization time, that is, the wait time before DC braking for stop. Setting range: 0.00–30.00s	0.00s	<input type="radio"/>
P01.11	DC braking current for stop	Specifies the DC braking current for stop, that is, the DC braking energy. Setting range: 0.0–100.0% (of the rated VFD output current)	0.0%	<input type="radio"/>
P01.12	DC braking time for stop	Specifies the duration of DC braking. Setting range: 0.00–50.00s  Note: If the value is 0, DC braking is invalid, and the VFD decelerates to stop within the specified time.	0.00s	<input type="radio"/>
P01.13	FWD/REV running deadzone time	Specifies the transition time of the switching in FWD/REV running switching mode specified by P01.14. Setting range: 0.0–3600.0s	0.0s	<input type="radio"/>
P01.14	FWD/REV running switching mode	Specifies the forward/reverse running switching mode. Setting range: 0–2 0: Switch at zero frequency 1: Switch at the starting frequency 2: Switch after the speed reaches the stop speed with a delay	1	<input checked="" type="radio"/>

Function code	Name	Description	Default	Modify
P01.15	Stop speed	Specifies the stop speed (frequency). Setting range: 0.00–100.00Hz	0.50Hz	☉
P01.16	Stop speed detection mode	Specifies the stop speed detection mode. The VFD stops when the value in the selected mode is less than P01.15. Setting range: 0–1 0: Detect by the set speed (unique in space voltage vector control mode) 1: Detect by the feedback speed	1	☉
P01.17	Stop speed detection time	Specifies the stop speed detection time. Setting range: 0.00–100.00s	0.00s	☉
P01.18	Terminal-based running command protection at power-on	Specifies whether the terminal running command is valid at power-on. Setting range: 0–1 0: The terminal running command is invalid at power-on. 1: The terminal running command is valid at power-on.	0	○
P01.19	Action selected when running frequency less than frequency lower limit (valid when frequency lower limit greater than 0)	Specifies the run status of the VFD when the set frequency is below the lower limit. Setting range: 0x00–0x12 Ones place: Action selection 0: Run at the frequency lower limit 1: Stop 2: Sleep Tens place: Stop mode 0: Coast to stop 1: Decelerate to stop	0x00	☉
P01.20	Wake-up-from-sleep delay	Specifies the wake-up-from-sleep delay time. Setting range: 0.0–3600.0s (Valid	0.0s	○

Function code	Name	Description	Default	Modify
		only when the ones place of P01.19 is 2.)		
P01.21	Restart after power off	Specifies whether the VFD automatically runs after re-power on. Setting range: 0–1 0: Disable 1: Enable. If the restart condition is met, the VFD will run automatically after waiting the time defined by P01.22.	0	<input type="radio"/>
P01.22	Wait time for restart after power-off	Specifies the wait time before the automatic running of the VFD that is re-powered on. Setting range: 0.0–3600.0s (valid only when P01.21 = 1)	1.0s	<input type="radio"/>
P01.23	Start delay	Setting range: 0.0–600.0s	0.0s	<input type="radio"/>
P01.24	Stop speed delay	Setting range: 0.0–600.0s	0.0s	<input type="radio"/>
P01.25	Open-loop 0Hz output selection	Setting range: 0–2 0: Output without voltage 1: Output with voltage 2: Output with the DC braking current for stop	0	<input type="radio"/>
P01.26	DEC time for emergency stop	Setting range: 0.0–60.0s	2.0s	<input type="radio"/>
P01.27	Time of starting segment of DEC S curve	Setting range: 0.0–50.0s	0.1s	<input checked="" type="radio"/>
P01.28	Time of ending segment of DEC S curve	Setting range: 0.0–50.0s	0.1s	<input checked="" type="radio"/>
P01.29	Short-circuit braking current	Setting range: 0.0–150.0% (of the rated VFD output current)	0.0%	<input type="radio"/>

Function code	Name	Description	Default	Modify
P01.30	Hold time of short-circuit braking for start	When the VFD starts in direct start mode (P01.00 = 0), set P01.30 to a non-zero value to enter short-circuit braking. Setting range: 0.00–50.00s	0.00s	<input type="radio"/>
P01.31	Hold time of short-circuit braking for stop	During stop, if the running frequency of VFD is lower than the starting frequency of brake for stop (P01.09), set P01.31 to a non-zero value to enter short-circuit braking for stop, and then carry out DC braking in the time specified by P01.12. (See descriptions for P01.09–P01.12.) Setting range: 0.00–50.00s	0.00s	<input type="radio"/>
P01.32	Pre-exciting time for jogging	Setting range: 0.000–10.000s	0.300s	<input type="radio"/>
P01.33	Starting frequency of braking for stop in jogging	Setting range: 0.00Hz–P00.03 (Max. output frequency)	0.00Hz	<input type="radio"/>
P01.34	Sleep delay	Setting range: 0–3600.0s	0.0s	<input type="radio"/>

Group P02—Parameters of motor 1

Function code	Name	Description	Default	Modify
P02.00	Type of motor 1	Setting range: 0–1 0: Asynchronous motor (AM) 1: Synchronous motor (SM)	0	<input checked="" type="radio"/>
P02.01	Rated power of AM 1	Setting range: 0.1–3000.0kW	Model depended	<input checked="" type="radio"/>
P02.02	Rated frequency of AM 1	Setting range: 0.01Hz–P00.03 (Max. output frequency)	50.00Hz	<input checked="" type="radio"/>







Function code	Name	Description	Default	Modify
P02.03	Rated speed of AM 1	Setting range: 1–60000rpm	Model depended	<input checked="" type="radio"/>
P02.04	Rated voltage of AM 1	Setting range: 0–1200V	Model depended	<input checked="" type="radio"/>
P02.05	Rated current of AM 1	Setting range: 0.08–600.00A	Model depended	<input checked="" type="radio"/>
P02.06	Stator resistance of AM 1	Setting range: 0.001–65.535Ω	Model depended	<input type="radio"/>
P02.07	Rotor resistance of AM 1	Setting range: 0.001–65.535Ω	Model depended	<input type="radio"/>
P02.08	Leakage inductance of AM 1	Setting range: 0.1–6553.5mH	Model depended	<input type="radio"/>
P02.09	Mutual inductance of AM 1	Setting range: 0.1–6553.5mH	Model depended	<input type="radio"/>
P02.10	No-load current of AM 1	Setting range: 0.01–655.35A	Model depended	<input type="radio"/>
P02.11	Magnetic saturation coefficient 1 of iron core of AM 1	Setting range: 0.0–100.0%	80.0%	<input type="radio"/>
P02.12	Magnetic saturation coefficient 2 of iron core of AM 1	Setting range: 0.0–100.0%	68.0%	<input type="radio"/>
P02.13	Magnetic saturation coefficient 3 of iron core of AM 1	Setting range: 0.0–100.0%	57.0%	<input type="radio"/>

Function code	Name	Description	Default	Modify
P02.14	Magnetic saturation coefficient 4 of iron core of SM 1	Setting range: 0.0–100.0%	40.0%	<input type="radio"/>
P02.15	Rated power of SM 1	Setting range: 0.1–3000.0kW	Model depended	<input checked="" type="radio"/>
P02.16	Rated frequency of SM 1	Setting range: 0.01Hz–P00.03 (Max. output frequency)	50.00Hz	<input checked="" type="radio"/>
P02.17	Number of pole pairs of SM 1	Setting range: 1–128	2	<input checked="" type="radio"/>
P02.18	Rated voltage of SM 1	Setting range: 0–1200V	Model depended	<input checked="" type="radio"/>
P02.19	Rated current of SM 1	Setting range: 0.08–600.00A	Model depended	<input checked="" type="radio"/>
P02.20	Stator resistance of SM 1	Setting range: 0.001–65.535Ω	Model depended	<input type="radio"/>
P02.21	Direct-axis inductance of SM 1	Setting range: 0.01–655.35mH	Model depended	<input type="radio"/>
P02.22	Quadrature-axis inductance of SM 1	Setting range: 0.01–655.35mH	Model depended	<input type="radio"/>
P02.23	Counter-emf constant of SM 1	Setting range: 0–10000	300	<input type="radio"/>
P02.24	Initial pole position of SM 1	Setting range: 0x0000–0xFFFF	0x0000	<input checked="" type="radio"/>
P02.25	Identification current of SM 1	Setting range: 0–50%	10%	<input checked="" type="radio"/>
P02.26	Overload protection	Setting range: 0–2 0: No protection	2	<input checked="" type="radio"/>



Function code	Name	Description	Default	Modify
	selection of motor 1	1: Common motor (with low-speed compensation) As the cooling effect of a common motor is degraded at low speed running, the corresponding electronic thermal protection value needs to be adjusted properly, the low compensation indicates lowering the overload protection threshold of the motor whose running frequency is lower than 30Hz. 2: Frequency-variable motor (without low-speed compensation) The heat dissipation function for a variable-frequency motor is not impacted by the rotation speed, and therefore it is not necessary to adjust the protection value at low speed running.		
P02.27	Overload protection coefficient of motor 1	Specifies the motor overload protection coefficient. A small motor overload protection coefficient indicates a great overload multiplication (M). When M=116%, protection is performed after motor overload lasts for 1 hour; when M=150%, protection is performed after motor overload lasts for 12 minutes; when M=200%, protection is performed after motor overload lasts for 60 seconds; and when $M \geq 400\%$, protection is performed immediately. Setting range: 20.0%–150.0%	100.0%	<input type="radio"/>
P02.28	Power display calibration	Used to adjust the power display value of motor 1. However, it does	1.00	<input type="radio"/>





Function code	Name	Description	Default	Modify
	coefficient of motor 1	not affect the control performance of the VFD. Setting range: 0.00–3.00		
P02.29	Parameter display of motor 1	Setting range: 0–1 0: Display by motor type. In this mode, only parameters related to the present motor type are displayed. 1: Display all. In this mode, all the motor parameters are displayed.	0	○
P02.30	System inertia of motor 1	Setting range: 0.000–30.000kgm ²	0.000 kgm ²	○
P02.31–P02.32	Reserved	-	-	-

Group P03—Vector control of motor 1

Function code	Name	Description	Default	Modify
P03.00	Speed-loop proportional gain 1	Setting range: 0.0–200.0  Note: Applicable only to vector control mode.	20.0	○
P03.01	Speed-loop integral time 1	Setting range: 0.000–10.000s  Note: Applicable only to vector control mode.	0.200s	○
P03.02	Low-point frequency for switching	Setting range: 0.00Hz–P03.05  Note: Applicable only to vector control mode.	5.00Hz	○
P03.03	Speed-loop proportional gain 2	Setting range: 0.0–200.0  Note: Applicable only to vector control mode.	20.0	○
P03.04	Speed-loop integral time 2	Setting range: 0.000–10.000s  Note: Applicable only to vector control mode.	0.200s	○
P03.05	High-point frequency for switching	Setting range: P03.02–P00.03 (Max. output frequency)  Note: Applicable only to vector	10.00 Hz	○

Function code	Name	Description	Default	Modify
		control mode.		
P03.06	Speed-loop output filter	0–8 (corresponding to 0–2 ⁸ /10ms)	0	<input type="radio"/>
P03.07	Electromotive slip compensation coefficient of vector control	Slip compensation coefficient is used to adjust the slip frequency of the vector control and improve the speed control accuracy of the system. Adjusting the parameter properly can control the speed steady-state error. Setting range: 50–200%	100%	<input type="radio"/>
P03.08	Power-generation slip compensation coefficient of vector control	Slip compensation coefficient is used to adjust the slip frequency of the vector control and improve the speed control accuracy of the system. Adjusting the parameter properly can control the speed steady-state error. Setting range: 50–200%	100%	<input type="radio"/>
P03.09	Reserved	-	-	-
P03.10	Current-loop band width	Setting range: 0–2000  Note: <ul style="list-style-type: none"> ● P03.10 is a current loop PI regulation parameter. It impacts the dynamic response speed and control accuracy of the system. Generally, you do not need to modify it. ● Applicable to SVC 0 (P00.00 = 0) and SVC 1 (P00.00 = 1). 	400	<input type="radio"/>
P03.11	Torque setting method	Setting range: 0–7 0–1: Keypad (P03.12) 2: AI1 3: AI2 4: AI3 5: Pulse frequency HDIA 6: Multi-step torque	0	<input type="radio"/>

Function code	Name	Description	Default	Modify
		7: Modbus communication  Note: For AMs, 100% corresponds to the motor rated torque current (when the value 0 or 1 is selected) and 100% corresponds to triple the motor rated torque current (when the value from 2 to 7 is selected). For SMs, 100% corresponds to the motor rated current (when the value 0 or 1 is selected) and 100% corresponds to triple the motor rated current (when the value from 2 to 7 is selected).		
P03.12	Torque set through keypad	Setting range: -300.0%–300.0% (of the motor rated current)  Note: For AMs, 100% corresponds to the motor rated torque current. For SMs, 100% corresponds to the motor rated current.	20.0%	<input type="radio"/>
P03.13	Torque reference filter time	Setting range: 0.000–10.000s	0.010s	<input type="radio"/>
P03.14	Setting source of forward rotation frequency upper limit in torque control	Setting range: 0–6 0: Keypad (P03.16) 1: AI1 2: AI2 3: AI3 4: Pulse frequency HDIA 5: Multi-step setting 6: Modbus communication  Note: 100% corresponds to the max. frequency.	0	<input type="radio"/>

Function code	Name	Description	Default	Modify
P03.15	Setting source of reverse rotation frequency upper limit in torque control	Setting range: 0-6 0: Keypad (P03.17) 1: AI1 2: AI2 3: AI3 4: Pulse frequency HDIA 5: Multi-step setting 6: Modbus communication  Note: 100% corresponds to the max. frequency.	0	<input type="radio"/>
P03.16	Forward rotation frequency upper limit set through keypad in torque control	Specifies the frequency limit when P03.14 = 0. Setting range: 0.00Hz-P00.03 (Max. output frequency)  Note: 100% corresponds to the max. frequency.	50.00Hz	<input type="radio"/>
P03.17	Reverse rotation frequency upper limit set through keypad in torque control	Specifies the frequency limit when P03.15 = 0. Setting range: 0.00Hz-P00.03 (Max. output frequency)  Note: 100% corresponds to the max. frequency.	50.00Hz	<input type="radio"/>
P03.18	Setting source of electromotive torque upper limit	Setting range: 0-5 0: Keypad (P03.20) 1: AI1 2: AI2 3: AI3 4: Pulse frequency HDIA 5: Modbus communication  Note: For AMS, 100% corresponds to the motor rated torque current (when the value 0 is selected) and 100% corresponds to triple the motor rated torque current (when the value from 1 to 5 is selected). For	0	<input type="radio"/>

Function code	Name	Description	Default	Modify
		SMS, 100% corresponds to the motor rated current (when the value 0 or 1 is selected) and 100% corresponds to triple the motor rated current (when the value from 2 to 5 is selected).		
P03.19	Setting source of braking torque upper limit	Setting range: 0-5 0: Keypad (P03.21) 1: AI1 2: AI2 3: AI3 4: Pulse frequency HDIA 5: Modbus communication  Note: For AMs, 100% corresponds to the motor rated torque current (when the value 0 is selected) and 100% corresponds to triple the motor rated torque current (when the value from 1 to 5 is selected). For SMS, 100% corresponds to the motor rated current (when the value 0 or 1 is selected) and 100% corresponds to triple the motor rated current (when the value from 2 to 5 is selected).	0	<input type="radio"/>
P03.20	Electromotive torque upper limit set through keypad	Specifies the torque limit when P03.18 = 0. Setting range: 0.0-300.0% (For AMs, 100% corresponds to the motor rated torque current; for SMS, 100% corresponds to the motor rated current.)	180.0%	<input type="radio"/>
P03.21	Braking torque upper limit set through keypad	Specifies the torque limit when P03.19 = 0. Setting range: 0.0-300.0% (For AMs, 100% corresponds to the motor rated torque current; for SMS, 100%	180.0%	<input type="radio"/>







Function code	Name	Description	Default	Modify
		corresponds to the motor rated current.)		
P03.22	Weakening coefficient in constant power zone	Used when the AM is in flux-weakening control. Setting range: 0.0–200.0%	100.0%	<input type="radio"/>
P03.23	Lowest weakening point in constant power zone	Setting range: 5%–100%	5%	<input type="radio"/>
P03.24	Max. voltage limit	Specifies the max. VFD output voltage, which is a percentage of the motor rated voltage. Set the value according to onsite conditions. Setting range: 0.0–120.0%	100.0%	<input type="radio"/>
P03.25	Pre-exciting time	Specifies the pre-exciting time. Pre-exciting is performed for the motor when the VFD starts up. A magnetic field is built up inside the motor to improve the torque performance during the start process. Setting range: 0.000–10.000s	0.300s	<input type="radio"/>
P03.26	Flux-weakening proportional gain	Setting range: 0–8000	1000	<input type="radio"/>
P03.27	Speed display selection in vector control	Setting range: 0–1 0: Display the actual value 1: Display the set value	0	<input type="radio"/>
P03.28	Static friction compensation coefficient	Setting range: 0.0–100.0%	0.0%	<input type="radio"/>
P03.29	Corresponding frequency point of static	Setting range: 0.50–P03.31	1.00Hz	<input type="radio"/>

Function code	Name	Description	Default	Modify
	friction			
P03.30	High speed friction compensation coefficient	Setting range: 0.0–100.0%	0.0%	○
P03.31	Corresponding frequency of high speed friction torque	Setting range: P03.29–P00.03 (Max. output frequency)	50.00Hz	○
P03.32	Enabling torque control	Setting range: 0–1 0: Disable 1: Enable	0	○
P03.33	Flux-weakening integral gain	Setting range: 0.0–300.0%	30.0%	○
P03.34	Reserved	-	-	-
P03.35	Control mode optimization selection	Setting range: 0x0000–0x1111 Ones place: Torque command selection 0: Torque reference 1: Torque current reference Tens place: Reserved 0: Reserved 1: Reserved Hundreds place: indicates whether to enable speed-loop integral separation 0: Disable 1: Enable Thousands place: Reserved 0: Reserved 1: Reserved	0x0000	○
P03.36	Speed-loop differential gain	Setting range: 0.00–10.00s	0.00s	○
P03.37–P03.44	Reserved	-	-	-
P03.45	SM max. flux	Setting range: 0.0–200.0%	100.0%	◎

Function code	Name	Description	Default	Modify
	weakening current			
P03.46	Reserved	-	-	-
P03.47	Bus voltage delay compensation	Setting range: 0–60000	0	○
P03.48–P03.61	Reserved	-	-	-

Group P04—V/F control

Function code	Name	Description	Default	Modify
P04.00	V/F curve setting of motor 1	<p>Specifies the V/F curve of motor 1 to meet the needs of different loads. Setting range: 0–5</p> <p>0: Straight-line V/F curve, applicable to constant torque loads 1: Multi-point V/F curve 2: Torque-down V/F curve (power of 1.3) 3: Torque-down V/F curve (power of 1.7) 4: Torque-down V/F curve (power of 2.0)</p> <p>Curves 2 – 4 are applicable to the torque loads such as fans and water pumps. You can adjust according to the characteristics of the loads to achieve best performance. 5: Customized V/F (V/F separation); in this mode, V can be separated from F, and F can be adjusted through the frequency setting channel specified by P00.06 or the voltage setting channel specified by P04.27 to change the characteristics of the curve.</p>	0	◎

Function code	Name	Description	Default	Modify
P04.01	Torque boost of motor 1	Setting range: 0.0%–10.0% (of the rated voltage of motor 1)  Note: When the value is set to 0.0%, the VFD uses automatic torque boost.	0.0%	<input type="radio"/>
P04.02	Torque boost cut-off of motor 1	Setting range: 0.0%–50.0% (of the rated frequency of motor 1)	20.0%	<input type="radio"/>
P04.03	V/F frequency point 1 of motor 1	When P04.00 = 1 (multi-dot V/F curve), you can set the V/F curve through P04.03–P04.08. Setting range: 0.00Hz–P04.05  Note: $V1 < V2 < V3$, $f1 < f2 < f3$ Too high voltage for low frequency will cause motor overheat or damage and cause VFD overcurrent stall or overcurrent protection.	0.00Hz	<input type="radio"/>
P04.04	V/F voltage point 1 of motor 1	Setting range: 0.0%–110.0% (of the rated voltage of motor 1)  Note: Refer to the description for P04.03.	0.0%	<input type="radio"/>
P04.05	V/F frequency point 2 of motor 1	Setting range: P04.03–P04.07  Note: Refer to the description for P04.03.	0.00Hz	<input type="radio"/>
P04.06	V/F voltage point 2 of motor 1	Setting range: 0.0%–110.0% (of the rated voltage of motor 1)  Note: Refer to the description for P04.03.	0.0%	<input type="radio"/>
P04.07	V/F frequency point 3 of motor 1	Setting range: P04.05–P02.02 (Rated frequency of AM 1) or P04.05–P02.16 (Rated frequency of SM 1)  Note: Refer to the description for P04.03.	0.00Hz	<input type="radio"/>
P04.08	V/F voltage point 3 of motor 1	Setting range: 0.0%–110.0% (of the rated voltage of motor 1)  Note: Refer to the description for P04.03.	0.0%	<input type="radio"/>

Function code	Name	Description	Default	Modify
P04.09	V/F slip compensation gain of motor 1	Used to compensate for the motor rotating speed change caused by load change in the space voltage vector mode, and thus improve the rigidity of the mechanical characteristics of the motor. Setting range: 0.0–200.0%	100.0%	<input type="radio"/>
P04.10	Low-frequency oscillation control factor of motor 1	In space voltage vector control mode, the motor, especially the large-power motor, may experience current oscillation at certain frequencies, which may cause unstable motor running, or even VFD overcurrent. You can adjust the two function parameters properly to eliminate such phenomenon. Setting range: 0–100	10	<input type="radio"/>
P04.11	High-frequency oscillation control factor of motor 1		10	<input type="radio"/>
P04.12	Oscillation control threshold of motor 1	Setting range: 0.00Hz–P00.03 (Max. output frequency)	30.00Hz	<input type="radio"/>
P04.13–P04.26	Reserved	-	-	-
P04.27	Voltage setting channel	Setting range: 0–7 0: Keypad (determined by P04.28) 1: AI1 2: AI2 3: AI3 4: HDIA 5: Multi-step speed running (The setting is determined by related parameters in group P10.) 6: PID 7: Modbus communication	0	<input type="radio"/>
P04.28	Voltage set through keypad	The function code is the voltage digital setting when "keypad" is selected as the voltage setting	100.0%	<input type="radio"/>

Function code	Name	Description	Default	Modify
		channel. Setting range: 0.0%–100.0%		
P04.29	Voltage increase time	Voltage increase time means the time needed for the VFD to accelerate from min. output voltage to the max. output frequency. Setting range: 0.0–3600.0s	5.0s	<input type="radio"/>
P04.30	Voltage decrease time	Voltage decrease time means the time needed for the VFD to decelerate from the max. output frequency to min. output voltage. Setting range: 0.0–3600.0s	5.0s	<input type="radio"/>
P04.31	Max. output voltage	Specifies the upper limit of output voltage. Setting range: P04.32–100.0% (of the motor rated voltage)	100.0%	<input checked="" type="radio"/>
P04.32	Min. output voltage	Specifies the lower limit of output voltage. Setting range: 0.0%–P04.31 (of the motor rated voltage)	0.0%	<input checked="" type="radio"/>
P04.33	Weakening coefficient in constant power zone	1.00–1.30	1.00	<input type="radio"/>
P04.34	Pull-in current 1 in SM V/F control	When the SM V/F control mode is enabled, the function code is used to set the reactive current of the motor when the output frequency is lower than the frequency specified by P04.36. Setting range: -100.0%–100.0% (of the motor rated current)	20.0%	<input type="radio"/>
P04.35	Pull-in current 2 in SM V/F control	When the SM V/F control mode is enabled, the function code is used to set the reactive current of the motor when the output frequency is greater than the frequency specified	10.0%	<input type="radio"/>



Function code	Name	Description	Default	Modify
		by P04.36. Setting range: -100.0%–100.0% (of the motor rated current)		
P04.36	Frequency threshold for pull-in current switching in SM V/F control	When the SM VF control mode is enabled, the function code is used to set the frequency threshold for the switching between pull-in current 1 and pull-in current 2. Setting range: 0.0%–200.0% (of the motor rated frequency).	20.0%	○
P04.37	Reactive current closed-loop proportional coefficient in SM V/F control	When the SM VF control mode is enabled, the function code is used to set the proportional coefficient of reactive current closed-loop control. Setting range: 0–3000	50	○
P04.38	Reactive current closed-loop integral time in SM V/F control	When the SM VF control mode is enabled, the function code is used to set the integral coefficient of reactive current closed-loop control. Setting range: 0–3000	30	○
P04.39–P04.51	Reserved	-	-	-

Group P05—Input terminal functions

Function code	Name	Description	Default	Modify
P05.00	HDI input type	Setting range: 0–1 0: HDIA is high-speed pulse input 1: HDIA is digital input	0	◎
P05.01	S1 function selection	Setting range: 0–95 0: No function	1	◎
P05.02	S2 function selection	1: Run forward 2: Run reversely	4	◎
P05.03	S3 function selection	3: Three-wire running control 4: Jog forward	7	◎



Function code	Name	Description	Default	Modify
P05.04	S4 function selection	5: Jog reversely 6: Coast to stop	0	⊙
P05.05	S5 function selection	7: Reset faults 8: Pause running 9: External fault input	0	⊙
P05.06	S6 function selection	10: Increase frequency setting (UP) 11: Decrease frequency setting (DOWN)	0	⊙
P05.07	S7 function selection	12: Clear the frequency increase/decrease setting	0	⊙
P05.08	S8 function selection	13: Switch between A setting and B setting	0	⊙
P05.09	Function of HDIA	14: Switch between combination setting and A setting 15: Switch between combination setting and B setting 16: Multi-step speed terminal 1 17: Multi-step speed terminal 2 18: Multi-step speed terminal 3 19: Multi-step speed terminal 4 20: Pause multi-step speed running 21: ACC/DEC time selection 1 22: ACC/DEC time selection 2 23: Simple PLC stop reset 24: Pause simple PLC 25: Pause PID control 26: Pause wobbling frequency 27: Reset wobbling frequency 28: Counter reset 29: Switch between speed control and torque control 30: Disable ACC/DEC 31: Trigger the counter 32: Reserved 33: Clear the frequency increase/decrease setting temporarily 34: DC braking	0	⊙

Function code	Name	Description	Default	Modify
		35: Reserved 36: Switch the running command channel to keypad 37: Switch the running command channel to terminal 38: Switch the running command channel to communication 39: Pre-exciting command 40: Clear electricity consumption 41: Keep electricity consumption 42: Switch the setting source of braking torque upper limit to keypad 43–55: Reserved 56: Emergency stop 57–60: Reserved 61: Switch PID polarities 62–95: Reserved  Note: Terminals S5–S8 are virtual terminals, of which the enabling is specified by P05.12. After a virtual terminal is enabled, the terminal status can be changed only in communication mode. The communication address is 0x200A.		
P05.10	Input terminal polarity selection	Specifies input terminal polarity. When a bit is 0, the input terminal is positive. When a bit is 1, the input terminal is negative. Setting range: 0x000–0x1FF	0x000	<input type="radio"/>
P05.11	Digital filter time	Specifies the sampling filter time of the S1–S8 and HDIA terminals. In strong interference cases, increase the value to avoid maloperation. Setting range: 0.000–1.000s	0.010s	<input type="radio"/>
P05.12	Virtual	Setting range: 0x00–0x3F (0: disable,	0x00	<input checked="" type="radio"/>

Function code	Name	Description	Default	Modify
	terminal setting	1: enable) Bit 0: S1 virtual terminal Bit 1: S2 virtual terminal Bit 2: S3 virtual terminal Bit 3: S4 virtual terminal Bit 4: S5 virtual terminal Bit 5: S6 virtual terminal Bit 6: S7 virtual terminal Bit 7: S8 virtual terminal Bit 8: HDIA virtual terminal  Note: After a virtual terminal is enabled, the terminal status can be changed only in communication mode. The communication address is 0x200A.		
P05.13	Terminal control mode	Specifies the terminal control mode. Setting range: 0–3 0: Two-wire control mode 1 1: Two-wire control mode 2 2: Three-wire control mode 1 3: Three-wire control mode 2	0	<input checked="" type="radio"/>
P05.14	S1 switch-on delay	Used to specify the delay time corresponding to the electrical level change when a programmable input terminal switches on or switches off. Setting range: 0.000–50.000s  Note: Terminals S5–S8 are virtual terminals, of which the enabling is specified by P05.12. After a virtual terminal is enabled, the terminal status can be changed only in communication mode. The communication address is 0x200A.	0.000s	<input type="radio"/>
P05.15	S1 switch-off delay		0.000s	<input type="radio"/>
P05.16	S2 switch-on delay		0.000s	<input type="radio"/>
P05.17	S2 switch-off delay		0.000s	<input type="radio"/>
P05.18	S3 switch-on delay		0.000s	<input type="radio"/>
P05.19	S3 switch-off delay		0.000s	<input type="radio"/>
P05.20	S4 switch-on delay		0.000s	<input type="radio"/>
P05.21	S4 switch-off delay		0.000s	<input type="radio"/>

Function code	Name	Description	Default	Modify
P05.22	S5 switch-on delay		0.000s	<input type="radio"/>
P05.23	S5 switch-off delay		0.000s	<input type="radio"/>
P05.24	S6 switch-on delay		0.000s	<input type="radio"/>
P05.25	S6 switch-off delay		0.000s	<input type="radio"/>
P05.26	S7 switch-on delay		0.000s	<input type="radio"/>
P05.27	S7 switch-off delay		0.000s	<input type="radio"/>
P05.28	S8 switch-on delay		0.000s	<input type="radio"/>
P05.29	S8 switch-off delay		0.000s	<input type="radio"/>
P05.30	HDIA switch-on delay		0.000s	<input type="radio"/>
P05.31	HDIA switch-off delay		0.000s	<input type="radio"/>
P05.32	A11 lower limit	Setting range: 0.00V–P05.34	0.00V	<input type="radio"/>
P05.33	Corresponding setting of A11 lower limit	Setting range: -300.0%–300.0%	0.0%	<input type="radio"/>
P05.34	A11 upper limit	Setting range: P05.32–10.00V	10.00V	<input type="radio"/>
P05.35	Corresponding setting of A11 upper limit	Setting range: -300.0%–300.0%	100.0%	<input type="radio"/>
P05.36	A11 input filter time	Setting range: 0.000s–10.000s	0.030s	<input type="radio"/>
P05.37	A12 lower limit	Setting range: 0.00V–P05.39	0.00V	<input type="radio"/>
P05.38	Corresponding setting of A12 lower limit	Setting range: -300.0%–300.0%	0.0%	<input type="radio"/>

Function code	Name	Description	Default	Modify
P05.39	AI2 upper limit	Setting range: P05.37–10.00V	10.00V	<input type="radio"/>
P05.40	Corresponding setting of AI2 upper limit	Setting range: -300.0%–300.0%	100.0%	<input type="radio"/>
P05.41	AI2 input filter time	Setting range: 0.000s–10.000s	0.030s	<input type="radio"/>
P05.42	AI3 lower limit	Setting range: 0.00V–P05.44	0.00V	<input type="radio"/>
P05.43	Corresponding setting of AI3 lower limit	Setting range: -300.0%–300.0%	0.0%	<input type="radio"/>
P05.44	AI3 upper limit	Setting range: P05.42–10.00V	10.00V	<input type="radio"/>
P05.45	Corresponding setting of AI3 upper limit	Setting range: -300.0%–300.0%	100.0%	<input type="radio"/>
P05.46	AI3 input filter time	Setting range: 0.000s–10.000s	0.030s	<input type="radio"/>
P05.47	HDIA frequency lower limit	Setting range: 0.000kHz– <u>P05.49</u>	0.000kHz	<input type="radio"/>
P05.48	Corresponding setting of HDIA frequency lower limit	Setting range: -300.0%–300.0%	0.0%	<input type="radio"/>
P05.49	HDIA frequency upper limit	Setting range: P05.47–50.000kHz	50.000 kHz	<input type="radio"/>
P05.50	Corresponding setting of HDIA upper limit frequency	Setting range: -300.0%–300.0%	100.0%	<input type="radio"/>
P05.51	HDIA frequency input filter time	Setting range: 0.000s–10.000s	0.030s	<input type="radio"/>
P05.52	AI1 input	Setting range: 0–1	0	<input checked="" type="radio"/>

Function code	Name	Description	Default	Modify
	signal type	0: Voltage 1: Current  Note: When the switch of AI1 is turned to "V", set the value to 0; otherwise, set the value to 1.		
P05.53	AI3 input signal source selection	Setting range: 0–1 0: Local potentiometer 1: External keypad potentiometer  Note: For details, see the analog potentiometer description in the keypad operation section.	0	⊙

Group P06—Output terminal functions

Function code	Name	Description	Default	Modify
P06.00	Reserved	-	-	-
P06.01	Y1 output selection	Setting range: 0–63 0: Disable	0	○
P06.02	Reserved	1: Running	-	-
P06.03	RO1 output selection	2: Running forward 3: Running reversely	1	○
P06.04	RO2 output selection	4: Jogging 5: VFD in fault 6: Frequency level detection FDT1 7: Frequency level detection FDT2 8: Frequency reached 9: Running in zero speed 10: Frequency upper limit reached 11: Frequency lower limit reached 12: Ready for running 13: Pre-exciting 14: Overload pre-alarm 15: Underload pre-alarm 16: Simple PLC stage completed 17: Simple PLC cycle completed 18: Set counting value reached 19: Designated counting value	5	○

Function code	Name	Description	Default	Modify
		reached 20: External fault is valid 21: Reserved 22: Running time reached 23: MODBUS communication virtual terminal output 24: Reserved 25: Reserved 26: DC bus voltage established 27-28: Reserved 29: STO action 30-36: Reserved 37: Any frequency reached 38-63: Reserved		
P06.05	Output terminal polarity selection	Specifies output terminal polarity. Setting range: 0x00-0x0F BIT0: Y1 Bit1: Reserved Bit 2: RO1 Bit 3: RO2	0x00	<input type="radio"/>
P06.06	Y1 switch-on delay	Specifies the delay time corresponding to the electrical level change when a programmable output terminal switches on or switches off. Setting range: 0.000-50.000s	0.000s	<input type="radio"/>
P06.07	Y1 switch-off delay	Specifies the delay time corresponding to the electrical level change when a programmable output terminal switches on or switches off. Setting range: 0.000-50.000s	0.000s	<input type="radio"/>
P06.08- P06.09	Reserved	-	-	-
P06.10	RO1 switch-on delay	Specifies the delay time corresponding to the electrical level change when a programmable	0.000s	<input type="radio"/>

Function code	Name	Description	Default	Modify
		output terminal switches on or switches off. Setting range: 0.000–50.000s		
P06.11	RO1 switch-off delay	Specifies the delay time corresponding to the electrical level change when a programmable output terminal switches on or switches off. Setting range: 0.000–50.000s	0.000s	<input type="radio"/>
P06.12	RO2 switch-on delay	Specifies the delay time corresponding to the electrical level change when a programmable output terminal switches on or switches off. Setting range: 0.000–50.000s	0.000s	<input type="radio"/>
P06.13	RO2 switch-off delay	Specifies the delay time corresponding to the electrical level change when a programmable output terminal switches on or switches off. Setting range: 0.000–50.000s	0.000s	<input type="radio"/>
P06.14	AO1 output selection	Setting range: 0–63 0: Running frequency (100% corresponds to max. output frequency)	0	<input type="radio"/>
P06.15	Reserved		0	<input type="radio"/>
P06.16	Reserved	1: Set frequency (100% corresponds to max. output frequency) 2: Ramp reference frequency (100% corresponds to max. output frequency) 3: Rotational speed (100% corresponds to the speed corresponding to the max. output frequency) 4: Output current (100% corresponds to twice the VFD rated current)	0	<input type="radio"/>

Function code	Name	Description	Default	Modify
		5: Output current (100% corresponds to twice the motor rated current) 6: Output voltage (100% corresponds to 1.5 times the VFD rated voltage) 7: Output power (100% corresponds to twice the motor rated power) 8: Set torque (100% corresponds to twice the motor rated torque) 9: Output torque (Absolute value, 100% corresponds to twice the motor rated torque) 10: AI1 input (0–10V/0–20mA) 11: AI2 input (0–10V) 12: AI3 input (0–10V) 13: HDIA input (0.00–50.00kHz) 14: Value 1 set through Modbus communication (0–1000) 15: Value 2 set through Modbus communication (0–1000) 16–21: Reserved 22: Torque current (100% corresponds to triple the motor rated current) 23: Exciting current (100% corresponds to triple the motor rated current) 24: Set frequency (bipolar) 25: Ramp reference frequency (bipolar) 26: Rotational speed (bipolar) 27–29: Reserved 30: Rotational speed (100% corresponds to twice the motor rated synchronous speed) 31: Output torque (100% corresponds to twice the motor		

Function code	Name	Description	Default	Modify
		rated torque) 32–63: Reserved		
P06.17	AO1 output lower limit	Setting range: -300.0%– <u>P06.19</u>	0.0%	<input type="radio"/>
P06.18	AO1 output corresponding to lower limit	Setting range: 0.00V–10.00V	0.00V	<input type="radio"/>
P06.19	AO1 output upper limit	Setting range: <u>P06.17</u> –300.0%	100.0%	<input type="radio"/>
P06.20	AO1 output corresponding to upper limit	Setting range: 0.00V–10.00V	10.00V	<input type="radio"/>
P06.21	AO1 output filter time	Setting range: 0.000s–10.000s	0.000s	<input type="radio"/>
P06.22– P06.32	Reserved	-	-	-
P06.33	Detection value for frequency being reached	The "Any frequency reached" signal is output when the ramp reference frequency is greater than the value specified by P06.33 and this situation lasts the time specified by P06.34. Setting range: 0.00Hz–P00.03 (Max. output frequency)	1.00Hz	<input type="radio"/>
P06.34	Frequency reaching detection time	Setting range: 0–3600.0s	0.5s	<input type="radio"/>

Group P07—Human-machine interface

Function code	Name	Description	Default	Modify
P07.00	User password	The user password protection function is not enabled by default (that is, the default value is 0). If it is	0	<input type="radio"/>

Function code	Name	Description	Default	Modify
		<p>set to any non-zero value, the password protection function is enabled. After you exit the function code editing interface, the password takes effect within 1 minute. When you press the PRG/JOG key, "0.0.0.0.0" is displayed. You need to enter the correct user password to enter the function code editing interface.</p> <p>When you set the value to 00000, the user password you have set is cleared, and the user password protection function is disabled. Setting range: 0–65535</p>		
P07.01	Parameter copy	<p>Setting range: 0–4 0: No operation 1: Upload parameters to the keypad 2: Download all parameters (including motor parameters) 3: Download non-motor parameters 4: Download motor parameters Note: The parameter copying function is available only for the external parameter copying keypad, excluding the local LED film keypad and external common keyboard.</p>	0	⊙

Function code	Name	Description	Default	Modify
P07.02	Key function selection	Setting range: 0x00–0x26 Ones place: Function selection of PRO/JOG (pressed long) 0: No function 1: Jog 2: Reserved 3: Switch between forward and reverse rotating 4: Clear the UP/DOWN setting 5: Coast to stop 6: Switch command channels in sequence Tens place: Reserved	0x01	<input checked="" type="radio"/>
P07.03	Sequence of switching running-command channels through PRO/JOG (pressed long)	Specifies the sequence of switching running-command channels by pressing the key when P07.02 = 6. Setting range: 0–3 0: Keypad→Terminal→Communication 1: Keypad←→Terminal 2: Keypad←→Communication 3: Terminal←→Communication	0	<input type="radio"/>
P07.04	Stop function validity of STOP/RST	Specifies the validness range of the stop function. For fault reset, the key is valid in any conditions. Setting range: 0–3 0: Valid for keypad control only 1: Valid both for keypad and terminal control 2: Valid both for keypad and communication control 3: Valid for all control modes	0	<input type="radio"/>
P07.05	Selection 1 of parameters	Setting range: 0x0000–0xFFFF Bit 0: Running frequency (Hz on)	0x03FF	<input type="radio"/>

Function code	Name	Description	Default	Modify
	displayed in running state	Bit 1: Set frequency (Hz blinking) BIT2: Bus voltage (V on) Bit 3: Output voltage (V on) Bit 4: Output current (A on) Bit 5: Running speed (rpm on) Bit 6: Output power (% on) Bit 7: Output torque (% on) Bit 8: PID reference value (% blinking) BIT9: PID feedback value (% on) Bit 10: Input terminal status Bit 11: Output terminal status BIT12: Set torque (% on) BIT13: Pulse count value BIT 4: Motor overload percentage (% on) BIT15: PLC and current step number of multi-step speed		
P07.06	Selection 2 of parameters displayed in running state	Setting range: 0x0000-0Xffff Bit 0: AI1 (V on) Bit 1: AI2 (V on) Bit 2: AI3 (V on) Bit 3: High-speed pulse HDIA frequency Bit 4: Reserved Bit 5: VFD overload percentage (% on) Bit 6: Ramp frequency reference (Hz on) Bit 7: Linear speed Bit 8: Reserved Bit 9: Frequency upper limit Bit 10–Bit 15: Reserved	0x0000	○
P07.07	Selection of parameters displayed in stopped state	Setting range: 0x0000-0xFFFF Bit 0: Set frequency (Hz on, blinking slowly) Bit 1: Bus voltage (V on)	0x00FF	○

Function code	Name	Description	Default	Modify
		Bit 2: Input terminal status Bit 3: Output terminal status Bit 4: PID reference value (% blinking) Bit 5: PID feedback value (% on) Bit 6: Set torque (% on) Bit 7: AI1 value (V on) Bit 8: AI2 value (V on) Bit 9: AI3 value (V on) Bit 10: High-speed pulse HDIA frequency Bit 11: Reserved Bit 12: Count value Bit 13: PLC and current step number of multi-step speed Bit 14: Frequency upper limit Bit 15: Reserved		
P07.08	Frequency display coefficient	Setting range: 0.01–10.00 Display frequency = Running frequency * P07.08	1.00	<input type="radio"/>
P07.09	Rotational speed display coefficient	Setting range: 0.1–999.9% Mechanical rotation speed = $120 \times (\text{Displayed running frequency}) \times P07.09 / (\text{Number of motor pole pairs})$	100.0%	<input type="radio"/>
P07.10	Linear speed display coefficient	Setting range: 0.1–999.9% Linear speed = (Mechanical rotation speed) $\times P07.10$	1.0%	<input type="radio"/>
P07.11	Control board software version	Setting range: 1.00–655.35	Version depended	<input checked="" type="radio"/>
P07.12	Inverter temperature	Setting range: -20.0–120.0°C	0.0°C	<input checked="" type="radio"/>
P07.13	Drive board software version	Setting range: 1.00–655.35	Version depended	<input checked="" type="radio"/>
P07.14	Local	Setting range: 0–65535h	0h	<input checked="" type="radio"/>

Function code	Name	Description	Default	Modify
	accumulative running time			
P07.15	VFD electricity consumption high bit	Displays the electricity consumption of the VFD. VFD electricity consumption = $P07.15 \times 1000 + P07.16$ Setting range: 0–65535kWh (*1000)	0kWh	●
P07.16	VFD electricity consumption low bit	Displays the electricity consumption of the VFD. VFD electricity consumption = $P07.15 \times 1000 + P07.16$ Setting range: 0.0–999.9kWh	0.0kWh	●
P07.17	VFD model	Setting range: 0–1	0	●
P07.18	VFD rated power	Setting range: 0.4–3000.0kW	0.4kW	●
P07.19	VFD rated voltage	Setting range: 50–520V	380V	●
P07.20	VFD rated current	Setting range: 0.01–600.00A	0.01A	●
P07.21	Factory bar code 1	Setting range: 0x0000–0xFFFF	0xFFFF	●
P07.22	Factory bar code 2	Setting range: 0x0000–0xFFFF	0xFFFF	●
P07.23	Factory bar code 3	Setting range: 0x0000–0xFFFF	0xFFFF	●
P07.24	Factory bar code 4	Setting range: 0x0000–0xFFFF	0xFFFF	●
P07.25	Factory bar code 5	Setting range: 0x0000–0xFFFF	0xFFFF	●
P07.26	Factory bar code 6	Setting range: 0x0000–0xFFFF	0xFFFF	●
P07.27	Present-fault type	Setting range: 0–94 0: No fault	0	●
P07.28	Last-fault type	1–3: Reserved	0	●
P07.29	2nd-last fault type	4: Overcurrent during ACC (E4) 5: Overcurrent during DEC (E5)	0	●

Function code	Name	Description	Default	Modify
P07.30	3rd-last fault type	6: Overcurrent during constant speed running (E6)	0	●
P07.31	4th-last fault type	7: Overvoltage during ACC (E7) 8: Overvoltage during DEC (E8) 9: Overvoltage during constant speed running (E9)	0	●
P07.32	5th-last fault type	10: Bus undervoltage fault (E10) 11: Motor overload (E11) 12: VFD overload (E12) 13: Phase loss on input side (E13) 14: Phase loss on output side (E14) 15: Reserved 16: Inverter module overheat (E16) 17: External fault (E17) 18: Modbus communication fault (E18) 19: Current detection fault (E19) 20: Motor autotuning fault (E20) 21: EEPROM operation error (E21) 22: PID feedback offline fault (E22) 23: Braking unit fault (E23) 24: Running time reached (E24) 25: Electronic overload (E25) 26: Reserved 27: Parameter upload error (E27) 28: Parameter download error (E28) 29-31: Reserved 32: To-ground short-circuit fault 1 (E32) 33: To-ground short-circuit fault 2 (E33) 34: Speed deviation fault (E34) 35: Mal-adjustment fault (E35) 36: Underload fault (E36) 37-39: Reserved 40: Safe torque off (E40) 41: Exception to safety circuit of channel 1 (E41) 42: Exception to safety circuit of channel 2 (E42) 43: Exception to both channels 1 and 2 (E43)	0	●

Function code	Name	Description	Default	Modify
		44: AI1 disconnection fault (E44) 45: AI2 disconnection fault (E45) 46: AI3 disconnection fault (E46) 44-91: Reserved 92: AI1 disconnection fault (E92) 93: AI2 disconnection fault (E93) 94: AI3 disconnection fault (E94)		
P07.33	Running frequency at present fault	Setting range: 0.00Hz-P00.03	0.00Hz	●
P07.34	Ramp reference frequency at present fault	Setting range: 0.00Hz-P00.03	0.00Hz	●
P07.35	Output voltage at present fault	Setting range: 0-1200V	0V	●
P07.36	Output current at present fault	Setting range: 0.00-630.00A	0.00A	●
P07.37	Bus voltage at present fault	Setting range: 0.0-2000.0V	0.0V	●
P07.38	Max. temperature at present fault	Setting range: -20.0-120.0°C	0.0°C	●
P07.39	Input terminal status at present fault	Setting range: 0x0000-0xFFFF	0x0000	●
P07.40	Output terminal status at present fault	Setting range: 0x0000-0xFFFF	0x0000	●
P07.41	Running frequency at last fault	Setting range: 0.00Hz-P00.03	0.00Hz	●
P07.42	Ramp	Setting range: 0.00Hz-P00.03	0.00Hz	●

Function code	Name	Description	Default	Modify
	reference frequency at last fault			
P07.43	Output voltage at last fault	Setting range: 0–1200V	0V	●
P07.44	Output current at last fault	Setting range: 0.00–630.00A	0.00A	●
P07.45	Bus voltage at last fault	Setting range: 0.0–2000.0V	0.0V	●
P07.46	Temperature at last fault	Setting range: -20.0–120.0°C	0.0°C	●
P07.47	Input terminal status at last fault	Setting range: 0x0000–0xFFFF	0x0000	●
P07.48	Output terminal status at last fault	Setting range: 0x0000–0xFFFF	0x0000	●
P07.49	Running frequency at 2nd-last fault	Setting range: 0.00Hz–P00.03	0.00Hz	●
P07.50	Ramp reference frequency at 2nd-last fault	Setting range: 0.00Hz–P00.03	0.00Hz	●
P07.51	Output voltage at 2nd-last fault	Setting range: 0–1200V	0V	●
P07.52	Output current at 2nd-last fault	Setting range: 0.00–630.00A	0.00A	●
P07.53	Bus voltage at 2nd-last fault	Setting range: 0.0–2000.0V	0.0V	●
P07.54	Temperature at 2nd-last	Setting range: -20.0–120.0°C	0.0°C	●

Function code	Name	Description	Default	Modify
	fault			
P07.55	Input terminal status at 2nd-last fault	Setting range: 0x0000-0xFFFF	0x0000	●
P07.56	Output terminal status at 2nd-last fault	Setting range: 0x0000-0xFFFF	0x0000	●

Group P08—Enhanced functions

Function code	Name	Description	Default	Modify
P08.00	ACC time 2	Setting range: 0.0–3600.0s	Model depended	<input type="radio"/>
P08.01	DEC time 2	Setting range: 0.0–3600.0s	Model depended	<input type="radio"/>
P08.02	ACC time 3	Setting range: 0.0–3600.0s	Model depended	<input type="radio"/>
P08.03	DEC time 3	Setting range: 0.0–3600.0s	Model depended	<input type="radio"/>
P08.04	ACC time 4	Setting range: 0.0–3600.0s	Model depended	<input type="radio"/>
P08.05	DEC time 4	Setting range: 0.0–3600.0s	Model depended	<input type="radio"/>
P08.06	Running frequency of jog	Specifies the reference frequency during jogging. Setting range: 0.00Hz–P00.03 (Max. output frequency)	5.00Hz	<input type="radio"/>
P08.07	ACC time for jogging	Specifies the time needed for the VFD to accelerate from 0Hz to the max. output frequency (P00.03). Setting range: 0.0–3600.0s	Model depended	<input type="radio"/>
P08.08	DEC time for jogging	Specifies the time needed for the VFD to decelerate from the max. output frequency (P00.03) to 0Hz. Setting range: 0.0–3600.0s	Model depended	<input type="radio"/>

Function code	Name	Description	Default	Modify
P08.09	Jump frequency 1	The VFD can avoid mechanical resonance points by setting jump frequencies. When the set frequency is within the range of jump frequency, the VFD runs at the boundary of jump frequency. The VFD supports the setting of three jump frequencies. If the jump frequency points are set to 0, this function is invalid. Setting range: 0.00Hz–P00.03 (Max. output frequency)	0.00Hz	<input type="radio"/>
P08.10	Jump frequency amplitude 1	The VFD can avoid mechanical resonance points by setting jump frequencies. When the set frequency is within the range of jump frequency, the VFD runs at the boundary of jump frequency. The VFD supports the setting of three jump frequencies. If the jump frequency points are set to 0, this function is invalid. Setting range: 0.00Hz–P00.03 (Max. output frequency)	0.00Hz	<input type="radio"/>
P08.11	Jump frequency 2	The VFD can avoid mechanical resonance points by setting jump frequencies. When the set frequency is within the range of jump frequency, the VFD runs at the boundary of jump frequency. The VFD supports the setting of three jump frequencies. If the jump frequency points are set to 0, this function is invalid. Setting range: 0.00Hz–P00.03 (Max. output frequency)	0.00Hz	<input type="radio"/>
P08.12	Jump	The VFD can avoid mechanical	0.00Hz	<input type="radio"/>

Function code	Name	Description	Default	Modify
	frequency amplitude 2	resonance points by setting jump frequencies. When the set frequency is within the range of jump frequency, the VFD runs at the boundary of jump frequency. The VFD supports the setting of three jump frequencies. If the jump frequency points are set to 0, this function is invalid. Setting range: 0.00Hz–P00.03 (Max. output frequency)		
P08.13	Jump frequency 3	The VFD can avoid mechanical resonance points by setting jump frequencies. When the set frequency is within the range of jump frequency, the VFD runs at the boundary of jump frequency. The VFD supports the setting of three jump frequencies. If the jump frequency points are set to 0, this function is invalid. Setting range: 0.00Hz–P00.03 (Max. output frequency)	0.00Hz	<input type="radio"/>
P08.14	Jump frequency amplitude 3	The VFD can avoid mechanical resonance points by setting jump frequencies. When the set frequency is within the range of jump frequency, the VFD runs at the boundary of jump frequency. The VFD supports the setting of three jump frequencies. If the jump frequency points are set to 0, this function is invalid. Setting range: 0.00Hz–P00.03 (Max. output frequency)	0.00Hz	<input type="radio"/>
P08.15	Amplitude of wobbling	Setting range: 0.0–100.0% (of the set frequency)	0.0%	<input type="radio"/>

Function code	Name	Description	Default	Modify
	frequency			
P08.16	Amplitude of sudden jump frequency	Setting range: 0.0–50.0% (of the amplitude of wobbling frequency)	0.0%	<input type="radio"/>
P08.17	Rise time of wobbling frequency	Setting range: 0.1–3600.0s	5.0s	<input type="radio"/>
P08.18	Fall time of wobbling frequency	Setting range: 0.1–3600.0s	5.0s	<input type="radio"/>
P08.19	Switching frequency of ACC/DEC time	Setting range: 0.00–P00.03 (max. output frequency) 0.00Hz: No switchover If the running frequency is greater than P08.19, switch to ACC/DEC time 2.	0.00Hz	<input type="radio"/>
P08.20	Frequency threshold of the start of droop control	Setting range: 0.00–50.00Hz	2.00Hz	<input type="radio"/>
P08.21	Reference frequency of ACC/DEC time	Setting range: 0–2 0: Max. output frequency 1: Set frequency 2: 100Hz  Note: Valid for straight ACC/DEC only.	0	<input checked="" type="radio"/>
P08.22	Output torque calculation method	Setting range: 0–1 0: Based on torque current 1: Based on output power	0	<input type="radio"/>
P08.23	Number of decimal points of frequency	Setting range: 0–1 0: Two 1: One	0	<input type="radio"/>
P08.24	Number of decimal points of	Setting range: 0–3 0: No decimal point 1: One	0	<input type="radio"/>



Function code	Name	Description	Default	Modify
	linear speed	2: Two 3: Three		
P08.25	Set counting value	Setting range: <u>P08.26</u> –65535	0	○
P08.26	Designated counting value	Setting range: 0– <u>P08.25</u>	0	○
P08.27	Set running time	Setting range: 0–65535min	0min	○
P08.28	Auto fault reset count	Specifies the number of automatic fault reset times when the VFD uses automatic fault reset. When the number of continuous reset times exceeds the value, the VFD reports a fault and stops. After VFD starts, if no fault occurred within 600s after the VFD starts, the number of automatic fault reset times is cleared. Setting range: 0–10	0	○
P08.29	Auto fault reset interval	Specifies the time interval from when a fault occurred to when automatic fault reset takes effect. Setting range: 0.1–3600.0s	1.0s	○
P08.30	Frequency decrease ratio in droop control	Specifies the variation rate of the VFD output frequency based on the load. It is mainly used in balancing the power when multiple motors drive the same load. Setting range: 0.00–50.00Hz	0.00Hz	○
P08.31	Reserved	-	-	-
P08.32	FDT1 electrical level detection value	Used to view the FDT1 electrical level detection value. When the output frequency exceeds the corresponding frequency of FDT electrical level, the multifunction digital output terminal continuously	50.00Hz	○

Function code	Name	Description	Default	Modify
		outputs the signal of "Frequency level detection FDT". The signal is invalid only when the output frequency decreases to a value lower than the frequency corresponding to (FDT electrical level—FDT lagging detection value). Setting range: 0.00Hz–P00.03 (Max. output frequency)		
P08.33	FDT1 lagging detection value	Used to view the FDT1 lagging detection value. When the output frequency exceeds the corresponding frequency of FDT electrical level, the multifunction digital output terminal continuously outputs the signal of "Frequency level detection FDT". The signal is invalid only when the output frequency decreases to a value lower than the frequency corresponding to (FDT electrical level—FDT lagging detection value). Setting range: 0.0–100.0% (relative to FDT1 electrical level)	5.0%	<input type="radio"/>
P08.34	FDT2 electrical level detection value	Used to view the FDT2 electrical level detection value. When the output frequency exceeds the corresponding frequency of FDT electrical level, the multifunction digital output terminal continuously outputs the signal of "Frequency level detection FDT". The signal is invalid only when the output frequency decreases to a value lower than the frequency corresponding to (FDT electrical level—FDT lagging detection value).	50.00Hz	<input type="radio"/>

Function code	Name	Description	Default	Modify
		Setting range: 0.00Hz–P00.03 (Max. output frequency)		
P08.35	FDT2 lagging detection value	Used to view the FDT2 lagging detection value. When the output frequency exceeds the corresponding frequency of FDT electrical level, the multifunction digital output terminal continuously outputs the signal of "Frequency level detection FDT". The signal is invalid only when the output frequency decreases to a value lower than the frequency corresponding to (FDT electrical level—FDT lagging detection value). Setting range: 0.0–100.0% (relative to FDT2 electrical level)	5.0%	○
P08.36	Detection value for frequency being reached	When the output frequency is within the detection range, the multifunction digital output terminal outputs the signal of "Frequency reached". Setting range: 0.00Hz–P00.03 (Max. output frequency)	0.00Hz	○
P08.37	Enabling dynamic braking	Setting range: 0–1 0: Disable 1: Enable	0	○
P08.38	Dynamic braking threshold voltage	Specifies the starting bus voltage of dynamic braking. Adjust this value properly to achieve effective braking for the load. The default value varies depending on the voltage class. Setting range: 200.0–2000.0V	For 220V: 380.0V For 380V: 700.0V For 660V: 1120.0V	○
P08.39	Cooling-fan running mode	Setting range: 0–2 0: Normal mode	0	○

Function code	Name	Description	Default	Modify
		1: Permanent running after power-on 2: Run mode 2		
P08.40	PWM selection	Setting range: 0x0000–0x221 Ones place: PWM mode selection 0: PWM mode 1, 3PH modulation 1: PWM mode 2, 3PH modulation and 2PH modulation Tens place: PWM low-speed carrier frequency limit 0: Low-speed carrier frequency limit mode 1 1: Low-speed carrier frequency limit mode 2 2: No limit on low-speed carrier frequency Hundreds place: Deadzone compensation method 0: Compensation method 1 1: Compensation method 2	0x100	⊙
P08.41	Overmodulation selection	Setting range: 0x0000–0x1111 Ones place: Overmodulation enabling 0: Disable 1: Enable Tens place: Reserved Hundreds place: Carrier frequency limit 0: Yes 1: No Thousands place: Reserved	0x1001	⊙
P08.42– P08.43	Reserved	-	-	-
P08.44	UP/DOWN terminal control setting	Setting range: 0x000–0x221 Ones place: Frequency setting selection 0: The setting made through UP/DOWN is valid.	0x000	○

Function code	Name	Description	Default	Modify
		<p>1: The setting made through UP/DOWN is invalid.</p> <p>Tens place: Frequency control selection</p> <p>0: Valid only when P00.06=0 or P00.07=0</p> <p>1: Valid for all frequency setting methods</p> <p>2: Invalid for multi-step speed running when multi-step speed running has the priority</p> <p>Hundreds place: Action selection for stop</p> <p>0: Setting is valid.</p> <p>1: Valid during running, cleared after stop</p> <p>2: Valid during running, cleared after a stop command is received</p>		
P08.45	Frequency increment integral rate of the UP terminal	Setting range: 0.01–50.00Hz/s	0.50Hz/s	<input type="radio"/>
P08.46	Frequency increment integral rate of the DOWN terminal	Setting range: 0.01–50.00Hz/s	0.50Hz/s	<input type="radio"/>
P08.47	Action selection at power-off during frequency setting	<p>Setting range: 0x000–0x111</p> <p>Ones place: Reserved</p> <p>Action selection at power-off during frequency adjusting through Modbus communication</p> <p>0: Save the setting at power-off.</p> <p>1: Clear the setting at power-off.</p> <p>Hundreds place: Reserved</p>	0x000	<input type="radio"/>
P08.48	Initial electricity consumption	<p>Specifies the initial electricity consumption.</p> <p>Initial electricity consumption =</p>	0kWh	<input type="radio"/>

Function code	Name	Description	Default	Modify
	high bit	P08.48 × 1000 + P08.49 Setting range: 0–59999kWh (k)		
P08.49	Initial electricity consumption low bit	Specifies the initial electricity consumption. Initial electricity consumption = P08.48 × 1000 + P08.49 Setting range: 0.0–999.9kWh	0.0kWh	○
P08.50	Magnetic flux braking	Used to enable the magnetic flux braking. Magnetic flux braking can be used for motor flux, as well as for motor rotation speed change. The current of the stator other than the rotor increases during magnetic flux braking. Therefore, the cooling is better. 0: Disable 100–150: A larger coefficient indicates stronger braking. Setting range: 0, 100–150	0	○
P08.51	VFD input power factor	Used to adjust the current display value on the AC input side. Setting range: 0.00–1.00	0.56	○
P08.52	STO lock selection	Setting range: 0–1 0: Lock upon STO (E40) alarm 1: No lock on STO (E40) alarm  Note: "Lock on STO (E40) alarm" indicates the STO alarm must be reset after the VFD recovers from the STO (E40) fault. "No lock on STO (E40) alarm" indicates that the STO alarm disappears automatically after the VFD recovers from the STO fault.	0	○
P08.53	Upper limit frequency bias value in torque control	Setting range: 0.00Hz–P00.03 (Max. output frequency)  Note: Valid for torque control only.	0.00Hz	○

Function code	Name	Description	Default	Modify
P08.54	Upper limit frequency ACC/DEC selection in torque control	Setting range: 0–4 0: No limit on acceleration or deceleration 1: ACC/DEC time 1 2: ACC/DEC time 2 3: ACC/DEC time 3 4: ACC/DEC time 4	0	<input type="radio"/>
P08.55	Enabling auto carrier frequency reduction	Setting range: 0–1 0: Disable 1: Enable  Note: Automatic carrier frequency reduction indicates that the VFD automatically reduces the carrier frequency when detecting the heat sink temperature exceeds the rated temperature. When the temperature decreases to a specified value, the carrier frequency restores to the setting. This function can reduce the VFD overheat alarm reporting chances.	0	<input type="radio"/>
P08.56	Min. carrier frequency	Setting range: 0.0–15.0kHz	4.0kHz	<input type="radio"/>
P08.57	Temperature point of auto carrier frequency reduction	Setting range: 40.0–85.0°C	70.0°C	<input type="radio"/>
P08.58	Interval of carrier frequency reduction	Setting range: 0–30s	10s	<input type="radio"/>
P08.59	A11 disconnection detection threshold	Setting range: 0–100% (relative to 10V)	0%	<input type="radio"/>
P08.60	A12	Setting range: 0–100% (relative to	0%	<input type="radio"/>

Function code	Name	Description	Default	Modify
	disconnection detection threshold	10V)		
P08.61	AI3 disconnection detection threshold	Setting range: 0–100% (relative to 10V)	0%	<input type="radio"/>
P08.62	Output current filter time	Setting range: 0.000–10.000s	0.000s	<input type="radio"/>
P08.63	Output torque filter times	Setting range: 0–8	8	<input type="radio"/>
P08.64	STO enabling	Setting range: 0–1 0: Disable 1: Enable	0	<input type="radio"/>
P08.65	STO power supply detection	Setting range: 0–1 0: Normal 1: Abnormal	0	<input checked="" type="radio"/>
P08.66–P08.68	Reserved	-	-	-

Group P09—PID control

Function code	Name	Description	Default	Modify
P09.00	PID reference source selection	Specifies the target given channel during the PID process. Setting range: 0–6 0: Keypad digital (P09.01) 1: AI1 2: AI2 3: AI3 4: High-speed pulse HDIA 5: Multi-step running 6: Modbus communication  Note: The set target of process PID is a relative value, for which 100% equals 100% of the feedback	0	<input type="radio"/>

Function code	Name	Description	Default	Modify
		signal of the controlled system. The system always calculates a related value (0–100.0%).		
P09.01	PID reference preset through keypad	Setting range: -100.0%–100.0%	0.0%	<input type="radio"/>
P09.02	PID feedback source selection	Specifies the PID feedback channel. Setting range: 0–4 0: AI1 1: AI2 2: AI3 3: High-speed pulse HDIA 4: Modbus communication  Note: The reference channel and feedback channel cannot be duplicated. Otherwise, effective PID control cannot be achieved.	0	<input type="radio"/>
P09.03	PID output characteristics selection	Setting range: 0–1 0: PID output is positive. When the feedback signal is greater than the PID reference value, the output frequency of the VFD will decrease to balance the PID. Example: PID control on strain during unwinding. 1: PID output is negative. When the feedback signal is greater than the PID reference value, the output frequency of the VFD will increase to balance the PID. Example: PID control on strain during unwinding.	0	<input type="radio"/>
P09.04	Proportional gain (Kp)	Specifies the proportional gain P of PID input. Setting range: 0.00–100.00	1.80	<input type="radio"/>
P09.05	Integral time (Ti)	Determines the speed of the integral adjustment on the deviation of PID feedback and	0.90s	<input type="radio"/>

Function code	Name	Description	Default	Modify
		reference from the PID regulator. Setting range: 0.00–10.00s		
P09.06	Differential time (Td)	Determines the strength of the change ratio adjustment on the deviation of PID feedback and reference from the PID regulator. Setting range: 0.00–10.00s	0.00s	<input type="radio"/>
P09.07	Sampling cycle (T)	Specifies the sampling cycle of feedback. The regulator calculates in each sampling cycle. A longer sampling cycle indicates slower response. Setting range: 0.001–1.000s	0.001s	<input type="radio"/>
P09.08	PID control deviation limit	Specifies the max. deviation allowed by the output of PID system relative to the closed loop reference, which can adjust the accuracy and stability of the PID system. Setting range: 0.0–100.0%	0.0%	<input type="radio"/>
P09.09	PID output upper limit	Specifies the upper limit of PID regulator output values. 100.0% corresponds to the max. output frequency (P00.03) or max. voltage (P04.31). Setting range: P09.10–100.0%	100.0%	<input type="radio"/>
P09.10	PID output lower limit	Specifies the lower limit of PID regulator output values. 100.0% corresponds to the max. output frequency (P00.03) or max. voltage (P04.31). Setting range: -100.0%–P09.09	0.0%	<input type="radio"/>
P09.11	Feedback offline detection value	Specifies the PID feedback offline detection value. Setting range: 0.0–100.0%	0.0%	<input type="radio"/>
P09.12	Feedback	Setting range: 0.0–3600.0s	1.0s	<input type="radio"/>

Function code	Name	Description	Default	Modify
	offline detection time			
P09.13	PID control selection	Setting range: 0x0000–0x1111 Ones place: 0: Continue integral control after the frequency reaches upper/lower limit 1: Stop integral control after the frequency reaches upper/lower limit Tens place: 0: Same as the main reference direction 1: Contrary to the main reference direction Hundreds place: 0: Limit as per the max. frequency 1: Limit as per A frequency Thousands place: 0: A+B frequency. ACC/DEC of main reference A frequency source buffering is invalid. 1: A+B frequency. ACC/DEC of main reference A frequency source buffering is valid. The ACC/DEC is determined by P08.04 (ACC time 4).	0x0001	<input type="radio"/>
P09.14	Low frequency proportional gain (Kp)	Setting range: 0.00–100.00 Low-frequency switching point: 5.00Hz High-frequency switching point: 10.00Hz (P09.04 corresponds to high-frequency parameter), and the middle is the linear interpolation between these two points.	1.00	<input type="radio"/>
P09.15	ACC/DEC time of PID command	Setting range: 0.0–1000.0s	0.0s	<input type="radio"/>

Function code	Name	Description	Default	Modify
P09.16	PID output filter time	Setting range: 0.000–10.000s	0.000s	<input type="radio"/>
P09.17	Reserved	-	-	-
P09.18	Low frequency integral time (Ti)	Setting range: 0.00–10.00s	0.90s	<input type="radio"/>
P09.19	Low frequency differential time (Td)	Setting range: 0.00–10.00s	0.00s	<input type="radio"/>
P09.20	Low frequency point for PID parameter switching	Setting range: 0.00–P09.21	5.00Hz	<input type="radio"/>
P09.21	High frequency point for PID parameter switching	Setting range: P09.20–P00.03	10.00Hz	<input type="radio"/>
P09.22–P09.26	Reserved	-	-	-

Group P10—Simple PLC and multi-step speed control

Function code	Name	Description	Default	Modify
P10.00	Simple PLC mode	Setting range: 0–2 0: Stop after running once. The VFD stops automatically after running for one cycle, and it can be started only after receiving the running command. 1: Keep running in the final value after running for one cycle. The VFD keeps the running frequency and direction of the last section after a	0	<input type="radio"/>

Function code	Name	Description	Default	Modify
		single cycle. 2: Cyclic running. The VFD enters the next cycle after completing one cycle until receiving the stop command.		
P10.01	Simple PLC memory selection	Setting range: 0-1 0: Do not memorize at power outage 1: Memorize at power outage. The PLC memories its running stage and running frequency before power-off.	0	<input type="radio"/>
P10.02	Multi-step speed 0	Setting range: -300.0-300.0% The setting 100.0% corresponds to the max. output frequency (P00.03).	0.0%	<input type="radio"/>
P10.03	Running time of step 0	Setting range: 0.0-6553.5s (min) The time unit is specified by P10.37.	0.0s(min)	<input type="radio"/>
P10.04	Multi-step speed 1	Setting range: -300.0-300.0% The setting 100.0% corresponds to the max. output frequency (P00.03).	0.0%	<input type="radio"/>
P10.05	Running time of step 1	Setting range: 0.0-6553.5s (min) The time unit is specified by P10.37.	0.0s(min)	<input type="radio"/>
P10.06	Multi-step speed 2	Setting range: -300.0-300.0% The setting 100.0% corresponds to the max. output frequency (P00.03).	0.0%	<input type="radio"/>
P10.07	Running time of step 2	Setting range: 0.0-6553.5s (min) The time unit is specified by P10.37.	0.0s(min)	<input type="radio"/>
P10.08	Multi-step speed 3	Setting range: -300.0-300.0% The setting 100.0% corresponds to the max. output frequency (P00.03).	0.0%	<input type="radio"/>
P10.09	Running time of step 3	Setting range: 0.0-6553.5s (min) The time unit is specified by P10.37.	0.0s(min)	<input type="radio"/>
P10.10	Multi-step speed 4	Setting range: -300.0-300.0% The setting 100.0% corresponds to the max. output frequency (P00.03).	0.0%	<input type="radio"/>
P10.11	Running time	Setting range: 0.0-6553.5s (min)	0.0s(min)	<input type="radio"/>

Function code	Name	Description	Default	Modify
	of step 4	The time unit is specified by P10.37.		
P10.12	Multi-step speed 5	Setting range: -300.0~300.0% The setting 100.0% corresponds to the max. output frequency (P00.03).	0.0%	○
P10.13	Running time of step 5	Setting range: 0.0~6553.5s (min) The time unit is specified by P10.37.	0.0s(min)	○
P10.14	Multi-step speed 6	Setting range: -300.0~300.0% The setting 100.0% corresponds to the max. output frequency (P00.03).	0.0%	○
P10.15	Running time of step 6	Setting range: 0.0~6553.5s (min) The time unit is specified by P10.37.	0.0s(min)	○
P10.16	Multi-step speed 7	Setting range: -300.0~300.0% The setting 100.0% corresponds to the max. output frequency (P00.03).	0.0%	○
P10.17	Running time of step 7	Setting range: 0.0~6553.5s (min) The time unit is specified by P10.37.	0.0s(min)	○
P10.18	Multi-step speed 8	Setting range: -300.0~300.0% The setting 100.0% corresponds to the max. output frequency (P00.03).	0.0%	○
P10.19	Running time of step 8	Setting range: 0.0~6553.5s (min) The time unit is specified by P10.37.	0.0s(min)	○
P10.20	Multi-step speed 9	Setting range: -300.0~300.0% The setting 100.0% corresponds to the max. output frequency (P00.03).	0.0%	○
P10.21	Running time of step 9	Setting range: 0.0~6553.5s (min) The time unit is specified by P10.37.	0.0s(min)	○
P10.22	Multi-step speed 10	Setting range: -300.0~300.0% The setting 100.0% corresponds to the max. output frequency (P00.03).	0.0%	○
P10.23	Running time of step 10	Setting range: 0.0~6553.5s (min) The time unit is specified by P10.37.	0.0s(min)	○
P10.24	Multi-step speed 11	Setting range: -300.0~300.0% The setting 100.0% corresponds to the max. output frequency (P00.03).	0.0%	○
P10.25	Running time of step 11	Setting range: 0.0~6553.5s (min) The time unit is specified by P10.37.	0.0s(min)	○

Function code	Name	Description	Default	Modify
P10.26	Multi-step speed 12	Setting range: -300.0~300.0% The setting 100.0% corresponds to the max. output frequency (P00.03).	0.0%	<input type="radio"/>
P10.27	Running time of step 12	Setting range: 0.0~6553.5s (min) The time unit is specified by P10.37.	0.0s(min)	<input type="radio"/>
P10.28	Multi-step speed 13	Setting range: -300.0~300.0% The setting 100.0% corresponds to the max. output frequency (P00.03).	0.0%	<input type="radio"/>
P10.29	Running time of step 13	Setting range: 0.0~6553.5s (min) The time unit is specified by P10.37.	0.0s(min)	<input type="radio"/>
P10.30	Multi-step speed 14	Setting range: -300.0~300.0% The setting 100.0% corresponds to the max. output frequency (P00.03).	0.0%	<input type="radio"/>
P10.31	Running time of step 14	Setting range: 0.0~6553.5s (min) The time unit is specified by P10.37.	0.0s(min)	<input type="radio"/>
P10.32	Multi-step speed 15	Setting range: -300.0~300.0% The setting 100.0% corresponds to the max. output frequency (P00.03).	0.0%	<input type="radio"/>
P10.33	Running time of step 15	Setting range: 0.0~6553.5s (min) The time unit is specified by P10.37.	0.0s(min)	<input type="radio"/>
P10.34	ACC/DEC time of steps 0~7 of simple PLC	Setting range: 0x0000~0xFFFF	0x0000	<input type="radio"/>
P10.35	ACC/DEC time of steps 8~15 of simple PLC	Setting range: 0x0000~0xFFFF	0x0000	<input type="radio"/>
P10.36	PLC restart mode	Setting range: 0~1 0: Restart from the first step, namely if the VFD stops during running (caused by stop command, fault or power down), it will run from the first step after restart. 1: Continue running from the step frequency when interruption occurred, namely if the VFD stops during running (caused by stop	0	<input checked="" type="radio"/>

Function code	Name	Description	Default	Modify
		command or fault), it will record the running time of current step, and enters this step automatically after restart, then continue running at the frequency defined by this step in the remaining time.		
P10.37	Multi-step time unit	Setting range: 0–1 0: second; the running time of each step is counted in seconds 1: minute; the running time of each step is counted in minutes	0	<input checked="" type="radio"/>

Group P11—Protection functions

Function code	Name	Description	Default	Modify
P11.00	Phase loss protection	Setting range: 0x000–0x011 Ones place: 0: Disable software input phase loss protection. 1: Enable software input phase loss protection. Tens place: 0: Disable output phase loss protection. 1: Enable output phase loss protection. Hundreds place: Reserved	For 1PH models: 0x010 For 3PH models: 0x011	<input type="radio"/>
P11.01	Frequency drop at transient power-off	Setting range: 0–1 0: Disable 1: Enable	0	<input type="radio"/>
P11.02	Enabling energy-consumption braking for stop	Setting range: 0–1 0: Disable 1: Enable	0	<input checked="" type="radio"/>
P11.03	Overvoltage	Setting range: 0–1	1	<input type="radio"/>

Function code	Name	Description	Default	Modify
	stalling protection	0: Disable 1: Enable		
P11.04	Overvoltage stalling protection	120–150% (standard bus voltage) (380V)	136%	○
	stalling protection voltage	120–150% (standard bus voltage) (220V)	120%	
P11.05	Current limit mode	During accelerated running, as the load is too large, the actual acceleration rate of motor is lower than that of output frequency. To prevent the VFD trip due to overcurrent during acceleration, take the current limit measures. Setting range: 0x00–0x11 Ones place: Current limit action selection 0: Invalid 1: Always valid Tens place: Hardware current limit overload alarm 0: Valid 1: Invalid	0x01	⊙
P11.06	Automatic current limit threshold	Setting range: 50.0–200.0% (of the rated VFD output current)	160.0%	⊙
P11.07	Frequency drop rate during current limit	Setting range: 0.00–50.00Hz/s	10.00 Hz/s	⊙

Function code	Name	Description	Default	Modify
P11.08	VFD/motor OL/UL pre-alarm selection	<p>Setting range: 0x0000–0x1132</p> <p>Ones place:</p> <p>0: Motor OL/UL pre-alarm, relative to the motor rated current.</p> <p>1: VFD OL/UL pre-alarm, relative to VFD rated output current.</p> <p>2: Motor output torque OL/UL pre-alarm, relative to motor rated torque.</p> <p>Tens place:</p> <p>0: The VFD continues to work for an OL/UL alarm</p> <p>1: The VFD continues to work for a UL alarm but stops running for an OL fault</p> <p>2: The VFD continues to work for an OL alarm but stops running for a UL fault</p> <p>3: The VFD stops running for an OL/UL alarm</p> <p>Hundreds place:</p> <p>0: Detect all the time.</p> <p>1: Detect during constant speed running</p> <p>Thousands place: VFD overload current reference selection</p> <p>0: Related to current calibration coefficient</p> <p>1: Unrelated to current calibration coefficient</p>	0x0000	○
P11.09	Underload pre-alarm detection threshold	If the VFD or motor output current is larger than the overload pre-alarm detection level (P11.09), and the duration exceeds the overload	150%	○

Function code	Name	Description	Default	Modify
		pre-alarm detection time (P11.10), overload pre-alarm signal will be outputted. Setting range: P11.11–200% (relative value determined by the ones place of P11.08)		
P11.10	Overload pre-alarm detection time	Setting range: 0.1–3600.0s	1.0s	○
P11.11	Underload pre-alarm detection threshold	Underload pre-alarm signal will be outputted if the output current of the VFD or motor is lower than underload pre-alarm detection level (P11.11), and the duration exceeds underload pre-alarm detection time (P11.12). Setting range: 0 –P11.09 (relative value determined by the ones place of P11.08) Setting range: 0.1–3600.0s	50%	○
P11.12	Underload pre-alarm detection time	Underload pre-alarm signal will be outputted if the output current of the VFD or motor is lower than underload pre-alarm detection level (P11.11), and the duration exceeds underload pre-alarm detection time (P11.12). Setting range: 0.1–3600.0s	1.0s	○
P11.13	Fault output terminal action upon fault occurring	Specifies the action of fault output terminals at undervoltage and fault reset. Setting range: 0x00–0x11 Ones place: 0: Act upon an undervoltage fault 1: Do not act upon an undervoltage fault Tens place:	0x00	○

Function code	Name	Description	Default	Modify
		0: Act during the automatic reset period 1: Do not act during the automatic reset period		
P11.14	Speed deviation detection value	Specifies the speed deviation detection value. Setting range: 0.0–50.0%	10.0%	<input type="radio"/>
P11.15	Speed deviation detection time	Specifies the speed deviation detection time. If the speed deviation detection time is smaller than the set value, the VFD continues running. Setting range: 0.0–10.0s  Note: Speed deviation protection is invalid when P11.15 is set to 0.0.	2.0s	<input type="radio"/>
P11.16	Automatic frequency-reduction during voltage drop	Setting range: 0–1 0: Disable 1: Valid	0	<input type="radio"/>
P11.17	Proportional coefficient of voltage regulator during undervoltage stall	Specifies the proportional coefficient of the bus voltage regulator during undervoltage stall. Setting range: 0–127	20	<input type="radio"/>
P11.18	Integral coefficient of voltage regulator during undervoltage stall	Specifies the integral coefficient of the bus voltage regulator during undervoltage stall. Setting range: 0–1000	5	<input type="radio"/>
P11.19	Proportional coefficient of current regulator	Specifies the proportional coefficient of the active current regulator during undervoltage stall. Setting range: 0–1000	20	<input type="radio"/>

Function code	Name	Description	Default	Modify
	during undervoltage stall			
P11.20	Integral coefficient of current regulator during undervoltage stall	Specifies the integral coefficient of the active current regulator during undervoltage stall. Setting range: 0–2000	20	<input type="radio"/>
P11.21	Proportional coefficient of voltage regulator during overvoltage stall	Specifies the proportional coefficient of the bus voltage regulator during overvoltage stall. Setting range: 0–127	60	<input type="radio"/>
P11.22	Integral coefficient of voltage regulator during overvoltage stall	Specifies the integral coefficient of the bus voltage regulator during overvoltage stall. Setting range: 0–1000	5	<input type="radio"/>
P11.23	Proportional coefficient of current regulator during overvoltage stall	Specifies the proportional coefficient of the active current regulator during overvoltage stall. Setting range: 0–1000	60	<input type="radio"/>
P11.24	Integral coefficient of current regulator during	Specifies the integral coefficient of the active current regulator during overvoltage stall. Setting range: 0–2000	250	<input type="radio"/>

Function code	Name	Description	Default	Modify
	overvoltage stall			
P11.25	VFD overload integral enabling	Setting range: 0–1 0: Disable. The overload timing value is reset to zero after the VFD is stopped. In this case, the determination of VFD overload takes more time, and therefore the effective protection over the VFD is weakened. 1: Enable. The overload timing value is not reset, and the overload timing value is accumulative. In this case, the determination of VFD overload takes less time, and therefore the protection over the VFD can be performed more quickly.	0	<input checked="" type="radio"/>
P11.26–P11.27	Reserved	-	-	-
P11.28	SPO switch-on detection delay time	Setting range: 0.0–60.0s  Note: The SPO detection is started only after the VFD runs for the delay time P11.28 to avoid false alarms caused by the unstable frequency.	5.0s	<input type="radio"/>
P11.29	SPO unbalance factor	Setting range: 0–10	6	<input type="radio"/>
P11.30–P11.32	Reserved	-	-	-

Group P13—SM control



Function code	Name	Description	Default	Modify
P13.00	SM injected-current decrease	Specifies the reduction rate of the input reactive current. When the active current of the synchronous	80.0%	<input type="radio"/>

Function code	Name	Description	Default	Modify
	ratio	motor increases to some extent, the input reactive current can be reduced to improve the power factor of the motor. Setting range: 0.0%–100.0% (of the motor rated current)		
P13.01	Detection mode of initial pole	Setting range: 0–2 0: No detection 1: Reserved 2: Pulse superposition	2	<input checked="" type="radio"/>
P13.02	Pull-in current 1	Specifies the pole position orientation current. It is valid within the lower limit of pull-in current switch-over frequency threshold. If you need to increase the start torque, increase the value of this function parameter properly. Setting range: -100.0%–100.0% (of the motor rated current)	30.0%	<input type="radio"/>
P13.03	Pull-in current 2	Specifies the pole position orientation current. It is valid within the upper limit of pull-in current switch-over frequency threshold. You do not need to change the value in most cases. Setting range: -100.0%–100.0% (of the motor rated current)	0.0%	<input type="radio"/>
P13.04	Switch-over frequency of pull-in current	Setting range: 0.0–200.0%  Note: The value is relative to the motor rated frequency.	20.0%	<input type="radio"/>
P13.05	SVC observer speed feedback bandwidth	Setting range: 10.0–200.0	62.5	<input checked="" type="radio"/>
P13.06	High-frequency superposition	Specifies the pulse current threshold when the initial magnetic pole position is detected in the	80.0%	<input checked="" type="radio"/>

Function code	Name	Description	Default	Modify
	voltage	pulse mode. The value is a percentage in relative to the rated current of the motor. Setting range: 0.0–300% (of the motor rated voltage)		
P13.07	Control parameter 0	Setting range: 0.0–400.0	0.0	<input type="radio"/>
P13.08	Control parameter 1	Setting range: 0x0000–0xFFFF	0x0000	<input type="radio"/>
P13.09	Reserved	-	-	-
P13.10	Initial compensation angle of SM	Setting range: 0.0–359.9	0.0	<input type="radio"/>
P13.11	Mal-adjustment detection time	Used to adjust the responsiveness of anti-maladjustment function. If the load inertia is large, increase the value of this parameter properly, however, the responsiveness may slow down accordingly. Setting range: 0.0–10.0s	0.5s	<input type="radio"/>
P13.12–P13.13	Reserved	-	-	-
P13.14	Deadzone compensation switching current permillage	0–1000	0	<input type="radio"/>
P13.15–P13.19	Reserved	-	-	-

Group P14—Serial communication

Function code	Name	Description	Default	Modify
P14.00	Local communication address	Setting range: 1–247 When the master writes the slave communication address to 0 indicating a broadcast address in a	1	<input type="radio"/>

Function code	Name	Description	Default	Modify
		<p>frame, all the slaves on the Modbus bus receive the frame but do not respond to it.</p> <p>The communication addresses on the communication network are unique, which is the basis of the point-to-point communication.</p> <p> Note: The slave address cannot be set to 0.</p>		
P14.01	Communication baud rate setting	<p>Specifies the data transmission speed between the host controller and the VFD.</p> <p>Setting range: 0–7</p> <p>0: 1200bps 1: 2400bps 2: 4800bps 3: 9600bps 4: 19200bps 5: 38400bps 6: 57600bps 7: 115200bps</p> <p> Note: The baud rate set on the VFD must be consistent with that on the host controller. Otherwise, the communication fails. A greater baud rate indicates faster communication.</p>	4	<input type="radio"/>
P14.02	Data bit check setting	<p>Setting range: 0–5</p> <p>0: No check (N, 8, 1) for RTU 1: Even check (E, 8, 1) for RTU 2: Odd check (O, 8, 1) for RTU 3: No check (N, 8, 2) for RTU 4: Even check (E, 8, 2) for RTU 5: Odd check (O, 8, 2) for RTU</p> <p> Note: The data format set on the VFD must be consistent with that on the host controller. Otherwise, the communication fails.</p>	1	<input type="radio"/>
P14.03	Communication	Setting range: 0–200ms	5ms	<input type="radio"/>

Function code	Name	Description	Default	Modify
	n response delay			
P14.04	RS485 communication timeout period	Setting range: 0.0–60.0s  Note: When it is set to 0.0, the timeout is invalid.	0.0s	<input type="radio"/>
P14.05	Transmission fault processing	Setting range: 0–3 0: Report an alarm and coast to stop 1: Keep running without reporting an alarm 2: Stop in enabled stop mode without reporting an alarm (applicable only to communication mode) 3: Stop in enabled stop mode without reporting an alarm (applicable to any mode)	0	<input type="radio"/>
P14.06	Modbus communication processing action selection	Setting range: 0x000–0x111 Ones place: 0: Respond to write operations 1: Not respond to write operations Tens place: 0: Communication password protection is invalid. 1: Communication password protection is valid. Hundreds place: (valid for RS485 communication only) 0: User-defined addresses specified by P14.07 and P14.08 are invalid. 1: User-defined addresses specified by P14.07 and P14.08 are valid.	0x000	<input type="radio"/>
P14.07	User-defined running command address	Setting range: 0x0000–0xFFFF	0x2000	<input type="radio"/>
P14.08	User-defined frequency setting	Setting range: 0x0000–0xFFFF	0x2001	<input type="radio"/>

Function code	Name	Description	Default	Modify
	address			
P14.09	Monitoring variable address 1	Setting range: 0x0000–0xFFFF	0x0000	<input type="radio"/>
P14.10	Monitoring variable address 2	Setting range: 0x0000–0xFFFF	0x0000	<input type="radio"/>
P14.11	Monitoring variable address 3	Setting range: 0x0000–0xFFFF	0x0000	<input type="radio"/>
P14.12	Monitoring variable address 4	Setting range: 0x0000–0xFFFF	0x0000	<input type="radio"/>

Group P17—Status viewing

Function code	Name	Description	Default	Modify
P17.00	Set frequency	Displays the present set frequency of the VFD. Setting range: 0.00Hz–P00.03	0.00Hz	<input checked="" type="radio"/>
P17.01	Output frequency	Displays the present output frequency of the VFD. Setting range: 0.00Hz–P00.03	0.00Hz	<input checked="" type="radio"/>
P17.02	Ramp reference frequency	Displays the present ramp reference frequency of the VFD. Setting range: 0.00Hz–P00.03	0.00Hz	<input checked="" type="radio"/>
P17.03	Output voltage	Displays the present output voltage of the VFD. Setting range: 0–1200V	0V	<input checked="" type="radio"/>
P17.04	Output current	Displays the valid value of present output current of the VFD. Setting range: 0.00–500.00A	0.00A	<input checked="" type="radio"/>
P17.05	Motor rotation speed	Displays the present motor rotation speed. Setting range: 0–65535rpm	0rpm	<input checked="" type="radio"/>
P17.06	Torque	Displays the present torque current	0.00A	<input checked="" type="radio"/>

Function code	Name	Description	Default	Modify
	current	of the VFD. Setting range: -300.00–300.00A		
P17.07	Exciting current	Displays the present exciting current of the VFD. Setting range: -300.00–300.00A	0.00A	●
P17.08	Motor power	Displays the present motor power. 100% corresponds to the motor rated power. Setting Range: -300.0–300.0% (of the motor rated power)	0.0%	●
P17.09	Motor output torque	Displays the present output torque of the VFD. 100% corresponds to the motor rated torque. Setting range: -250.0–250.0%	0.0%	●
P17.10	Estimated motor frequency	Used to indicate the estimated motor rotor frequency under the open-loop vector condition. Setting range: 0.00–P00.03	0.00Hz	●
P17.11	DC bus voltage	Displays the present DC bus voltage of the VFD. Setting range: 0.0–2000.0V	0.0V	●
P17.12	Digital input terminal state	Displays the present digital input terminal state of the VFD. Setting range: 0x000–0x1FF The bits from high to low correspond to HDIA, S8, S7, S6, S5, S4, S3, S2, and S1 respectively.	0x000	●
P17.13	Digital output terminal state	Displays the present digital output terminal state of the VFD. Setting range: 0x00–0x0F The bits from high to low correspond to RO2, RO1, Reserved, and Y1 respectively.	0x00	●
P17.14	Digital adjustment value	Displays the adjustment on the VFD through the UP/DOWN terminal. Setting range: 0.00Hz–P00.03	0.00Hz	●
P17.15	Torque reference	Indicates the percentage of the rated torque of the present motor,	0.0%	●

Function code	Name	Description	Default	Modify
	value	displaying the torque reference. Setting range: -300.0%–300.0% (of the motor rated current)		
P17.16	Linear speed	0–65535	0	●
P17.17	Reserved	-	-	-
P17.18	Count value	0–65535	0	●
P17.19	AI1 input voltage	Displays the AI1 input signal. Setting range: 0.00–10.00V	0.00V	●
P17.20	AI2 input voltage	Displays the AI2 input signal. Setting range: 0.00V–10.00V	0.00V	●
P17.21	AI3 input voltage	Displays the AI3 input signal. Setting range: 0.00V–10.00V	0.00V	●
P17.22	HDIA input frequency	Displays the HDIA input frequency. Setting range: 0.000–50.000kHz	0.000 kHz	●
P17.23	PID reference value	Displays the PID reference value. Setting range: -100.0–100.0%	0.0%	●
P17.24	PID feedback value	Displays the PID feedback value. Setting range: -100.0–100.0%	0.0%	●
P17.25	Motor power factor	Displays the power factor of the present motor. Setting range: -1.00–1.00	0.00	●
P17.26	Duration of this run	Displays the duration of this run of the VFD. Setting range: 0–65535min	0min	●
P17.27	Present step of simple PLC	Displays the present step of the simple PLC function. Setting range: 0–15	0	●
P17.28	Motor ASR controller output	Displays the ASR controller output value as a percentage relative to the rated motor torque under the vector control mode. Setting range: -300.0%–300.0% (of the motor rated current)	0.0%	●
P17.29	Pole angle of open-loop SM	Displays the initial identification angle of SM. Setting range: 0.0–360.0	0.0	●
P17.30	Phase	Displays the phase compensation of	0.0	●

Function code	Name	Description	Default	Modify
	compensation of SM	SM. Setting range: -180.0-180.0		
P17.31	Reserved	-	-	-
P17.32	Motor flux linkage	0.0%-200.0%	0.0%	●
P17.33	Exciting current reference	Displays the exciting current reference value under the vector control mode. Setting range: -300.00-300.00A	0.00A	●
P17.34	Torque current reference	Displays the torque current reference value under the vector control mode. Setting range: -300.00-300.00A	0.00A	●
P17.35	Reserved	-	-	-
P17.36	Output torque	Displays the output torque value. During forward running, the positive value is the motoring state while the negative value is generating state. During reverse running, the positive value is the generating state while the negative value is the motoring state. Setting range: -3000.0Nm-3000.0Nm	0.0Nm	●
P17.37	Motor overload count value	Setting range: 0-65535	0	●
P17.38	Process PID output	Setting range: -100.0%-100.0%	0.0%	●
P17.39	Function code in parameter download error	Setting range: 0.00-99.00	0.00	●
P17.40	Motor control mode	Setting range: 0x000-0x122 Ones place: Control mode 0: Open-loop vector control 1: Reserved	0x000	●

Function code	Name	Description	Default	Modify
		2: VF control Tens place: Open-loop vector control mode 0: SVC0 1: SVC1 2: Reserved Hundreds place: Motor type 0: Asynchronous motor (AM) 1: Synchronous motor (SM)		
P17.41	Electromotive torque upper limit	Setting range: 0.0%–300.0% (of the motor rated current)	0.0%	●
P17.42	Braking torque upper limit	Setting range: 0.0%–300.0% (of the motor rated current)	0.0%	●
P17.43	Forward rotation upper-limit frequency in torque control	Setting range: 0.00– <u>P00.03</u>	0.00Hz	●
P17.44	Reverse rotation upper-limit frequency in torque control	Setting range: 0.00– <u>P00.03</u>	0.00Hz	●
P17.45	Inertia compensation torque	Setting range: -100.0%–100.0%	0.0%	●
P17.46	Friction compensation torque	Setting range: -100.0%–100.0%	0.0%	●
P17.47	Motor pole pairs	Setting range: 0–65535	0	●
P17.48	VFD overload count value	Setting range: 0–65535	0	●
P17.49	Frequency set by A source	Setting range: 0.00– <u>P00.03</u>	0.00Hz	●

Function code	Name	Description	Default	Modify
P17.50	Frequency set by B source	Setting range: 0.00– <u>P00.03</u>	0.00Hz	●
P17.51	PID proportional output	Setting range: -100.0%–100.0%	0.0%	●
P17.52	PID integral output	Setting range: -100.0%–100.0%	0.0%	●
P17.53	PID differential output	Setting range: -100.0%–100.0%	0.0%	●
P17.54	PID present proportional gain	Setting range: 0.00–100.00	0.00	●
P17.55	PID present integral gain	Setting range: 0.00–10.00s	0.00s	●
P17.56	PID present differential time	Setting range: 0.00–10.00s	0.00s	●
P17.57– P17.58	Reserved	-	-	-
P17.59	Monitoring variable 1	Setting range: 0–65535	0	●
P17.60	Monitoring variable 2	Setting range: 0–65535	0	●
P17.61	Monitoring variable 3	Setting range: 0–65535	0	●
P17.62	Monitoring variable 4	Setting range: 0–65535	0	●
P17.63	Reserved	-	-	-

Your Trusted Industry Automation Solution Provider



Shenzhen INVT Electric Co., Ltd.

Address: INVT Guangming Technology Building, Songbai Road, Matian,
Guangming District, Shenzhen, China

INVT Power Electronics (Suzhou) Co., Ltd.

Address: No. 1 Kunlun Mountain Road, Science & Technology Town,
Gaixin District, Suzhou, Jiangsu, China

Website: www.invt.com



INVT mobile website



INVT e-manual



6 6 0 0 1 - 0 1 1 8 1

Copyright© INVT.

Manual information may be subject to change without prior notice.

202309 (V1.1)